

PICO-MTU4

PICO-ITX Single Board Computer

User's Manual 1st Ed

Copyright Notice

This document is copyrighted, 2024. All rights are reserved. The original manufacturer reserves the right to make improvements to the products described in this manual at any time without notice.

No part of this manual may be reproduced, copied, translated, or transmitted in any form or by any means without the prior written permission of the original manufacturer. Information provided in this manual is intended to be accurate and reliable. However, the original manufacturer assumes no responsibility for its use, or for any infringements upon the rights of third parties that may result from its use.

The material in this document is for product information only and is subject to change without notice. While reasonable efforts have been made in the preparation of this document to assure its accuracy, AAEMON assumes no liabilities resulting from errors or omissions in this document, or from the use of the information contained herein.

AAEMON reserves the right to make changes in the product design without notice to its users.

Acknowledgement

All other products' name or trademarks are properties of their respective owners.

- Microsoft Windows® is a registered trademark of Microsoft Corp.
- Intel® is a registered trademark of Intel Corporation
- Intel® Core™ Ultra is a trademark of Intel Corporation
- ITE is a trademark of Integrated Technology Express, Inc.
- IBM, PC/AT, PS/2, and VGA are trademarks of International Business Machines Corporation.
- Ubuntu and Canonical are registered trademarks of Canonical Ltd.
- Linux® is the registered trademark of Linus Torvalds in the U.S. and other countries.

All other product names or trademarks are properties of their respective owners.

Omission of a product name from this list does not imply any claim to ownership by the publisher of this document.

Packing List

Before setting up your product, please make sure the following items have been shipped:

Item	Quantity
● PICO-MTU4	1

If any of these items are missing or damaged, please contact your distributor or sales representative immediately.

About this Document

This User's Manual contains all the essential information, such as detailed descriptions and explanations on the product's hardware and software features (if any), its specifications, dimensions, jumper/connector settings/definitions, and driver installation instructions (if any), to facilitate users in setting up their product.

Users may refer to the product page on AAEON.com for the latest version of this document.

Safety Precautions

Please read the following safety instructions carefully. It is advised that you keep this manual for future references

1. All cautions and warnings on the device should be noted.
2. Make sure the power source matches the power rating of the device.
3. Position the power cord so that people cannot step on it. Do not place anything over the power cord.
4. Always completely disconnect the power before working on the system's hardware.
5. No connections should be made when the system is powered as a sudden rush of power may damage sensitive electronic components.
6. If the device is not to be used for a long time, disconnect it from the power supply to avoid damage by transient over-voltage.
7. Always disconnect this device from any AC supply before cleaning.
8. While cleaning, use a damp cloth instead of liquid or spray detergents.
9. Make sure the device is installed near a power outlet and is easily accessible.
10. Keep this device away from humidity.
11. Place the device on a solid surface during installation to prevent falls
12. Do not cover the openings on the device to ensure optimal heat dissipation.
13. Watch out for high temperatures when the system is running.
14. Do not touch the heat sink or heat spreader when the system is running
15. Never pour any liquid into the openings. This could cause fire or electric shock.
16. As most electronic components are sensitive to static electrical charge, be sure to ground yourself to prevent static charge when installing the internal components. Use a grounding wrist strap and contain all electronic components in any static-shielded containers.

17. If any of the following situations arises, please the contact our service personnel:
 - i. Damaged power cord or plug
 - ii. Liquid intrusion to the device
 - iii. Exposure to moisture
 - iv. Device is not working as expected or in a manner as described in this manual
 - v. The device is dropped or damaged
 - vi. Any obvious signs of damage displayed on the device

18. **DO NOT LEAVE THIS DEVICE IN AN UNCONTROLLED ENVIRONMENT WHERE THE STORAGE TEMPERATURE IS BELOW -20° C (-4°F) OR ABOVE 60°C (140°F) TO PREVENT DAMAGE.**

Warning!



This device complies with Part 15 FCC Rules. Operation is subject to the following two conditions: (1) this device may not cause harmful interference, and (2) this device must accept any interference received including interference that may cause undesired operation.

Caution:

There is a danger of explosion if the battery is incorrectly replaced. Replace only with the same or equivalent type recommended by the manufacturer. Dispose of used batteries according to the manufacturer's instructions and your local government's recycling or disposal directives.

Attention:

Il y a un risque d'explosion si la batterie est remplacée de façon incorrecte. Ne la remplacer qu'avec le même modèle ou équivalent recommandé par le constructeur. Recycler les batteries usées en accord avec les instructions du fabricant et les directives gouvernementales de recyclage.

China RoHS Requirements (CN)

产品中有毒有害物质或元素名称及含量

AAEON Main Board/ Daughter Board/ Backplane

部件名称	有毒有害物质或元素					
	铅 (Pb)	汞 (Hg)	镉 (Cd)	六价铬 (Cr(VI))	多溴联苯 (PBB)	多溴二苯醚 (PBDE)
印刷电路板 及其电子组件	X	X	○	○	○	○
外部信号 连接器及线材	X	X	○	○	○	○
<p>○: 表示该有毒有害物质在该部件所有均质材料中的含量均在 SJ/T 11363-2006 标准规定的限量要求以下。</p> <p>X: 表示该有毒有害物质至少在该部件的某一均质材料中的含量超出 SJ/T 11363-2006 标准规定的限量要求。</p> <p>备注: 此产品所标示之环保使用期限, 系指在一般正常使用状况下。</p>						

China RoHS Requirement (EN)

Poisonous or Hazardous Substances or Elements in Products

AAEON Main Board/ Daughter Board/ Backplane

Component	Poisonous or Hazardous Substances or Elements					
	Lead (Pb)	Mercury (Hg)	Cadmium (Cd)	Hexavalent Chromium (Cr(VI))	Polybrominated Biphenyls (PBB)	Polybrominated Diphenyl Ethers (PBDE)
PCB & Other Components	X	X	O	O	O	O
Wires & Connectors for External Connections	X	X	O	O	O	O
<p>O: The quantity of poisonous or hazardous substances or elements found in each of the component's parts is below the SJ/T 11363-2006-stipulated requirement.</p> <p>X: The quantity of poisonous or hazardous substances or elements found in at least one of the component's parts is beyond the SJ/T 11363-2006-stipulated requirement.</p> <p>Note: The Environment Friendly Use Period as labeled on this product is applicable under normal usage only</p>						

Table of Contents

Chapter 1 - Product Specifications	1
1.1 Specifications.....	2
1.2 Function Block Diagram.....	5
Chapter 2 – Hardware Information	6
2.1 Dimensions.....	7
2.2 Jumpers and Connectors	9
2.3 List of Jumpers.....	11
2.3.1 Clear CMOS Jumper & Auto Power Button Enable/Disable (JP1).....	11
2.4 List of Connectors.....	12
2.4.1 USB 2.0 Connector (CN1/CN2).....	13
2.4.2 M.2 2230 E-Key (CN3).....	13
2.4.3 Front Panel (CN4).....	16
2.4.4 M.2 2280 M-Key (CN5)	16
2.4.5 COM Connector (CN6)	19
2.4.6 SATA Port (CN7).....	21
2.4.7 HDMI Port (CN8).....	22
2.4.8 RJ-45 LAN Port 1/Port 2 (CN9).....	23
2.4.9 +5V Output for SATA HDD (CN10).....	24
2.4.10 RTC Battery Connector (CN11).....	24
2.4.11 USB 3.2/USB 2.0 Port 1/Port 2 (CN12).....	25
2.4.12 External Power Input (CN13)	26
2.4.13 eDP Connector (CN15).....	26
2.4.14 IMVP9 Programming Port (CN16).....	28
2.4.15 I2C/SMBus Connector (CN17).....	28
2.4.16 SPI Flash Programming Port (CN18).....	29
2.4.17 Port 80 Debug Port Connector (CN19).....	29

2.4.18	GPIO Connector (CN20).....	30
2.4.19	4-pin Fan Connector (CN21).....	30
2.5	Thermal Assembly Options.....	32
2.5.1	Fan Assembly	32
Chapter 3	- AMI BIOS Setup	33
3.1	System Test and Initialization	34
3.2	AMI BIOS Setup.....	35
3.3	Setup Submenu: Main.....	36
3.4	Setup Submenu: Advanced	37
3.4.1	CPU Configuration	38
3.4.2	Memory Configuration	39
3.4.3	Hardware Monitor	40
3.4.3.1	Smart Fan Mode Configuration.....	41
3.4.4	PCH-FW Configuration	42
3.4.5	Power Management	43
3.4.6	AAEON BIOS Robot.....	44
3.4.7	Device Detecting Configuration.....	46
3.4.7.1	Device #1 ~ #5 Detecting Configuration	47
3.4.8	AAEON Smart Boost	48
3.5	Setup Submenu: System I/O	49
3.5.1	Storage Configuration.....	50
3.5.2	NVMe Configuration	51
3.5.3	SATA Configuration	53
3.5.4	GPIO Port Configuration.....	54
3.5.5	SIO Configuration	55
3.5.5.1	Serial Port 1 Configuration.....	56
3.5.5.2	Serial Port 2 Configuration	57
3.5.6	Serial Port Console Redirection.....	58

3.5.7	Serial IO Configuration.....	59
3.6	Setup Submenu: Security	60
3.6.1	Trusted Computing	61
3.6.2	Secure Boot	63
3.6.3	Expert Key Management	64
3.7	Setup Submenu: Boot	66
3.7.1	BBS Priorities.....	67
3.8	Setup Submenu: Save & Exit	69
3.9	Setup Submenu: MEBx.....	70
3.9.1	Intel® AMT Configuration	71
3.9.2	Redirection Features	72
3.9.3	User Consent.....	73
3.9.4	Network Setup	74
3.9.5	Intel® ME Network Name Settings.....	75
3.9.6	TCP/IP Settings.....	76
3.9.7	Remote Setup and Configuration.....	77
3.9.8	Power Control	78
Chapter 4	– Driver Installation	79
4.1	Driver Download/Installation	80
Appendix A	– Mating Connectors	83
A.1	List of Mating Connectors and Cables	84
Appendix B	- I/O Information	85
B.1	I/O Address Map.....	86
B.2	IRQ Mapping Chart	87
B.3	Memory Address Map	96

Chapter 1

Product Specifications

1.1 Specifications

System

Form Factor	PICO-ITX
CPU	Intel® Core™ Ultra 7/Ultra 5 SoC Intel® Core™ Ultra 7 Processor 165U (2PC+10EC/14T, P core 1.70 GHz, E core 1.20 GHz, 15W) Intel® Core™ Ultra 7 Processor 155U (2PC+10EC/14T, P core 1.70 GHz, E core 1.20 GHz, 15W) Intel® Core™ Ultra 5 Processor 135U (2PC+10EC/14T, P core 1.60 GHz, E core 1.10 GHz, 15W) Intel® Core™ Ultra 5 Processor 125U (2PC+10EC/14T, P core 1.30 GHz, E core 0.80 GHz, 15W)
Chipset	Integrated with Intel® SoC
Memory Type	Single-Channel LPDDR5 6400, up to 32GB
BIOS	UEFI
Wake on LAN	Yes
Watchdog Timer	255 Levels
Security	TPM 2.0
RTC Battery	Lithium Battery 3V/240mAh
Dimension	3.94" x 2.84" (100mm x 72mm)
Gross Weight	0.18 lb. (0.08Kg)
OS Support	Windows 10 (64-bit) Linux Ubuntu 22.04.2 kernel 5.19.0-32-generic

Power

Power Requirement	12V
Power Supply Type	AT/ATX
Connector	Phoenix 2-pin Connector (Default) Lockable DC Jack Connector (colay)
Power Consumption	Intel® Core™ Ultra 7 Processor 165U, DDR5 32GB x 1, 2.94A @+12V (Typical) Intel® Core™ Ultra 7 Processor 165U, DDR5 32GB x 1, 5.13A @+12V (Max)

Display

Controller	Intel® Graphics
LVDS/eDP	eDP 1.4 x 1
Display Interface	HDMI 1.4 x 1, 3840 x 2160 @30Hz
Multiple Display	Up to 2 Simultaneous Displays

Audio

Codec	—
Audio Interface	—
Speaker	—

External I/O

Ethernet	Intel® Ethernet Controller I226, 2.5GbE, RJ-45 x 1 Intel® Ethernet Connection I219, 1GbE, RJ-45 x 1
USB	USB 3.2 Gen 2 x 2
Serial Port	—
Video	HDMI 1.4 x 1

Internal I/O

USB	USB 2.0 x 2
Serial Port	COM 1~2 (RS-232/422/485, supports 5V/12V/RI, select by BOM)
Video	—
SATA	SATA 6Gb/s x 1 +5V SATA Power Connector x 1
Audio	—
DIO/GPIO	4-bit GPIO
SMBus/I2C	I2C/SMBus (Default: SMBus)
Touch	—
FAN	4-pin Smart Fan x 1
SIM	—
Front Panel	HDD LED, PWR LED, Power Button, Buzzer, Reset

Expansion

Mini PCIe/mSATA	—
M.2	M.2 2280 M-Key x 1 (PCIe 4.0 [x4]/SATA, Default: PCIe [x4], select by BOM) M.2 2230 E-Key x 1 (PCIe 4.0 [x1] + USB 2.0)

Environmental

Operating Temperature	-4°F ~ 158°F (-20°C ~ 70°C)
Storage Temperature	-40°F ~ 185°F (-40°C ~ 85°C)
Operating Humidity	0% ~ 90% relative humidity, non-condensing
MTBF (Hours)	1,063,716
EMC	CE/FCC Class A

1.2 Function Block Diagram

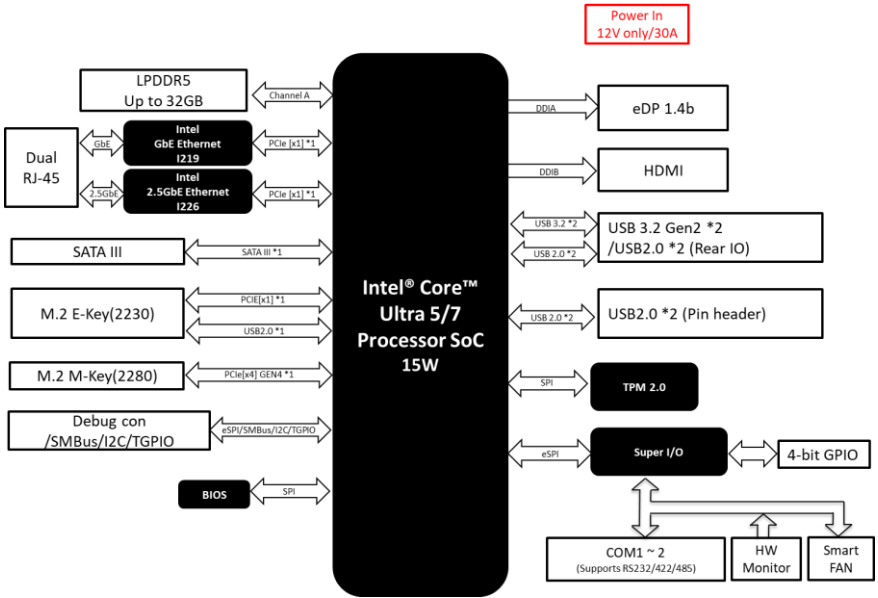

Chapter 2

Hardware Information

2.1 Dimensions

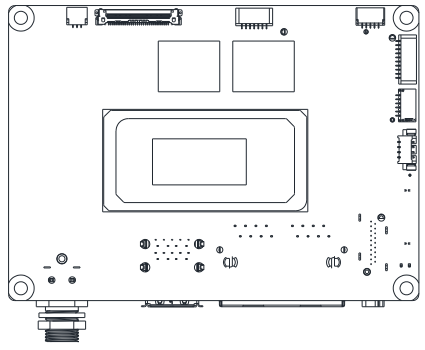
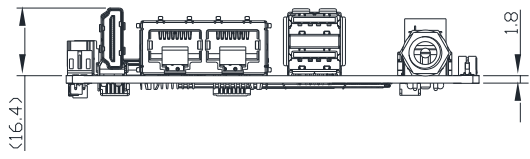
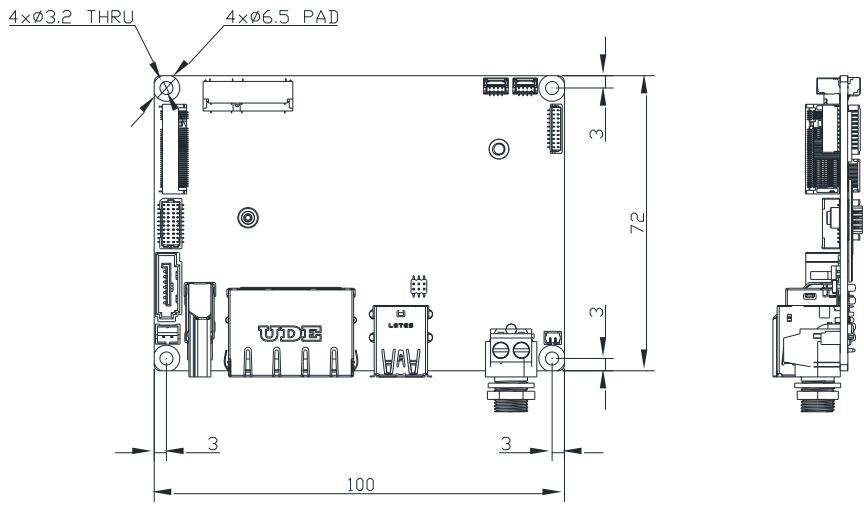

With Phoenix 2-pin Connector (Default)

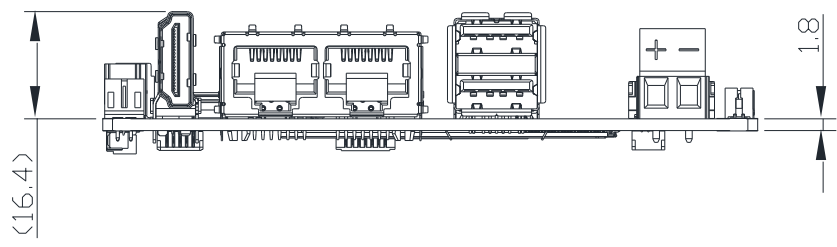

With Lockable DC Jack Connector (Colay)

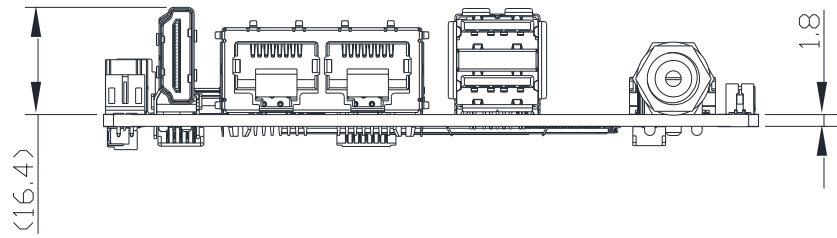

2.2 Jumpers and Connectors

Component Side:

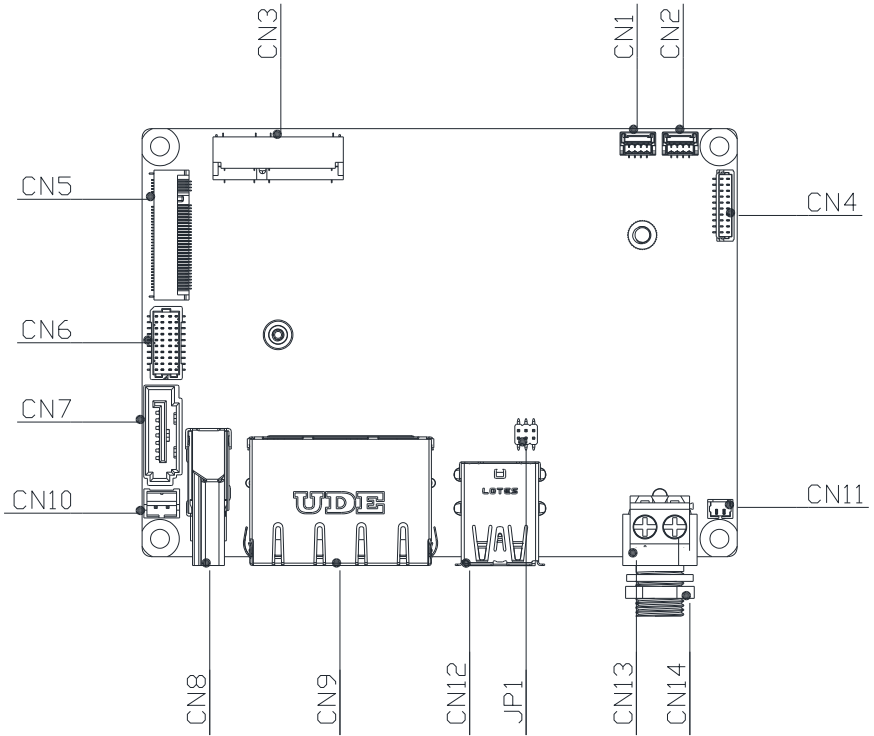

Solder Side:

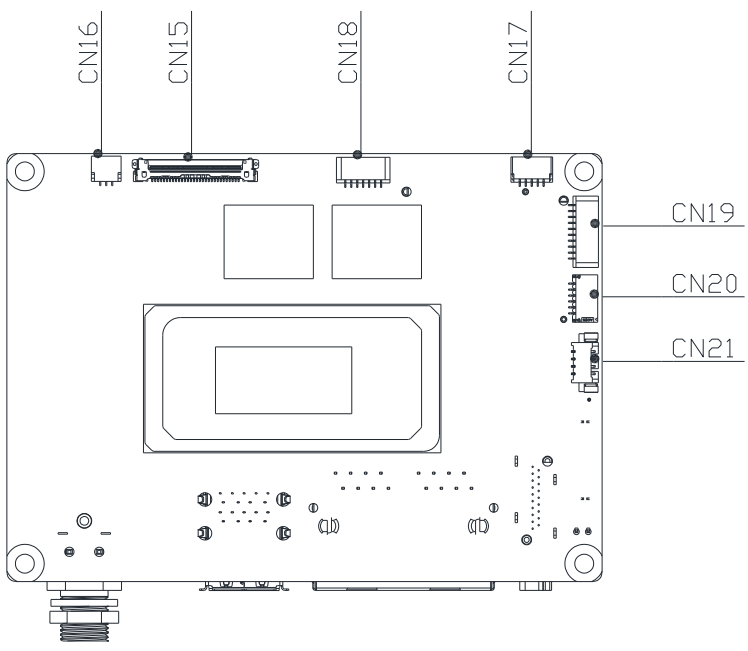

2.3 List of Jumpers

Jumpers allow users to manually customize system configurations to their suitable application needs.

Please refer to the table below for all of the board's jumpers that you can configure for your application

Label	Function
JP1 (Pins 1,3,5)	Clear CMOS Jumper
JP1 (Pins 2,4,6)	Auto Power Button Enable/Disable Selection

2.3.1 Clear CMOS Jumper & Auto Power Button Enable/Disable (JP1)

Clear CMOS Jumper:

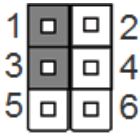

Normal (Default)

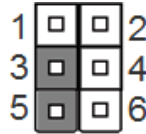

Clear CMOS

Auto Power Button Enable/Disable Selection:

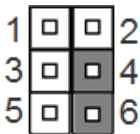

Enable Auto Power Button (Default)

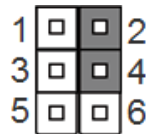

Disable Auto Power Button

Note: To avoid damage to the system, do not connect pins 1,3,5 with pins 2,4,6.

2.4 List of Connectors

Please refer to the table below for all of the board's connectors that you can configure for your application

Label	Function
CN1	USB 2.0 Connector
CN2	USB 2.0 Connector
CN3	M.2 2230 E-Key
CN4	Front Panel
CN5	M.2 2280 M-Key
CN6	COM Connector
CN7	SATA Port
CN8	HDMI Port
CN9	RJ-45 LAN Port 1/Port 2
CN10	+5V Output for SATA HDD
CN11	RTC Battery Connector
CN12	USB 3.2/USB 2.0 Port 1/Port 2
CN13	Terminal Block DC Input Connector
CN14	DC Jack
CN15	eDP Connector
CN16	IMVP9 Programming Port
CN17	I2C/SMBus Connector
CN18	SPI Flash Programming Port
CN19	Port 80 Debug Port Connector
CN20	GPIO Connector
CN21	4-pin Fan Connector

2.4.1 USB 2.0 Connector (CN1/CN2)

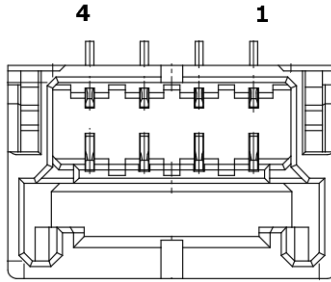

Pin	Pin Name	Signal Type	Signal Level
1	+5VSB	PWR	+5V
2	USB2_6_DN	DIFF	-
3	USB2_6_DP	DIFF	-
4	GND	GND	GND

2.4.2 M.2 2230 E-Key (CN3)

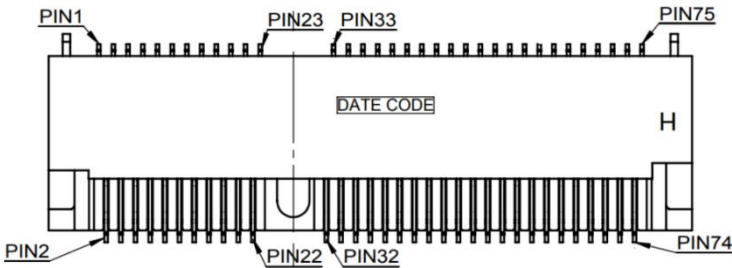

Pin	Pin Name	Signal Type	Signal Level
1	GND	GND	GND
2	+V3P3A	PWR	+3.3V
3	USB2_10_DP	DIFF	-
4	+V3P3A	PWR	+3.3V
5	USB2_10_DN	DIFF	-
6	NC	-	-

Pin	Pin Name	Signal Type	Signal Level
7	GND	GND	GND
8	NC	-	-
9	CNV_WR_D1_DN	DIFF	-
10	KEYE_CNV_RF_RST	IN	-
11	CNV_WR_D1_DP	DIFF	-
12	NC	-	-
13	GND	GND	GND
14	KEYE_CNV_CLKREQ	OUT	-
15	CNV_WR_D0_DN	DIFF	-
16	NC	-	-
17	CNV_WR_D0_DP	DIFF	-
18	GND	GND	GND
19	GND	GND	GND
20	KEYE_UART_WAKE_N	IN	-
21	CNV_WR_CLK_DN	DIFF	-
22	CNV_BRI_RSP	IN	-
23	CNV_WR_CLK_DP	DIFF	-
32	CNV_RGI_DT	IN	-
33	GND	GND	GND
34	CNV_RGI_RSP	OUT	-
35	PCIE_8_TXP	DIFF	-
36	CNV_BRI_DT	-	-
37	PCIE_8_TXN	DIFF	-
38	MLK_RST_N	IN	-
39	GND	GND	GND
40	MLK_DATA	IN/OUT	-
41	PCIE_8_RXP	DIFF	-
42	MLK_CLK	IN	-
43	PCIE_8_RXN	DIFF	-
44	NC	-	-
45	GND	GND	GND
46	NC	-	-
47	PCIE_3_CLK_DP	DIFF	-

Pin	Pin Name	Signal Type	Signal Level
48	NC	-	-
49	PCIE_3_CLK_DN	DIFF	-
50	SUS_CLK	IN	-
51	GND	GND	GND
52	BUF_PLT_RST#	IN	-
53	PCIE_CLKREQ#3	OUT	-
54	NC	-	-
55	PCIE_WAKE#	IN/OUT	-
56	NC	-	-
57	GND	GND	GND
58	NC	-	-
59	CNV_WT_D1_DN	DIFF	-
60	NC	-	-
61	CNV_WT_D1_DP	DIFF	-
62	NC	-	-
63	GND	GND	GND
64	NC	-	-
65	CNV_WT_D0_DN	DIFF	-
66	NC	-	-
67	CNV_WT_D0_DP	DIFF	-
68	NC	-	-
69	GND	GND	GND
70	NC	-	-
71	CNV_WT_CLK_DN	DIFF	-
72	+V3P3A	PWR	+3.3V
73	CNV_WT_CLK_DP	DIFF	-
74	+V3P3A	PWR	+3.3V
75	GND	GND	GND

2.4.3 Front Panel (CN4)

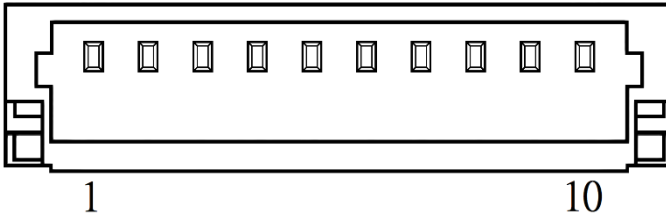

Pin	Pin Name	Signal Type	Signal Level
1	GND	GND	GND
2	EXT_PWRBTN#	IN	-
3	SATA_LED-	OUT	-
4	SATA_LED+	OUT	-
5	BUZZER-	OUT	-
6	BUZZER+	OUT	-
7	GND	GND	GND
8	PWR_LED+	OUT	-
9	GND	GND	GND
10	HWRST#	IN	-

2.4.4 M.2 2280 M-Key (CN5)

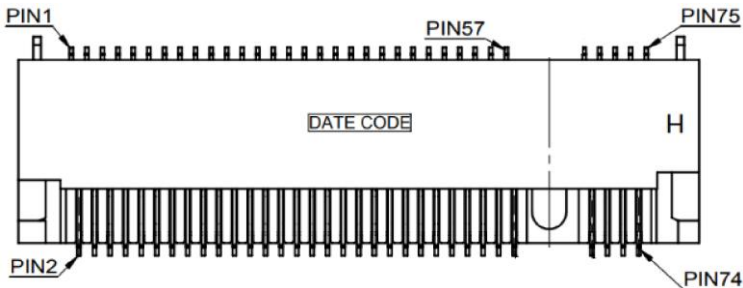

Pin	Pin Name	Signal Type	Signal Level
1	GND	GND	GND
2	+V3P3S	PWR	+3.3V

Pin	Pin Name	Signal Type	Signal Level
3	GND	GND	GND
4	+V3P3S	PWR	+3.3V
5	PCIE_12_RXN	DIFF	-
6	CARD_PWR_OFF_N	IN	-
7	PCIE_12_RXP	DIFF	-
8	NC	-	-
9	GND	GND	GND
10	PCH_SATA_LED_N	OUT	+3.3V
11	PCIE_12_TXN	DIFF	-
12	+V3P3S	PWR	+3.3V
13	PCIE_12_TXP	DIFF	-
14	+V3P3S	PWR	+3.3V
15	GND	GND	GND
16	+V3P3S	PWR	+3.3V
17	PCIE_11_RXN	DIFF	-
18	+V3P3S	PWR	+3.3V
19	PCIE_11_RXP	DIFF	-
20	NC	-	-
21	GND	GND	GND
22	KEYM_SSD_VIO	IN	-
23	PCIE_11_TXN	DIFF	-
24	NC	-	-
25	PCIE_11_TXP	DIFF	-
26	NC	-	-
27	GND	GND	GND
28	NC	-	-
29	PCIE_10_RXN	DIFF	-
30	NC	-	-
31	PCIE_10_RXP	DIFF	-
32	NC	-	-
33	GND	GND	GND
34	NC	-	-
35	PCIE_10_TXN	DIFF	-

Pin	Pin Name	Signal Type	Signal Level
36	NC	-	-
37	PCIE_10_TXP	DIFF	-
38	NC	-	-
39	GND	GND	GND
40	NC	-	-
41	PCIE_9_RXN/ SATA_1_RXP	DIFF	-
42	NC	-	-
43	PCIE_9_RXP/ SATA_1_RXN	DIFF	-
44	NC	-	-
45	GND	GND	GND
46	NC	-	-
47	PCIE_9_TXN/ SATA_1_TXN	DIFF	-
48	NC	-	-
49	PCIE_9_TXP/SATA_1_TX P	DIFF	-
50	BUF_PLT_RST#	IN	-
51	GND	GND	GND
52	M2M_CLKREQ#	OUT	-
53	PCIE_5_CLK_DN	DIFF	-
54	PCIE_WAKE#	OUT	-
55	PCIE_5_CLK_DP	DIFF	-
56	NC	-	-
57	GND	GND	GND
58	NC	-	-
67	NC	-	-
68	SUS_CLK	IN	-
69	KEYM_DET	IN	-
70	+V3P3S	PWR	+3.3V
71	GND	GND	GND
72	+V3P3S	PWR	+3.3V
73	GND	GND	GND

Pin	Pin Name	Signal Type	Signal Level
74	+V3P3S	PWR	+3.3V
75	GND	GND	GND

2.4.5 COM Connector (CN6)

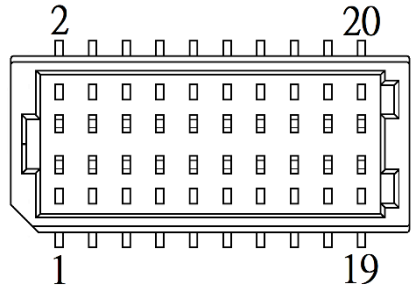

COM Port 1/Port 2 RS-232 (Default)

Pin	Pin Name	Signal Type	Signal Level
1	DCD1	IN	-
2	DCD2	IN	-
3	RX1	IN	-
4	RX2	IN	-
5	TX1	OUT	±9V
6	TX2	OUT	±9V
7	DTR1	OUT	±9V
8	DTR2	OUT	±9V
9	GND	GND	GND
10	GND	GND	GND
11	DSR1	IN	-
12	DSR2	IN	-
13	RTS1	OUT	±9V
14	RTS2	OUT	±9V
15	CTS1	IN	-
16	CTS2	IN	-
17	RI1/ +5V/ +12V	IN/ PWR	+5V/+12V
18	RI2/ +5V/ +12V	IN/ PWR	+5V/+12V

COM Port 1/Port 2 RS-232 (Default)			
Pin	Pin Name	Signal Type	Signal Level
19	NC	NC	NC
20	NC	NC	NC

COM Port 1 RS-422			
Pin	Pin Name	Signal Type	Signal Level
9	GND	GND	GND
1	RS422_TX-	OUT	±9V
3	RS422_TX+	OUT	±9V
5	RS422_RX+	IN	-
7	RS422_RX-	IN	-

COM Port 1 RS-485			
Pin	Pin Name	Signal Type	Signal Level
9	GND	GND	GND
1	RS485_D-	IN/OUT	±9V
3	RS485_D+	IN/OUT	±9V

Note: COM 1 RS-232/422/485 can be set by BIOS setting. Default is RS-232.

COM Port 2 RS-422			
Pin	Pin Name	Signal Type	Signal Level
10	GND	GND	GND
2	RS422_TX-	OUT	±9V
4	RS422_TX+	OUT	±9V
6	RS422_RX+	IN	-
8	RS422_RX-	IN	-

COM Port 2 RS-485

Pin	Pin Name	Signal Type	Signal Level
10	GND	GND	GND
2	RS485_D-	IN/OUT	±9V
4	RS485_D+	IN/OUT	±9V

Note: COM 2 RS-232/422/485 can be set by BIOS setting. Default is RS-232.

2.4.6 SATA Port (CN7)

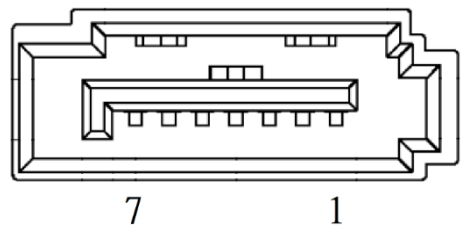

Pin	Pin Name	Signal Type	Signal Level
1	GND	GND	GND
2	SATA_TXP	DIFF	-
3	SATA_TXN	DIFF	-
4	GND	GND	GND
5	SATA_RXN	DIFF	-
6	SATA_RXP	DIFF	-
7	GND	GND	GND

2.4.7 HDMI Port (CN8)

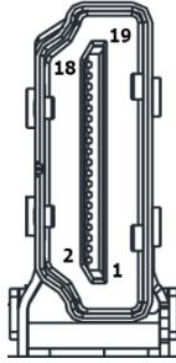

Pin	Pin Name	Signal Type	Signal Level
1	HDMI_TX2+	DIFF	-
2	GND	GND	GND
3	HDMI_TX2-	DIFF	-
4	HDMI_TX1+	DIFF	-
5	GND	GND	GND
6	HDMI_TX1-	DIFF	-
7	HDMI_TX0+	DIFF	-
8	GND	GND	GND
9	HDMI_TX0-	DIFF	-
10	HDMI_CLK+	DIFF	-
11	GND	GND	GND
12	HDMI_CLK-	DIFF	-
13	N/A	N/A	N/A
14	N/A	N/A	N/A
15	DDC_CLK	IN/OUT	-
16	DDC_DATA	IN/OUT	-
17	GND	GND	GND
18	+VSS	PWR	+5V
19	HDMI_HPD	IN	-

2.4.8 RJ-45 LAN Port 1/Port 2 (CN9)

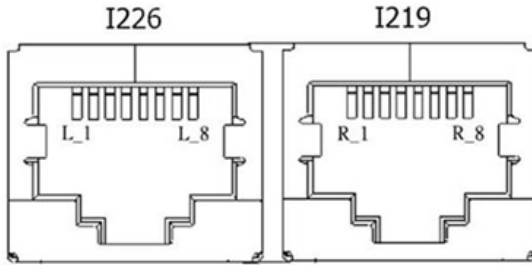

Pin	Pin Name	Signal Type	Signal Level
L_1	LAN1_MDI0_P	DIFF	-
L_2	LAN1_MDI0_N	DIFF	-
L_3	LAN1_MDI1_P	DIFF	-
L_4	LAN1_MDI1_N	DIFF	-
L_5	LAN1_MDI2_P	DIFF	-
L_6	LAN1_MDI2_N	DIFF	-
L_7	LAN1_MDI3_P	DIFF	-
L_8	LAN1_MDI3_N	DIFF	-
R_1	LAN2_MDI0_P	DIFF	-
R_2	LAN2_MDI0_N	DIFF	-
R_3	LAN2_MDI1_P	DIFF	-
R_4	LAN2_MDI1_N	DIFF	-
R_5	LAN2_MDI2_P	DIFF	-
R_6	LAN2_MDI2_N	DIFF	-
R_7	LAN2_MDI3_P	DIFF	-
R_8	LAN2_MDI3_N	DIFF	-

2.4.9 +5V Output for SATA HDD (CN10)

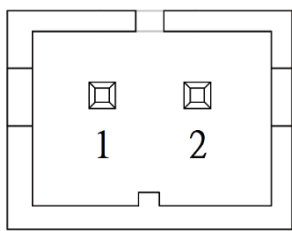

Pin	Pin Name	Signal Type	Signal Level
1	+V5S	PWR	+5V
2	GND	GND	GND

Note: The driving current of +V5S supports up to 2A.

2.4.10 RTC Battery Connector (CN11)

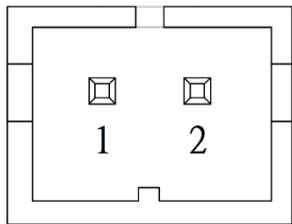

Pin	Pin Name	Signal Type	Signal Level
1	+3.3V	PWR	+3.3V
2	GND	GND	GND

2.4.11 USB 3.2/USB 2.0 Port 1/Port 2 (CN12)

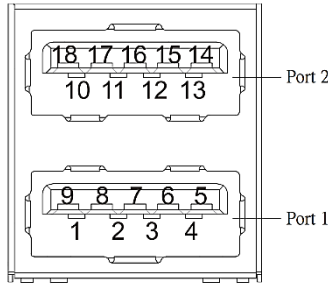

Pin	Pin Name	Signal Type	Signal Level
1	+5VSB	PWR	+5V
2	USB2_1_DN	DIFF	-
3	USB2_1_DP	DIFF	-
4	GND	GND	GND
5	USB3_1_RXN	DIFF	-
6	USB3_1_RXP	DIFF	-
7	GND	GND	GND
8	USB3_1_TXN	DIFF	-
9	USB3_1_TXP	DIFF	-
10	+5VSB	PWR	+5V
11	USB2_8_DN	DIFF	-
12	USB2_8_DP	DIFF	-
13	GND	GND	GND
14	USB3_2_RXN	DIFF	-
15	USB3_2_RXP	DIFF	-
16	GND	GND	GND
17	USB3_2_TXN	DIFF	-
18	USB3_2_TXP	DIFF	-

Note: The driving current of +5VSB supports up to 0.9A/Port.

2.4.12 External Power Input (CN13)

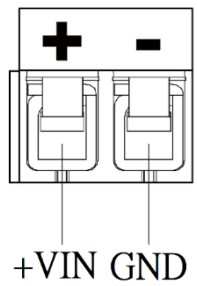

Pin	Pin Name	Signal Type	Signal Level
1	+VIN	PWR	+12V or +9~+36V
2	GND	GND	GND

2.4.13 eDP Connector (CN15)

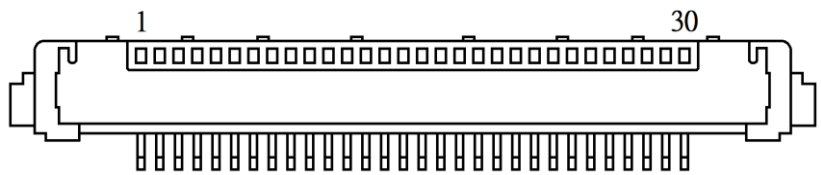

Pin	Pin Name	Signal Type	Signal Level
1	+VCC_EDP_BKLT	PWR	+12V
2	+VCC_EDP_BKLT	PWR	+12V
3	+VCC_EDP_BKLT	PWR	+12V
4	+VCC_EDP_BKLT	PWR	+12V
5	GND	GND	GND
6	GND	GND	GND
7	GND	GND	GND
8	EDP_HPD	-	-
9	EDP_BKLT_EN	-	-
10	NC	-	-
11	EDP_BKLTCTL	-	-

Pin	Pin Name	Signal Type	Signal Level
12	GND	GND	GND
13	EDP_AUX_DP	DIFF	-
14	EDP_AUX_DN	DIFF	-
15	GND	GND	GND
16	EDP_LANE3_DP	DIFF	-
17	EDP_LANE3_DN	DIFF	-
18	GND	GND	GND
19	EDP_LANE0_DP	DIFF	-
20	EDP_LANE0_DN	DIFF	-
21	GND	GND	GND
22	EDP_LANE1_DP	DIFF	-
23	EDP_LANE1_DN	DIFF	-
24	GND	GND	GND
25	EDP_LANE2_DP	DIFF	-
26	EDP_LANE2_DN	DIFF	-
27	GND	GND	GND
28	+VDD	PWR	+3.3V
29	+VDD	PWR	+3.3V
30	+VDD	PWR	+3.3V

Note: The driving current of +VCC_EDP_BKLT supports up to 1.2A.

Note: The driving current of +VDD supports up to 1A.

2.4.14 IMVP9 Programming Port (CN16)

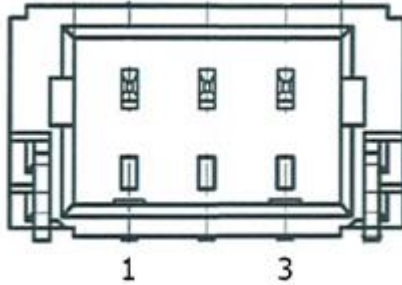

Pin	Pin Name	Signal Type	Signal Level
1	PM_SDA	IN/OUT	+3.3V
2	PM_SCL	IN	+3.3V
3	GND	GND	GND

2.4.15 I2C/SMBus Connector (CN17)

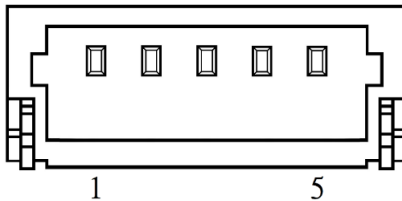

Pin	Pin Name	Signal Type	Signal Level
1	+V3P3S	PWR	+3.3V
2	SMB_CLK/ I2C_CLK/TIME_SYNC0	OUT	+3.3V
3	SMB_DAT/ I2C_DAT/TIME_SYNC1	IN/OUT	+3.3V
4	SMB_ALERT/ INT_SERIRQ/LAN_SDP	IN	+3.3V
5	GND	GND	GND

Note: Default function is SMBus.

2.4.16 SPI Flash Programming Port (CN18)

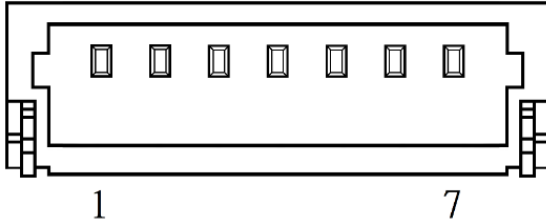

Pin	Pin Name	Signal Type	Signal Level
1	SPI_MISO	OUT	-
2	GND	GND	GND
3	SPI_CLK	IN	-
4	+V3P3A_SPI	PWR	+3.3V
5	SPI_MOSI	IN	-
6	SPI_CS	IN	-
7	NC	-	-

2.4.17 Port 80 Debug Port Connector (CN19)

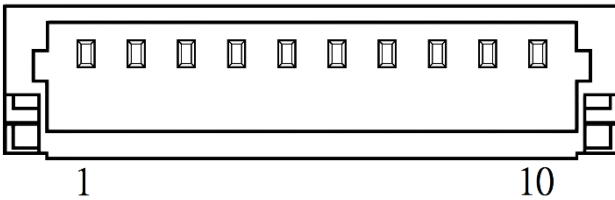

Pin	Pin Name	Signal Type	Signal Level
1	ESPI_IO0_EC_R	IN/OUT	+3.3V
2	ESPI_IO1_EC_R	IN/OUT	+1.8V
3	ESPI_IO2_EC_R	IN/OUT	+1.8V
4	ESPI_IO3_EC_R	IN/OUT	+1.8V
5	+V3P3S	PWR	+3.3V
6	ESPI_CS_EC_R_N	OUT	+3.3V
7	ESPI_RST_EC_R_N	OUT	+1.8V

Pin	Pin Name	Signal Type	Signal Level
8	GND	GND	GND
9	ESPI_CLK_EC_R	OUT	+1.8V
10	+V3P3A	PWR	+3.3V

2.4.18 GPIO Connector (CN20)

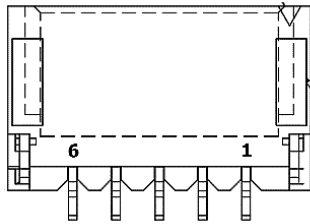

Pin	Pin Name	Signal Type	Signal Level
1	+V5S	PWR	+5V
2	GPIO_0	IN/OUT	-
3	GPIO_1	IN/OUT	-
4	GPIO_2	IN/OUT	-
5	GPIO_3	IN/OUT	-
6	GND	GND	GND

2.4.19 4-pin Fan Connector (CN21)

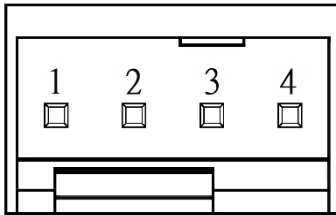

Pin	Pin Name	Signal Type	Signal Level
1	GND	GND	GND
2	FAN_POWER	PWR	+12V

Pin	Pin Name	Signal Type	Signal Level
3	FAN_TAC	IN	-
4	FAN_CTL	OUT	-

Note: The driving current of FAN_POWER supports up to 1A.

2.5 Thermal Assembly Options

2.5.1 Fan Assembly

Fan Part Number: PICO-MTU4-FAN01.

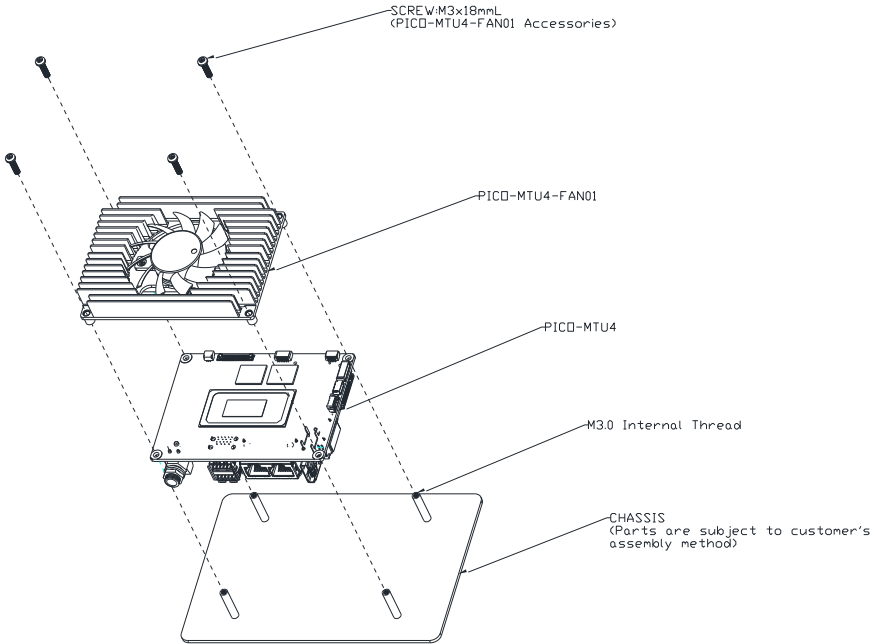

Chapter 3

AMI BIOS Setup

3.1 System Test and Initialization

These routines test and initialize board hardware. If the routines encounter an error during the tests, you will either hear a few short beeps or see an error message on the screen. There are two kinds of errors: fatal and non-fatal. The system can usually continue the boot up sequence with non-fatal errors.

System configuration verification

These routines check the current system configuration stored in the CMOS memory and BIOS NVRAM. If system configuration is not found or system configuration data error is detected, system will load optimized default and re-boot with this default system configuration automatically.

There are four situations in which you will need to setup system configuration:

1. You are starting your system for the first time
2. You have changed the hardware attached to your system
3. The system configuration is reset by Clear-CMOS jumper
4. The CMOS memory has lost power and the configuration information has been erased.

The PICO-MTU4 CMOS memory has an integral lithium battery backup for data retention. However, you will need to replace the complete unit when it finally runs down.

3.2 AMI BIOS Setup

AMI BIOS ROM has a built-in Setup program that allows users to modify the basic system configuration. This type of information is stored in battery-backed CMOS RAM and BIOS NVRAM so that it retains the Setup information when the power is turned off.

Entering Setup

Power on the computer and press or <ESC> immediately. This will allow you to enter Setup.

Main

Set the date, use tab to switch between date elements.

Advanced

Enable/disable the feature configurations.

System I/O

Host bridge parameters.

Security

Set setup administrator password.

Boot

Enables/disable quiet boot option.

Save & Exit

Exit system setup after saving the changes.

MEBx

Enables/disable MEBx option.

3.3 Setup Submenu: Main

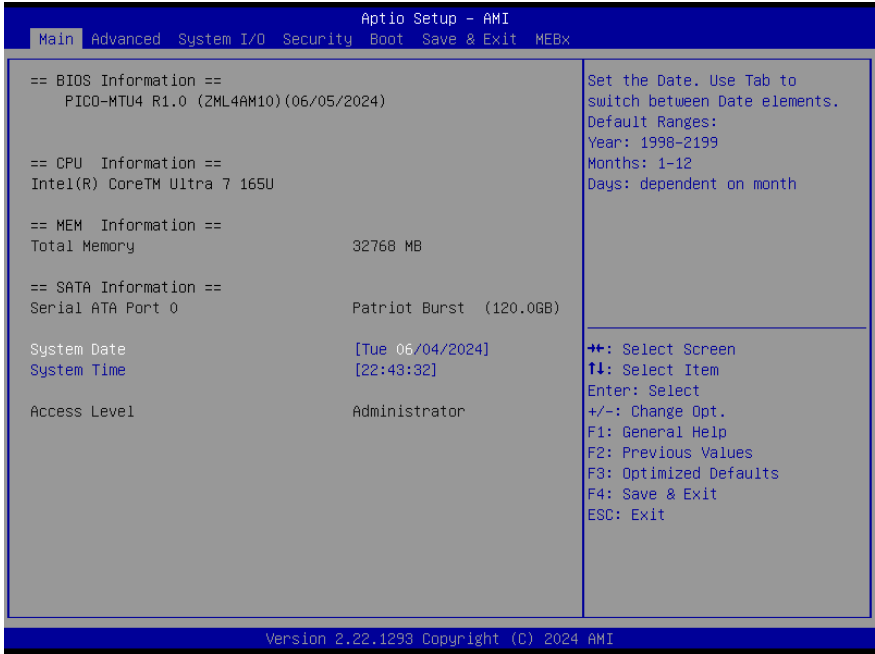

3.4 Setup Submenu: Advanced



3.4.1 CPU Configuration

Aptio Setup - AMI

Advanced

CPU Configuration		When enabled, a VMM can utilize the additional hardware capabilities provided by Vanderpool Technology.
Type	Intel(R) Core™ Ultra 7 165U	
ID	0xA06A4	+*: Select Screen ↑↓: Select Item Enter: Select +/-: Change Opt. F1: General Help F2: Previous Values F3: Optimized Defaults F4: Save & Exit ESC: Exit
Microcode Revision	1C	
Speed	1700 MHz	
VMX	Supported	
SMX/TXT	Supported	
Performance-core		
L1 Data Cache	48 KB x 2	
L1 Instruction Cache	64 KB x 2	
L2 Cache	2048 KB x 2	
L3 Cache	12 MB	
Efficient-core		
L1 Data Cache	32 KB x 10	
L1 Instruction Cache	64 KB x 10	
L2 Cache	2048 KB x 2	
L3 Cache	12 MB	
Intel (VMX) Virtualization Technology	[Enabled]	
Intel(R) SpeedStep(tm)	[Enabled]	
Turbo Mode	[Enabled]	
C states	[Enabled]	

Version 2.22.1293 Copyright (C) 2024 AMI

Options Summary		
Intel (VMX) Virtualization Technology	Disabled	
	Enabled	Optimal Default, Failsafe Default
When enabled, a VMM can utilize the additional hardware capabilities provided by Vanderpool Technology.		
Intel® SpeedStep™	Disabled	
	Enabled	Optimal Default, Failsafe Default
Allows more than two frequency ranges to be supported.		
Turbo Mode	Disabled	
	Enabled	Optimal Default, Failsafe Default
Enable or Disable processor Turbo Mode (requires EMTTM enable too). AUTO means enabled		
C states	Disabled	
	Enabled	Optimal Default, Failsafe Default
Enable/Disable CPU Power Management. Allows CPU to go to C states when it's not 100 utilized.		

3.4.2 Memory Configuration

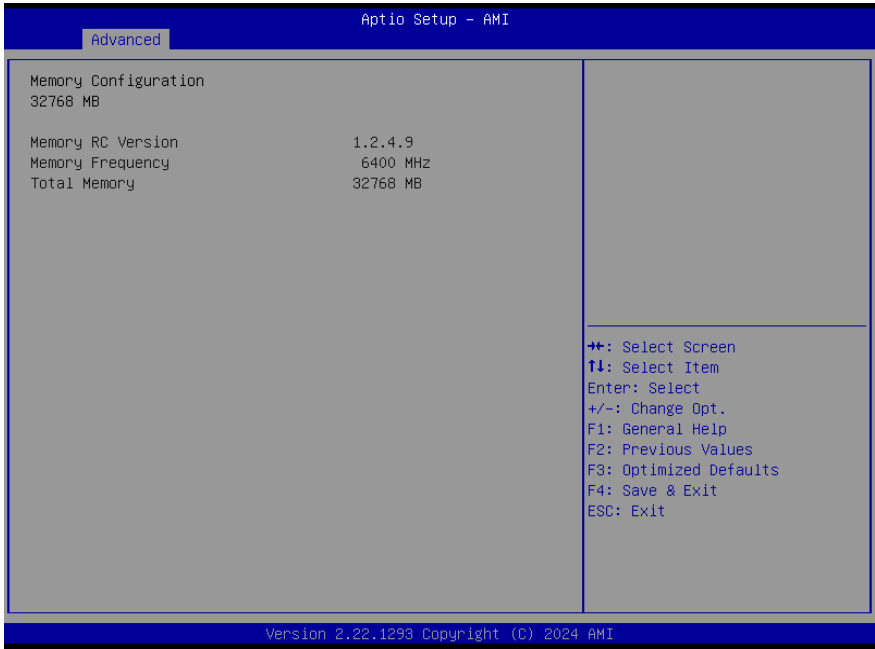

3.4.3 Hardware Monitor

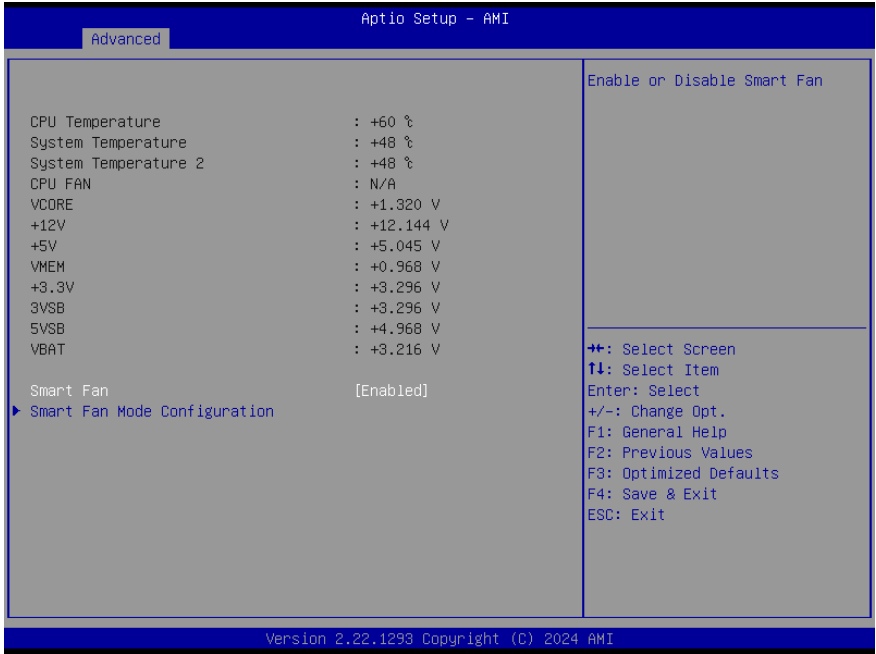

Options Summary		
Smart Fan	Disable	
	Enable	Optimal Default, Failsafe Default
Enables or Disables Smart Fan.		

3.4.3.1 Smart Fan Mode Configuration

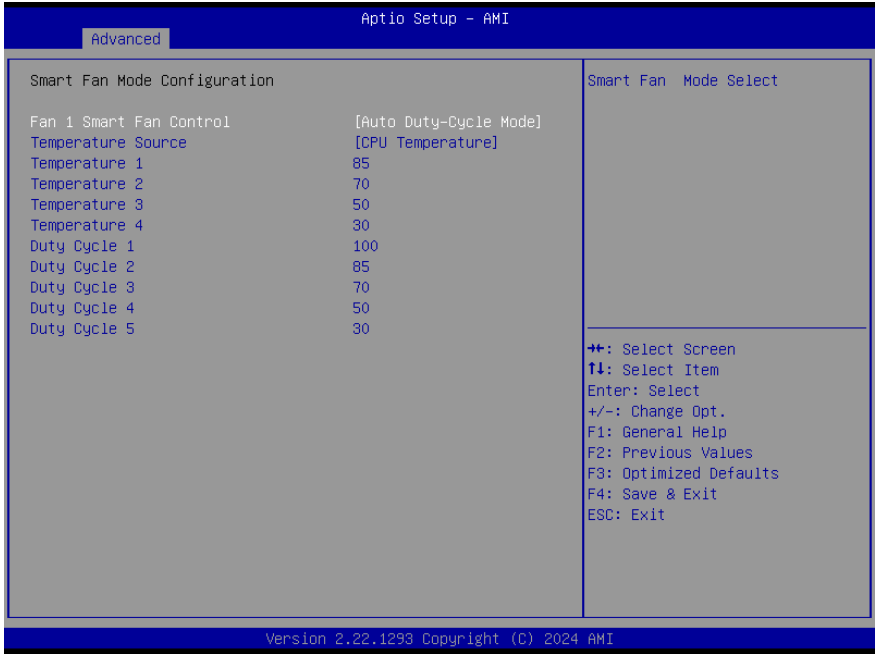

Options Summary		
Fan 1 Smart Fan Control	Manual Duty Mode	
	Auto Duty-Cycle Mode	Optimal Default, Failsafe Default
Smart Fan Mode Select		
Temperature Source	CPU Temperature	Optimal Default, Failsafe Default
	System Temperature	
	System Temperature 2	
Select the monitored temperature source for this fan.		
Temperature 1	86	
Duty Cycle 1	100	
Auto fan speed control. Fan speed will follow different temperature by different duty cycle 1-100		

3.4.4 PCH-FW Configuration

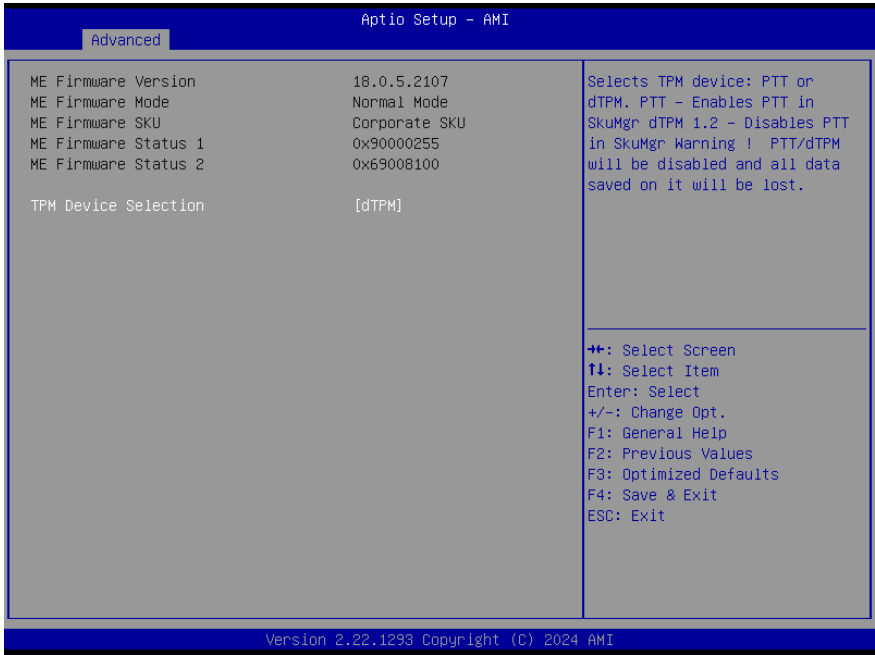

Options Summary		
TPM Device Selection	dTPM	Optimal Default, Failsafe Default
	PTT	
Selects TPM device: PTT or discrete TPM. PTT - enables PTT in SkuMgr dTPM - disables PTT is SkuMgr. Warning: PTT/dTPM will be disabled and all data saved on it will be lost.		

3.4.5 Power Management

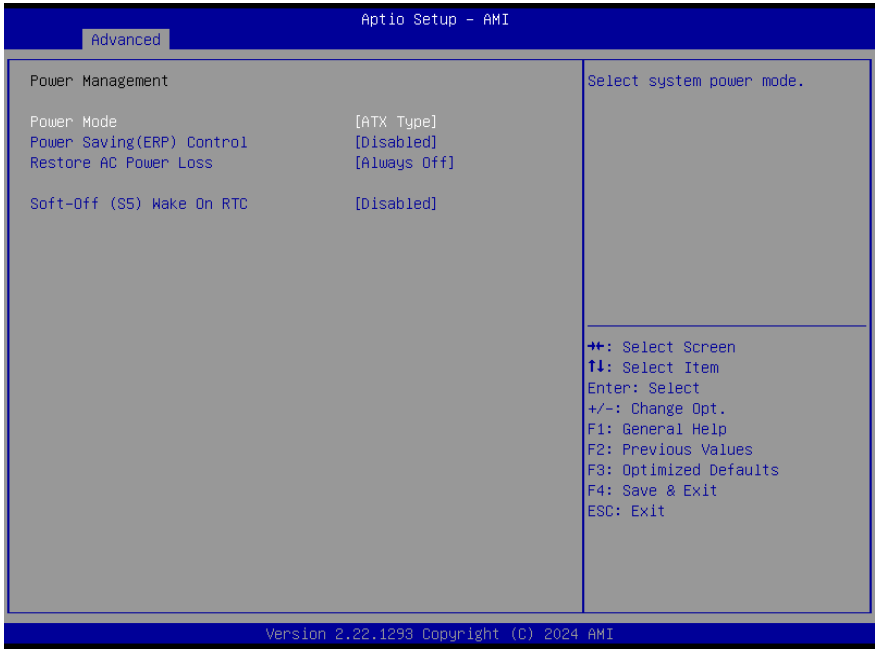

Options Summary		
Power Mode	ATX Type	Optimal Default, Failsafe Default
	AT Type	
Select power supply mode.		
Power Saving (ERP) Control	Disabled	Optimal Default, Failsafe Default
	Enabled	
Select Power saving control.		
Restore AC Power Loss	Last State	Optimal Default, Failsafe Default
	Always On	
	Always Off	
Select power state when power is re-applied after a power failure.		
Soft-Off (S5) Wake On RTC	Disable	Optimal Default, Failsafe Default
	By Date	
	By Weekday	
	Bypass	

Options Summary

By Date: System will wake on the with hr::min::sec specified./n By Weekday: System will wake on the enabled weekday with hr::min::sec specified./n Bypass: BIOS will not control RTC wake function.

3.4.6 AAEON BIOS Robot

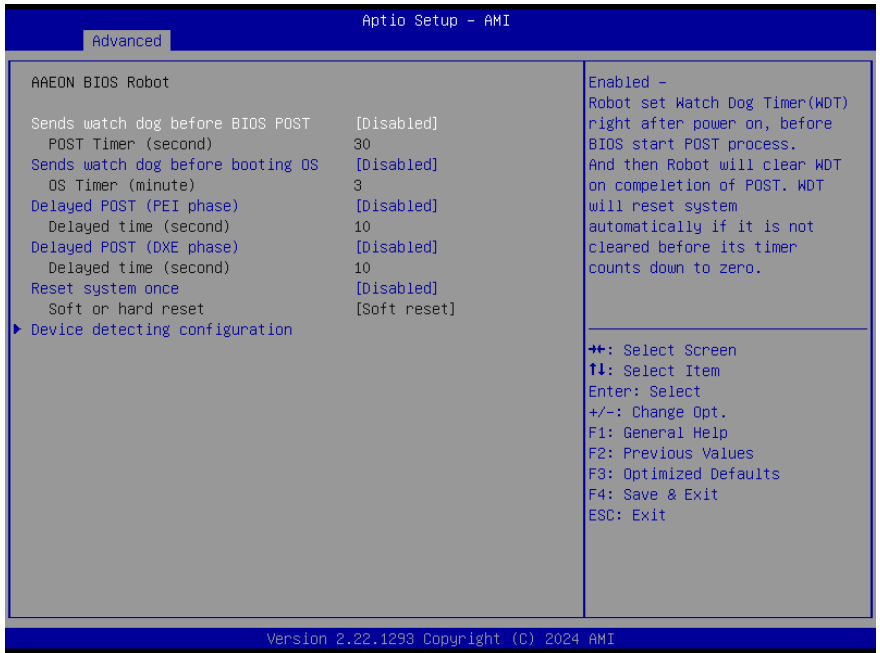

Options Summary

Sends watch dog before BIOS POST	Disabled	Optimal Default, Failsafe Default
	Enabled	
Enabled - Robot set Watch Dog Timer (WDT) right after power on, before BIOS start POST process. Then Robot will clear WDT on completion of POST. WDT will reset system automatically if it is not cleared before its timer counts down to zero.		
POST Timer (second)	30	Optimal Default, Failsafe Default

Options Summary		
Timer count set to Watch Dog Timer for POST. WARNING: Do not set to a value equal or shorter than normal POST time, otherwise system may never complete POST unless clearing BIOS settings. More than 2x normal POST time is suggested.		
Sends watch dog before booting OS	Disabled	Optimal Default, Failsafe Default
	Enabled	
Enabled - Robot set Watch Dog Timer (WDT) after POST completion, before BIOS transfer control to OS. WARNING: Before enabling this function, a program in OS must be in responsible for clearing WDT. Also, this function should be disabled if OS is going to update itself.		
OS Timer (minute)	3	Optimal Default, Failsafe Default
Timer count set to Watch Dog Timer for OS loading.		
Delayed POST (PEI phase)	Disabled	Optimal Default, Failsafe Default
	Enabled	
Enabled - Robot holds BIOS from starting POST, right after power on. This allows BIOS POST to start with stable power or start after system is physically warmed-up. Note: Robot does this before 'Sends watch dog'.		
Delayed time (second)	10	Optimal Default, Failsafe Default
Period of time for Robot to hold BIOS from POST.		
Delayed POST (DXE phase)	Disabled	Optimal Default, Failsafe Default
	Enabled	
Enabled - Robot holds BIOS before POST completion. This allows BIOS POST to start with stable power or start after system is physically warmed-up. Note: Robot does this after 'Sends watch dog before BIOS POST'.		
Delayed time (second)	10	Optimal Default, Failsafe Default
Period of time for Robot to hold BIOS from POST.		
Reset system once	Disabled	Optimal Default, Failsafe Default
	Enabled	
Enabled - Robot resets system for one time on each boot. This will send a soft or hard reset to onboard devices, thus puts devices to more stable state.		
Soft or hard reset	Soft reset	Optimal Default, Failsafe Default
	Hard reset"	
Select reset type robot should send on each boot.		

3.4.7 Device Detecting Configuration

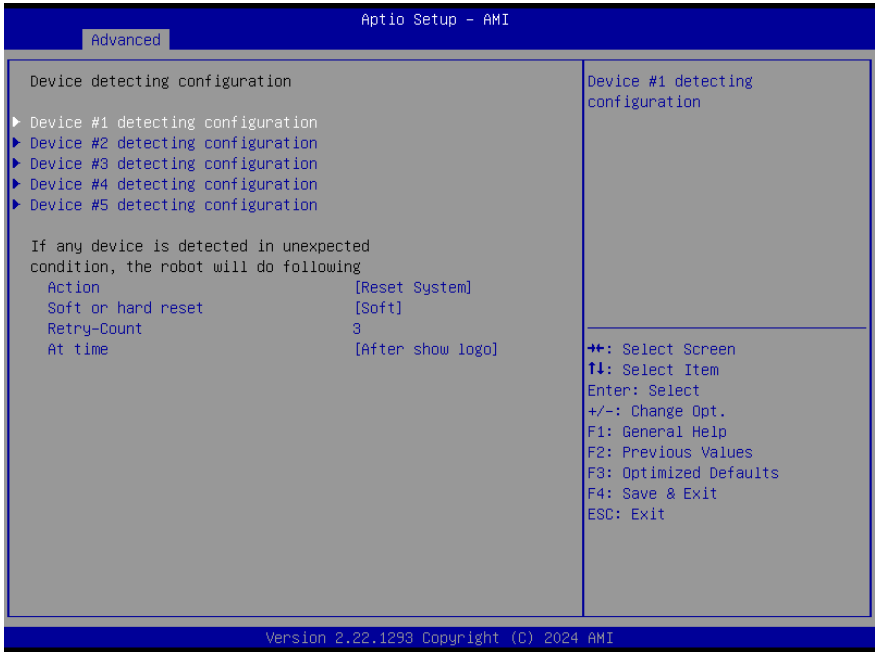

Options Summary		
Action	Reset System	Optimal Default, Failsafe Default
	Hold System	
Select action that robot should do.		
Soft or hard reset	Soft	Optimal Default, Failsafe Default
	Hard	
Select reset type robot should send on each boot.		
Retry-Count	30	Optimal Default, Failsafe Default
Fill retry counter here. Robot will reset system at most counter times, and then let system countinue its POST.		
At time	After show logo	Optimal Default, Failsafe Default
	Before show logo	

Options Summary

Select robot action time: After show logo - Robot will do action after logo is displayed. System devices are almost ready. Before show logo - Robot will do action earlier before logo, but some devices may not be ready.

3.4.7.1 Device #1 ~ #5 Detecting Configuration

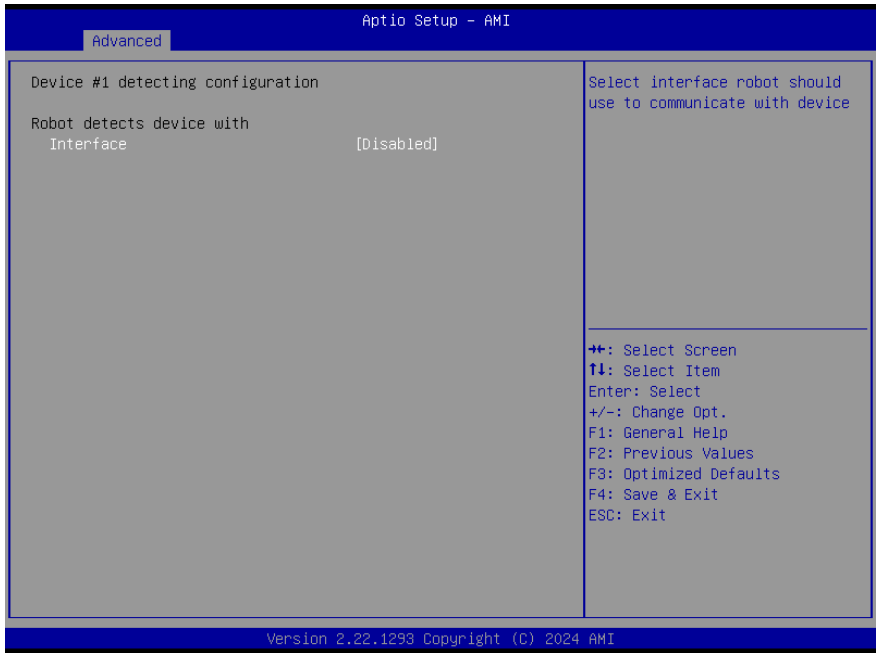

Options Summary

Interface	Disable	Optimal Default, Failsafe Default
	PCI	
	DIO	
	SMBUS	
	Legacy I/O	
	Super I/O	
	MMIO	

Select interface robot should use to communicate with device.

3.4.8 AAEON Smart Boost

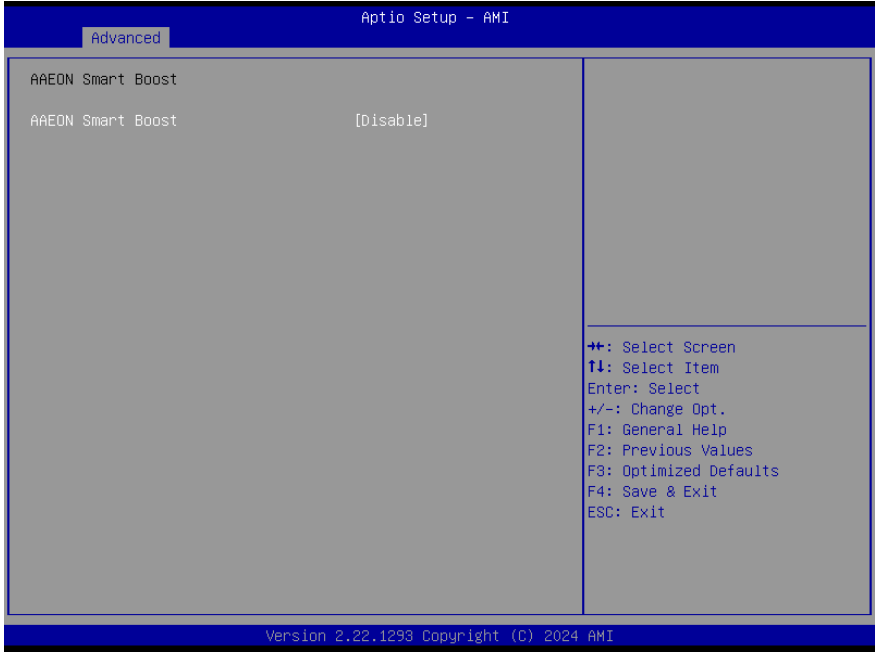

Options Summary		
AAEON Smart Boost	Disable	Optimal Default, Failsafe Default
	Smart Boost	
	Maximum Performance	
	Good Stability	

3.5 Setup Submenu: System I/O



3.5.1 Storage Configuration

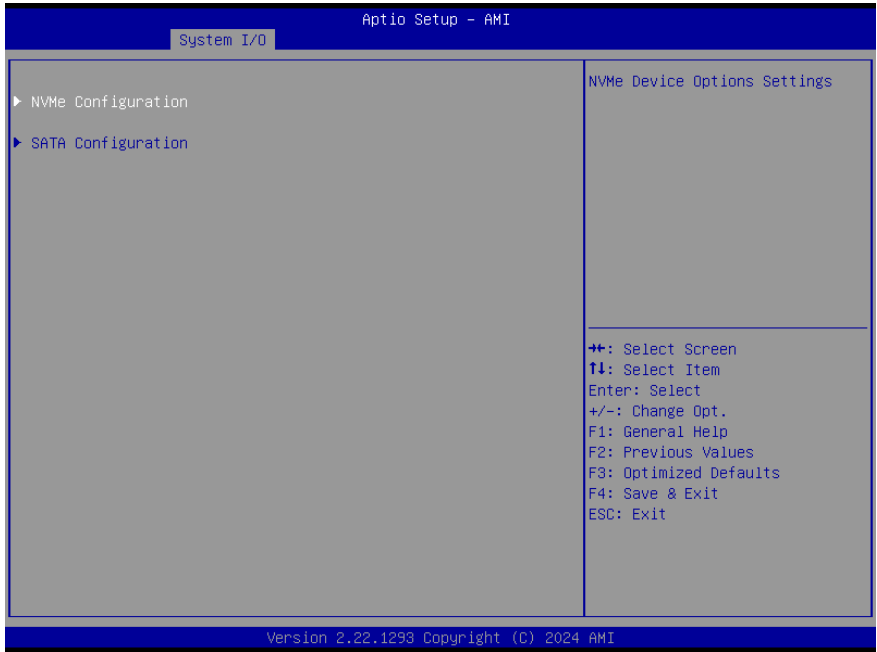

3.5.2 NVMe Configuration

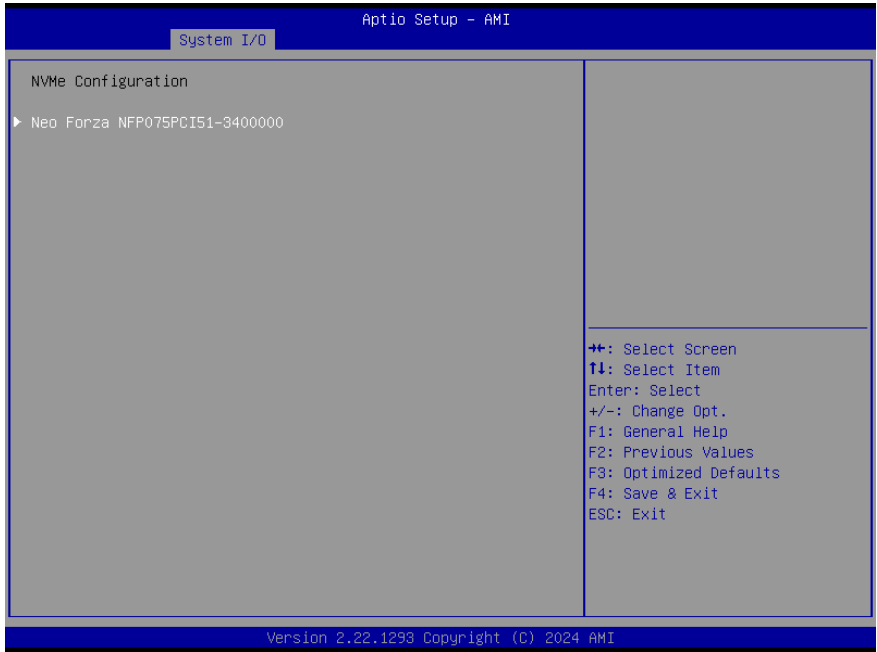

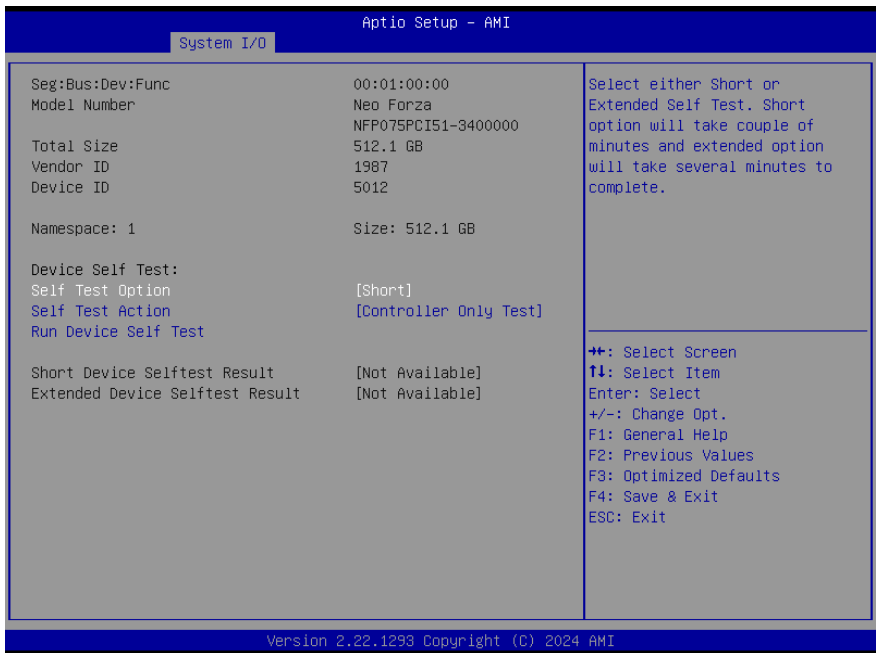

Options Summary

Self Test Option	Short	Optimal Default, Failsafe Default
	Extended	
Select either Short or Extended Self Test. Short option will take couple of minutes and extended option will take several minutes to complete.		
Self Test Action	Controller Only Test	Optimal Default, Failsafe Default
	Controller and NameSpace Test	
Select either to test Controller alone or Controller and NameSpace. Selecting Controller and NameSpace option will take lot longer to complete the test.		
Run Device Self Test	N/A	N/A
Perform device self test for the corresponding option and action selected by user. Pressing 'Esc' key will abort the test. Result shown below is the recent result logged in the device.		

3.5.3 SATA Configuration

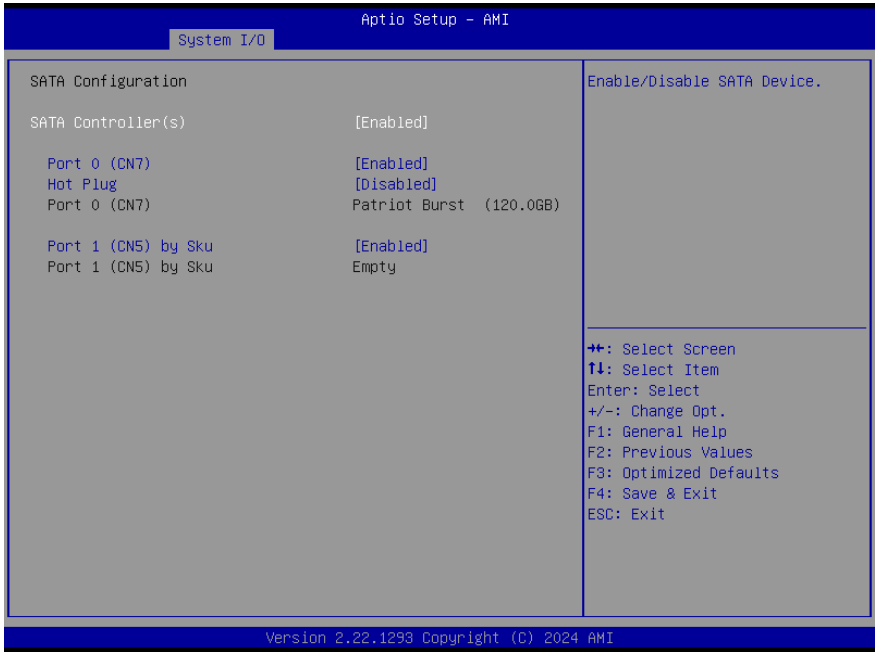

Options Summary		
SATA Controller(s)	Enabled	Optimal Default, Failsafe Default
	Disabled	
Enable/Disable SATA Device.		
Port 0 (CN10)	Enabled	Optimal Default, Failsafe Default
	Disabled	
Enable or Disable SATA Port.		
Port1(CN11)/mSATA (CN8)	Enabled	Optimal Default, Failsafe Default
	Disabled	
Enable or Disable SATA Port.		

3.5.4 GPIO Port Configuration

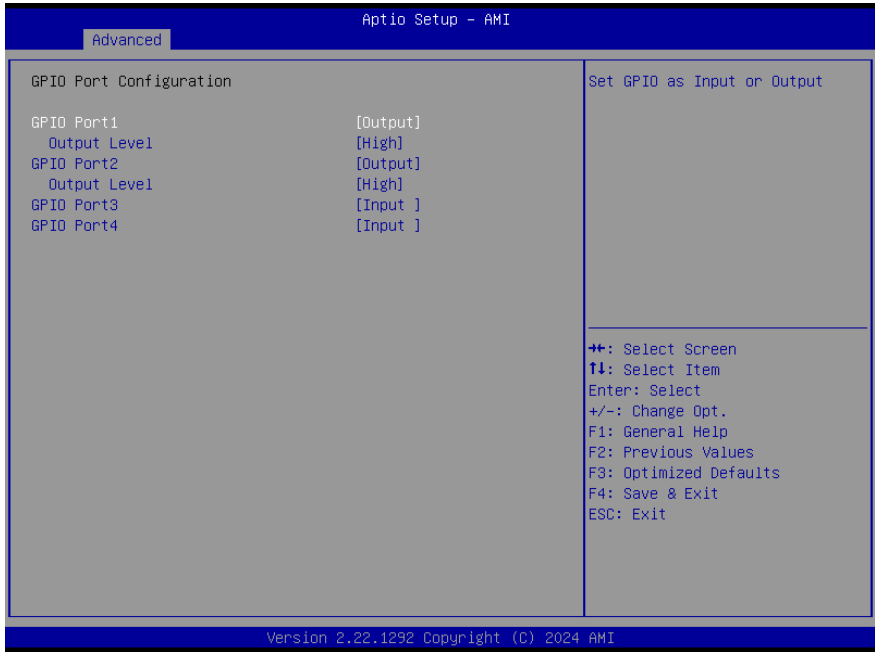

Options Summary		
GPIO Port*	Output	
	Input	
Set GPIO as Input or Output		
Output Level	High	
	Low	
Set output level when GPIO pin is output		

3.5.5 SIO Configuration



3.5.5.1 Serial Port 1 Configuration

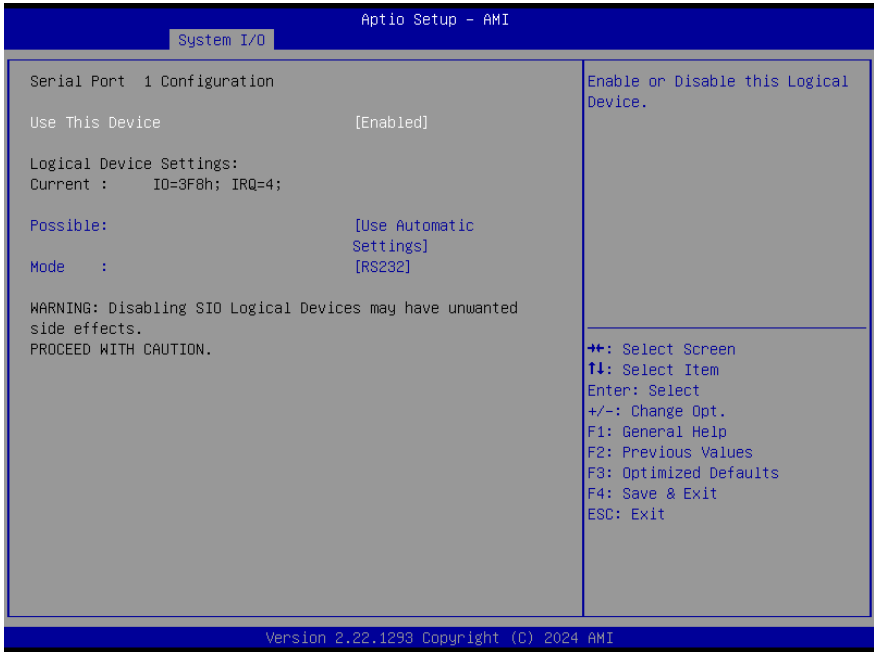

Options Summary		
Use This Device	Disable	
	Enable	Optimal Default, Failsafe Default
Enable or Disable this Logical Device.		
Possible:	Use Automatic Settings	Optimal Default, Failsafe Default
	IO=3F8h; IRQ=4	
	IO=2F8h; IRQ=3	
Allows user to change Device's Resource settings. New settings will be reflected on This Setup Page after System restarts.		
Mode:	RS232	Optimal Default, Failsafe Default
	RS422	
	RS485	
UART RS232, 422, 485 selection.		

3.5.5.2 Serial Port 2 Configuration

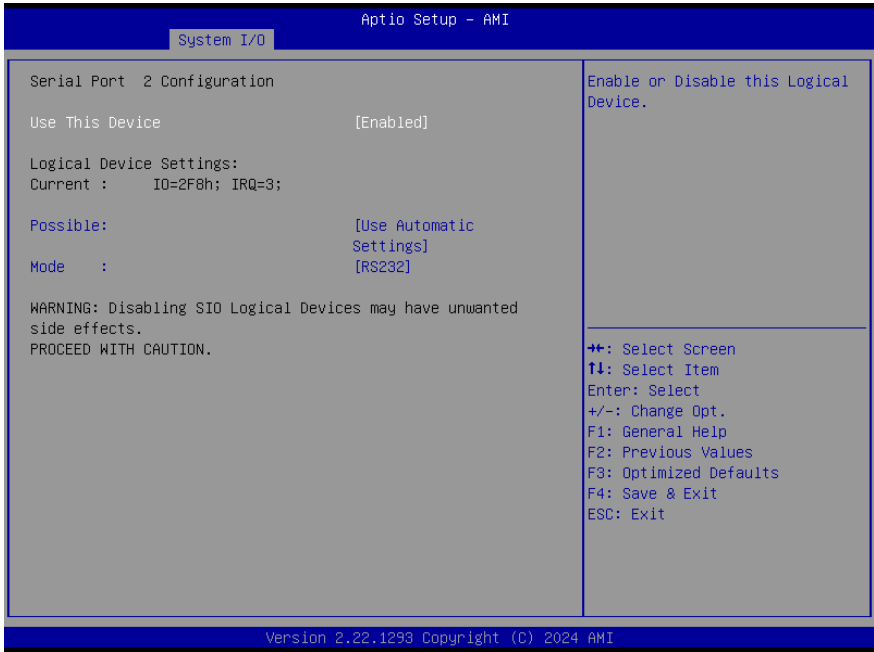

Options Summary		
Use This Device	Disable	
	Enable	Optimal Default, Failsafe Default
Enable or Disable this Logical Device.		
Possible:	Use Automatic Settings	Optimal Default, Failsafe Default
	IO=2F8h; IRQ=3	
	IO=3F8h; IRQ=4	
Allows user to change Device's Resource settings. New settings will be reflected on This Setup Page after System restarts.		
Mode:	RS232	Optimal Default, Failsafe Default
	RS422	
	RS485	
UART RS232, 422, 485 selection.		

3.5.6 Serial Port Console Redirection

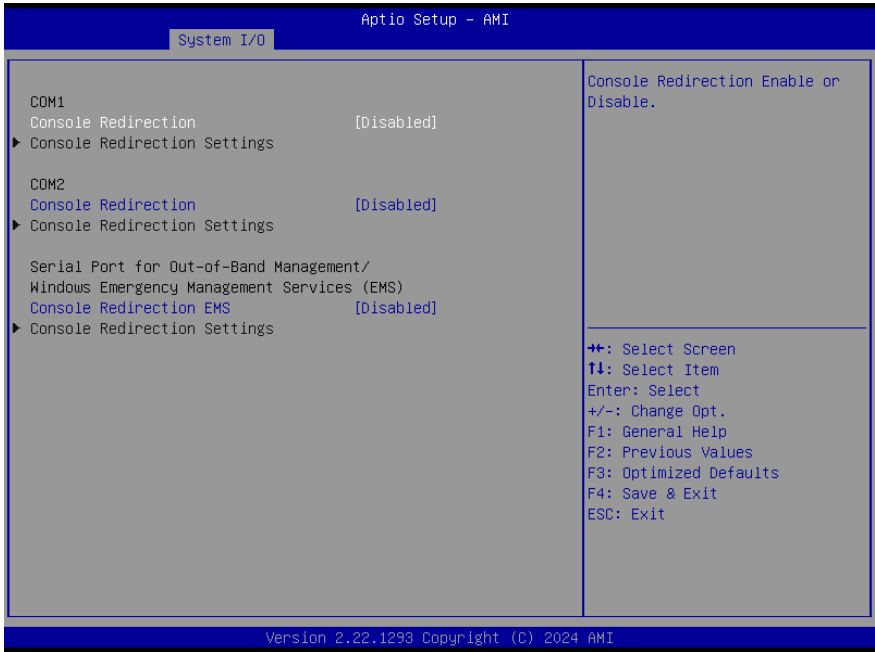

Options Summary		
Console Redirection	Disabled	Optimal Default, Failsafe Default
	Enabled	
Console Redirection Enable or Disable.		
Console Redirection EMS	Disabled	Optimal Default, Failsafe Default
	Enabled	
Console Redirection Enable or Disable.		

3.5.7 Serial IO Configuration

PICO-ITX Board

PICO-MTU4

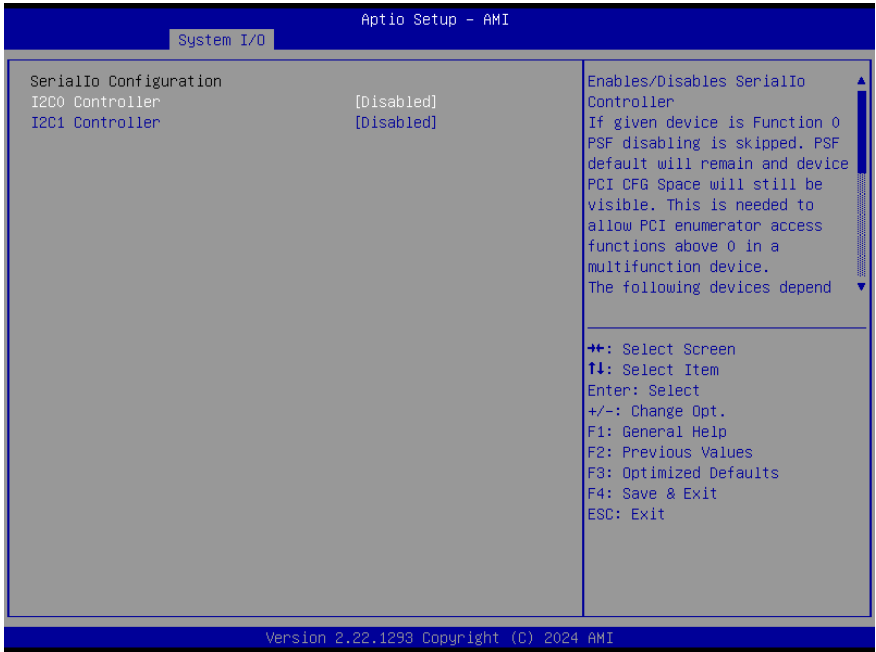

Options Summary		
I2C0 Controller	Disabled	Optimal Default, Failsafe Default
	Enabled	
Enable/Disable SerialIo Controller.		
I2C1 Controller	Disabled	Optimal Default, Failsafe Default
	Enabled	
Enable/Disable SerialIo Controller.		

3.6 Setup Submenu: Security

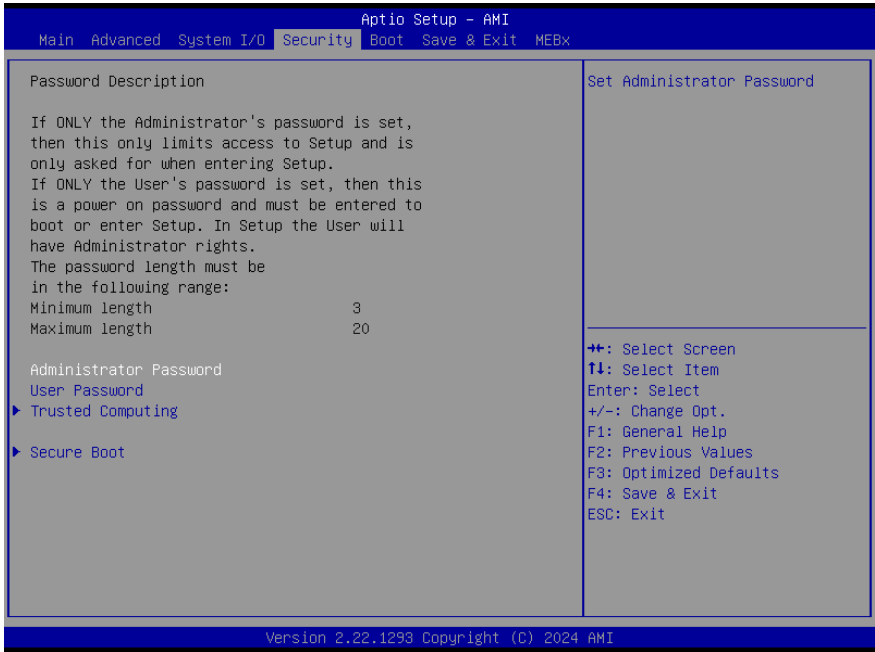

Change User/Supervisor Password

You can install a Supervisor password, and if you install a supervisor password, you can then install a user password. A user password does not provide access to many of the features in the Setup utility.

If you highlight these items and press Enter, a dialog box appears which lets you enter a password. You can enter no more than six letters or numbers. Press Enter after you have typed in the password. A second dialog box asks you to retype the password for confirmation. Press Enter after you have retyped it correctly. The password is required at boot time, or when the user enters the Setup utility.

Removing the Password

Highlight this item and type in the current password. At the next dialog box press Enter to disable password protection.

3.6.1 Trusted Computing

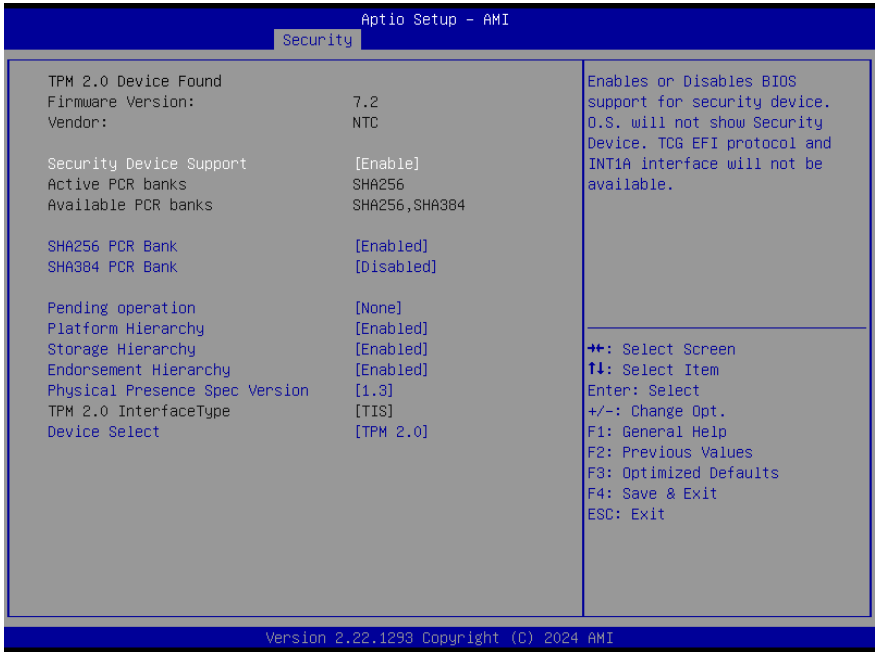

Options Summary		
Security Device Support	Enable	Optimal Default, Failsafe Default
	Disable	
Enables or Disables BIOS support for security device. O.S. will not show Security Device. TCG EFI protocol and INT1A interface will not be available.		
SHA256 PCR Bank	Enabled	Optimal Default, Failsafe Default
	Disabled	
Enable or Disable SHA256 PCR Bank.		
SHA384 PCR Bank	Enabled	Optimal Default, Failsafe Default
	Disabled	
Enable or Disable SHA384 PCR Bank.		
Pending operation	None	Optimal Default, Failsafe Default
	TPM Clear	
Schedule an Operation for the Security Device.		
NOTE: Your Computer will reboot during restart in order to change State of Security Device.		

Options Summary		
Platform Hierarchy	Enabled	Optimal Default, Failsafe Default
	Disabled	
Enable or Disable Platform Hierarchy		
Storage Hierarchy	Enabled	Optimal Default, Failsafe Default
	Disabled	
Enable or Disable Storage Hierarchy		
Endorsement Hierarchy	Enabled	Optimal Default, Failsafe Default
	Disabled	
Enable or Disable Endorsement Hierarchy		
Physical Presence Spec Version	1.3	Optimal Default, Failsafe Default
	1.2	
Select to Tell O.S. to support PPI Spec Version 1.2 or 1.3. Note some HCK tests might not support 1.3		
Device Select	Auto	
	TPM 1.2	
	TPM 2.0	Optimal Default, Failsafe Default
TPM 1.2 will restrict support to TPM 1.2 devices. TPM 2.0 will restrict support to TPM 2.0 devices. Auto will support both with the default set to TPM 2.0 devices if not found. TPM 1.2 devices will be enumerated.		

3.6.2 Secure Boot



Options Summary		
Secure Boot	Disabled	Optimal Default, Failsafe Default
	Enabled	
Secure Boot feature is Active if Secure Boot is Enabled, Platform Key (PK) is enrolled and the System is in User mode. The mode change requires platform reset		
Secure Boot Mode	Custom	Optimal Default, Failsafe Default
	Standard	
Secure Boot mode options: Standard or Custom. In Custom mode, Secure Boot Policy variables can be configured by a physically present user without full authentication		
Restore Factory Keys		
Force System to User Mode. Install factory default Secure Boot key databases		
Reset To Setup Mode		
Delete all Secure Boot key databases from NVRAM		

3.6.3 Expert Key Management

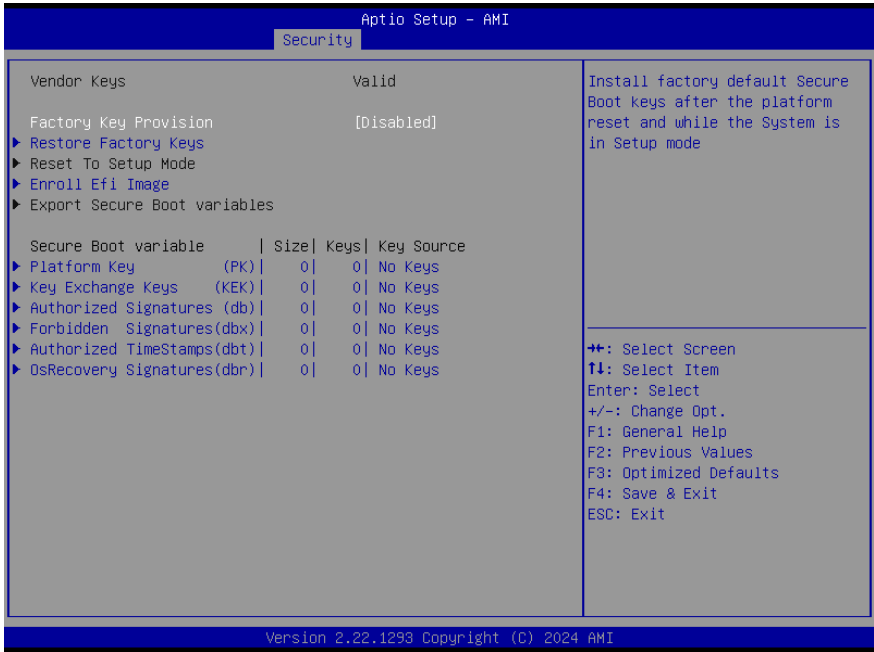

Options Summary		
Factory Key Provision	Disabled	Optimal Default, Failsafe Default
	Enabled	
Secure Boot feature is Active if Secure Boot is Enabled, Platform Key (PK) is enrolled and the System is in User mode. The mode change requires platform reset.		
Restore Factory Keys		
Force System to User Mode. Install factory default Secure Boot key databases.		
Reset To Setup Mode		
Delete all Secure Boot key databases from NVRAM.		
Export Secure Boot variables		
Copy NVRAM content of Secure Boot variables to files in a root folder on a file system device.		
Enroll Efi Image		
Allow the image to run in Secure Boot mode. Enroll SHA256 Hash certificate of a PE image into Authorized Signature Database (db).		
Remove 'UEFI CA' from DB		

Options Summary	
Device Guard ready system must not list 'Microsoft UEFI CA' Certificate in Authorized Signature database (db).	
Restore DB defaults	
Restore DB variable to factory defaults.	
Platform Key (PK)	Details
	Export
	Update
	Delete
Key Exchange Keys	Details
	Export
	Update
	Append
	Delete
Authorized Signatures	Details
	Export
	Update
	Append
	Delete
Forbidden Signatures	Details
	Export
	Update
	Append
	Delete
Authorized TimeStamps	Update
	Append
OsRecovery Signatures	Update
	Append
Enroll Factory Defaults or load certificates from a file: 1.Public Key Certificate: a) EFI_SIGNATURE_LIST b) EFI_CERT_X509 (DER) c) EFI_CERT_RSA2048 (bin) d) EFI_CERT_SHAXXX 2.Authenticated UEFI Variable 3.EFI PE/COFF Image (SHA256) Key Source: Factory, External, Mixed.	

3.7 Setup Submenu: Boot

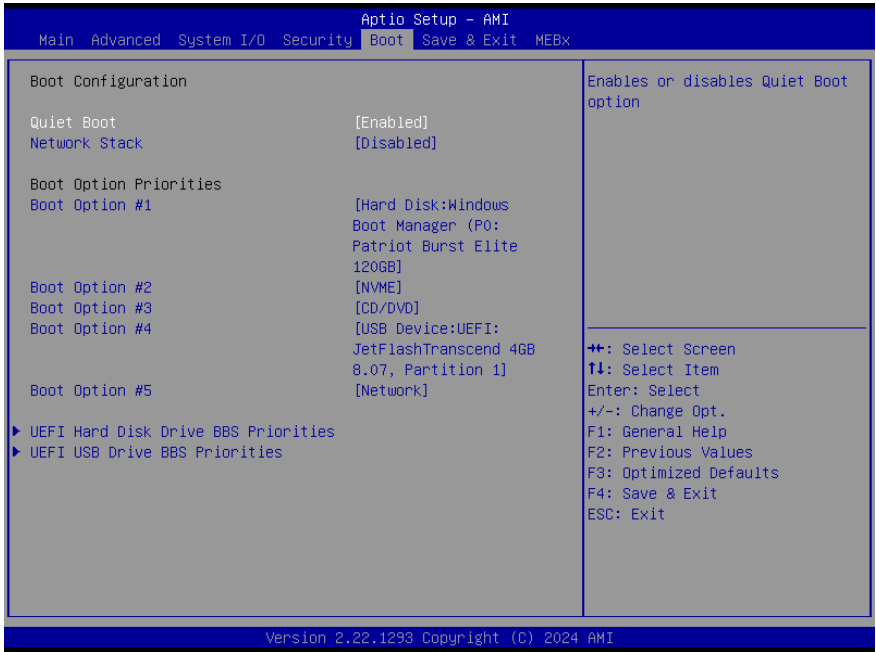

Options Summary		
Quiet Boot	Disabled	
	Enabled	Optimal Default, Failsafe Default
Enable or Disable Quiet Boot option.		
Network Stack	Disabled	Optimal Default, Failsafe Default
	Enabled	
Enable/Disable UEFI Network Stack.		
BOOT Option Priorities		
Sets the system boot order.		

3.7.1 BBS Priorities

Pico-ITX Board

PICO-MTU4





3.8 Setup Submenu: Save & Exit



Options Summary	
Save Changes and Reset	Reset the system after saving the changes.
Discard Changes and Exit	Exit system setup without saving any changes.
Restore Defaults	Restore/Load Default values for all the setup options.

3.9 Setup Submenu: MEBx

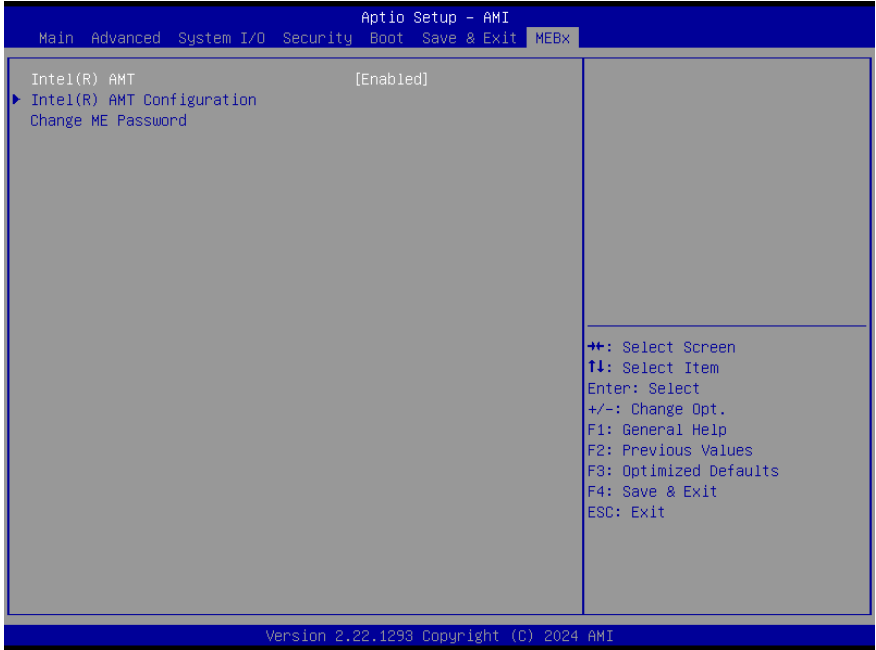

Options Summary		
Intel (R) AMT	Disabled	
	Enabled	Optimal Default, Failsafe Default
Enable or Disable Intel® AMT option.		
Change ME Password	Change Password for entering MEBx	

3.9.1 Intel® AMT Configuration

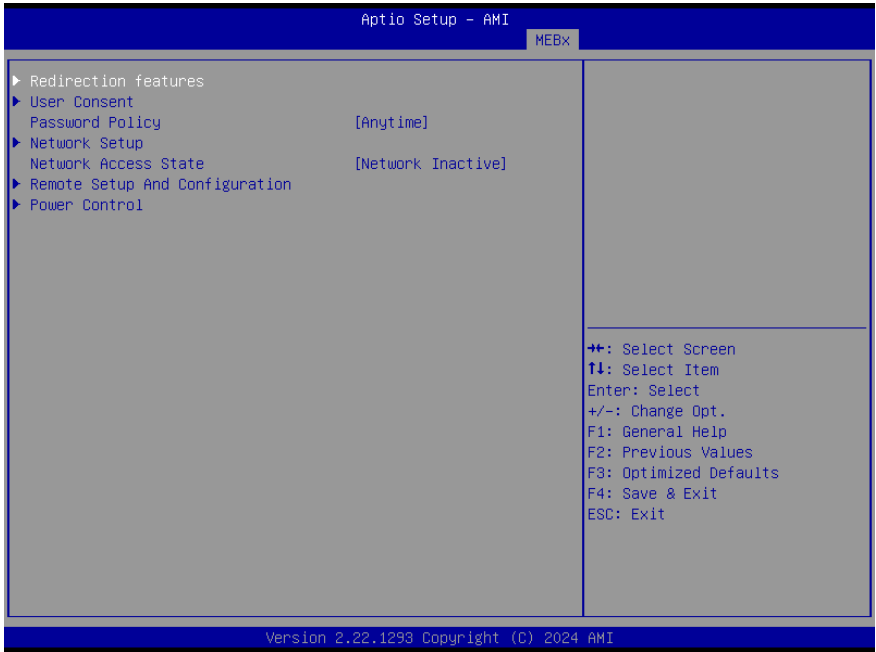

Options Summary		
Password Policy	Default Password Only	
	During Setup and Configuration	
	Anytime	Optimal Default, Failsafe Default
Network Access State	Network Active	
	Network Inactive	Optimal Default, Failsafe Default
	Full Unprovision	
Changes network state of ME. When disabling, it will also clear some other settings.		

3.9.2 Redirection Features

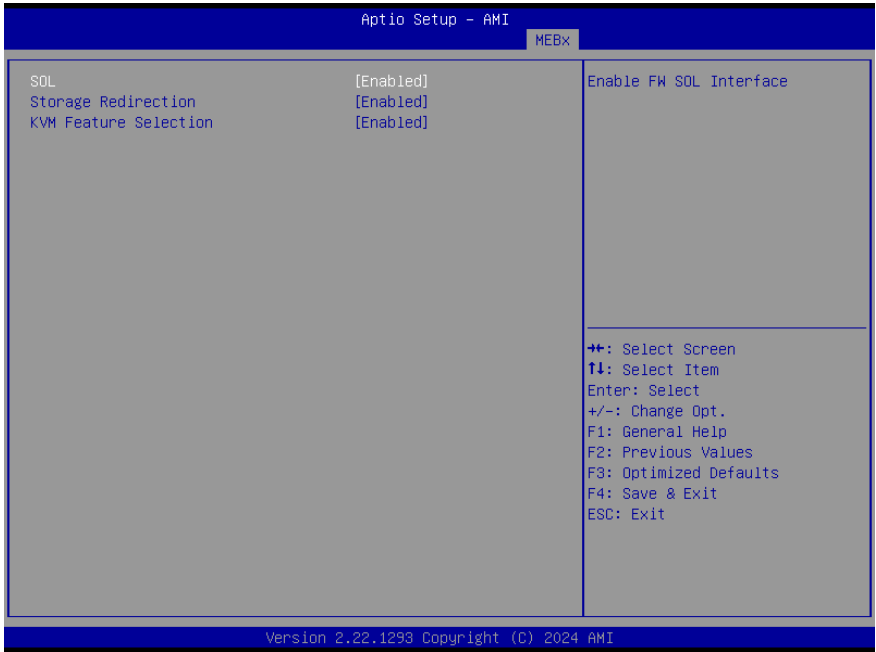

Options Summary		
SOL	Disabled	
	Enabled	Optimal Default, Failsafe Default
Enable FW SOL Interface.		
Storage Redirection	Disabled	
	Enabled	Optimal Default, Failsafe Default
Enable FW Remote – Storage Redirection.		
KVM Features Selection	Disabled	
	Enabled	Optimal Default, Failsafe Default
Enable FW KVM Feature.		

3.9.3 User Consent

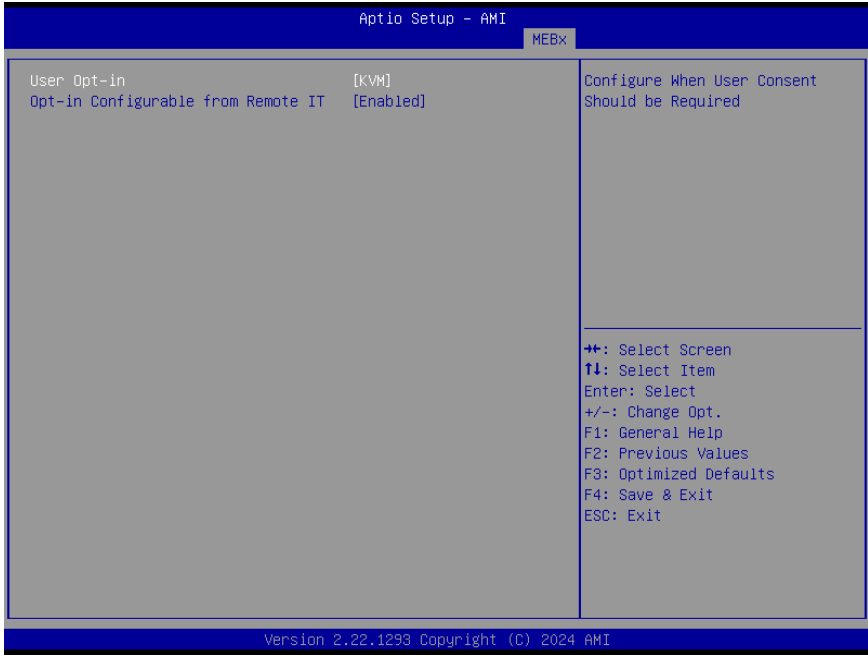

Options Summary		
User Opt-in	None	
	KVM	Optimal Default, Failsafe Default
	ALL	
Configure When User Consent Should be Required.		
Opt-in Configurable from Remote IT	Disabled	
	Enabled	Optimal Default, Failsafe Default
Enable/Disable Remote Change Capability of User Consent Feature.		

3.9.4 Network Setup

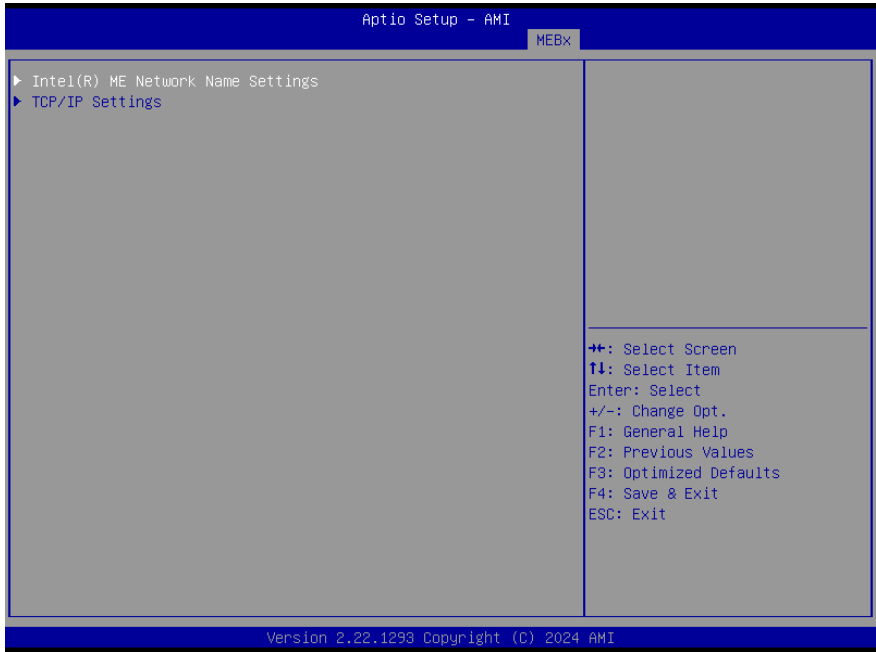

3.9.5 Intel® ME Network Name Settings



Options Summary		
FQDN		
Computer's FQDN		
Shared/Dedicated FQDN	Dedicated	
	Shared	Optimal Default, Failsafe Default

3.9.6 TCP/IP Settings



Options Summary		
DHCP Mode	Disabled	
	Enabled	Optimal Default, Failsafe Default
Enable/Disable IPV4 DHCP Mode.		

3.9.7 Remote Setup and Configuration

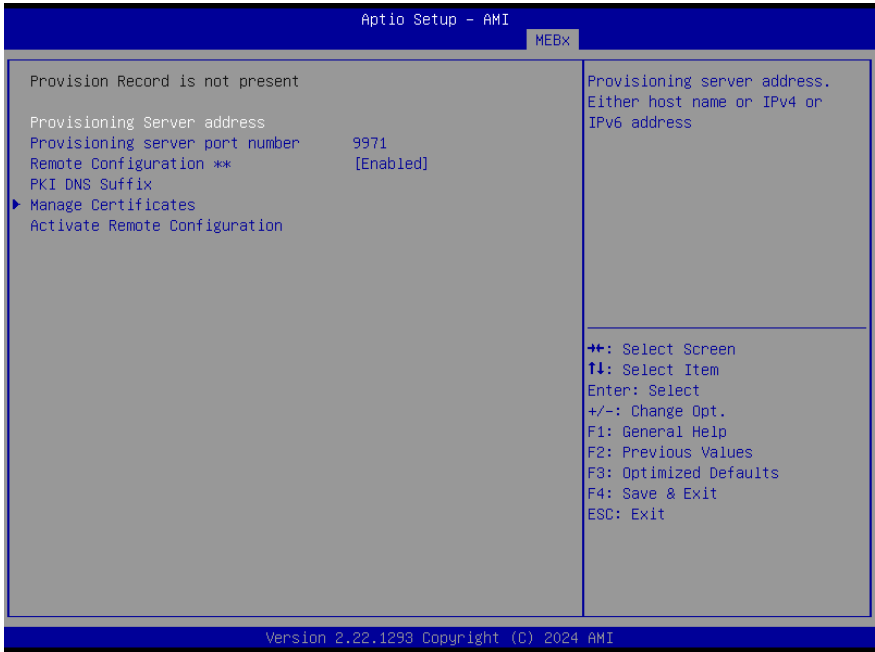

Options Summary		
Provisioning Server Address		
Provisioning server address. Either host name or IPv4 or IPv6 address.		
Provisioning Server Port number		
Provisioning server port number (0-65535)		
Remote Configuration **	Enabled	Optimal Default, Failsafe Default
	Disabled	

3.9.8 Power Control

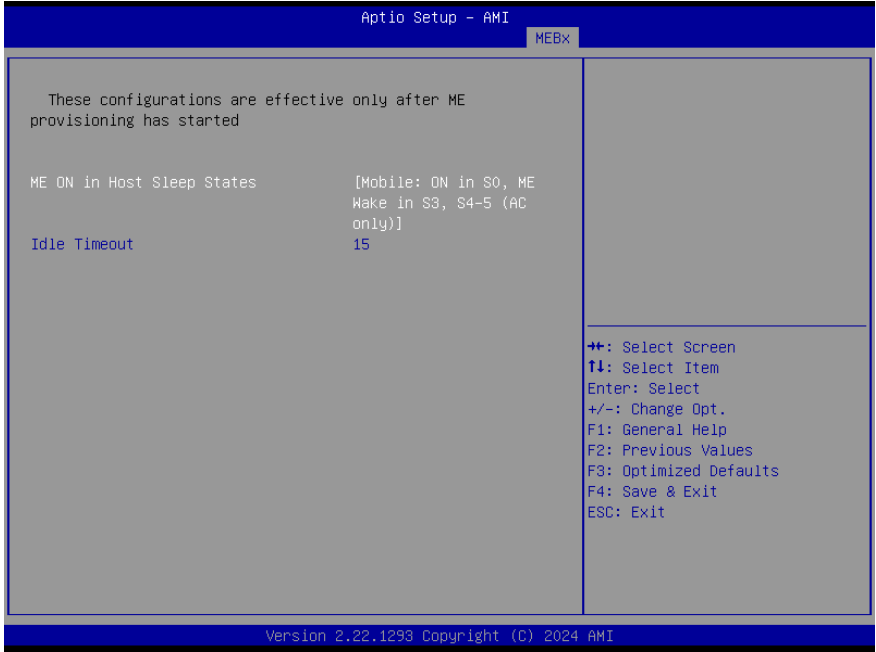

Options Summary		
ME ON in Host Sleep States	Mobile: ON in S0	
	Mobile: ON in S0, ME Wake in S3, S4-5 (AC only)	Optimal Default, Failsafe Default
Idle Timeout	15	Optimal Default, Failsafe Default
Timeout Value (1-65535)		

Chapter 4

Driver Installation

4.1 Driver Download/Installation

Drivers for the PICO-MTU4 can be downloaded from the product page on the AAEON website by following this link:

<https://www.aaeon.com/en/>

Download the driver(s) you need and follow the steps below to install them.

Chipset Driver

1. Open the folder where you unzipped the **Chipset Drivers**.
2. Run the **SetupChipset.exe** file in the folder.
3. Follow the instructions.
4. Drivers will be installed automatically.

Graphics Driver

1. Open the folder where you unzipped the **Graphics Drivers**.
2. Run the **Installer.exe** file in the folder.
3. Follow the instructions.
4. Drivers will be installed automatically.

LAN Drivers (Windows 10)

a) Install Intel I225/I226 Driver:

1. Open the folder where you unzipped the **LAN Drivers**.
2. Open the Device Manager by pressing Win + X and selecting "Device Manager."
3. Find the network adapter that corresponds to Intel I225/I226. It may be listed under "Network adapters."
4. Right-click on the network adapter and select "Update driver."
5. Choose "Browse my computer for drivers."
6. Navigate to the location where you extracted the driver files.
7. Follow the instructions.
8. Drivers will be installed automatically.

b) Install Intel I219 Driver:

1. Open the folder where you unzipped the **LAN Drivers**.
2. Open the Device Manager by pressing Win + X and selecting "Device Manager."
3. Find the network adapter that corresponds to Intel I219. It may be listed under "Network adapters."
4. Right-click on the network adapter and select "Update driver."
5. Choose "Browse my computer for drivers."
6. Navigate to the location where you extracted the driver files.
7. Follow the instructions.
8. Drivers will be installed automatically.

Intel Platform Monitoring Technology Driver

1. Open the folder where you unzipped the **Intel Platform Monitoring Technology Driver**.
2. Open the Device Manager by pressing Win + X and selecting "Device Manager."
3. Find the device that corresponds to Intel Platform Monitoring Technology. It may be listed under "System devices" or "Other devices."
4. Right-click on the device and select "Update driver."
5. Choose "Browse my computer for drivers."
6. Navigate to the location where you extracted the driver files.
7. Select the folder containing the files **intcpmt.cat**, **intcpmt.inf**, and **IntcPMT.sys**, then click "Next."
8. Follow the on-screen instructions to complete the driver installation.

ME & TXE Drivers (Windows 10)

1. Open the folder where you unzipped the **ME & TXE Drivers**.
2. Run the **SetupME.exe** file in the folder.
3. Follow the instructions.
4. Drivers will be installed automatically.

Intel NPU Driver

1. Open the Device Manager by pressing Win + X and selecting "Device Manager."
2. Find the device that corresponds to the Intel NPU. It may be listed under "Processors," "System devices," or "Other devices."
3. Right-click on the device and select "Update driver."
4. Choose "Browse my computer for drivers."
5. Navigate to the location where you extracted the driver files.
6. Select the folder containing all the extracted files and click "Next."
7. Follow the on-screen instructions to complete the driver installation.

Serial IO Driver

1. Open the folder where you unzipped the **Serial IO Driver**.
2. Run the **SetupSerialIO.exe** file in the folder.
3. Follow the instructions.
4. Drivers will be installed automatically.

Intel RST Driver

1. Open the folder where you unzipped the **Intel RST Driver**.
2. Run the **SetupRST.exe** file in the folder.
3. Follow the instructions.
4. Drivers will be installed automatically.

Appendix A

Mating Connectors

A.1 List of Mating Connectors and Cables

The following table lists mating connectors and available cables.

Connector Label	Function	Mating Connector		Cable P/N
		Vendor	Model no	
CN1	USB 2.0 Port	HIROSE	KW30-4P-1C(800)	170X000880
CN3	USB 2.0 Port	HIROSE	KW30-4P-1C(800)	170X000880
CN4	Front Panel	JST	SHR-10V-S-B	170X000603
CN6	COM Header	JST	SHDR-20V-S-B	170X000231
CN7	SATA Port	Molex	887505318	1709070500
CN10	SATA PWR	JST	PHR-2	1702150155
CN11	RTC Battery	Molex	51021-0200	175011301K
CN13	Power Input	Molex	19211-0003	170204010R
CN15	eDP	I-PEX	20453-030T-01S	N/A
CN16	IMVP9 Programming Port	JST	SHR-03V-S-B	N/A
CN17	I2C/SMBUS Header	JST	SHR-05V-S-B	170X000743
CN18	SPI Flash Programming Port	JST	SHR-07V-S-B	N/A
CN19	eSPI debug Header	JST	SHR-10V-S-B	1703100133
CN20	GPIO Port	JST	SHR-06V-S-B	N/A
CN21	4-pin Smart FAN	Molex	51021-0400	N/A

Appendix B

I/O Information

B.1 I/O Address Map

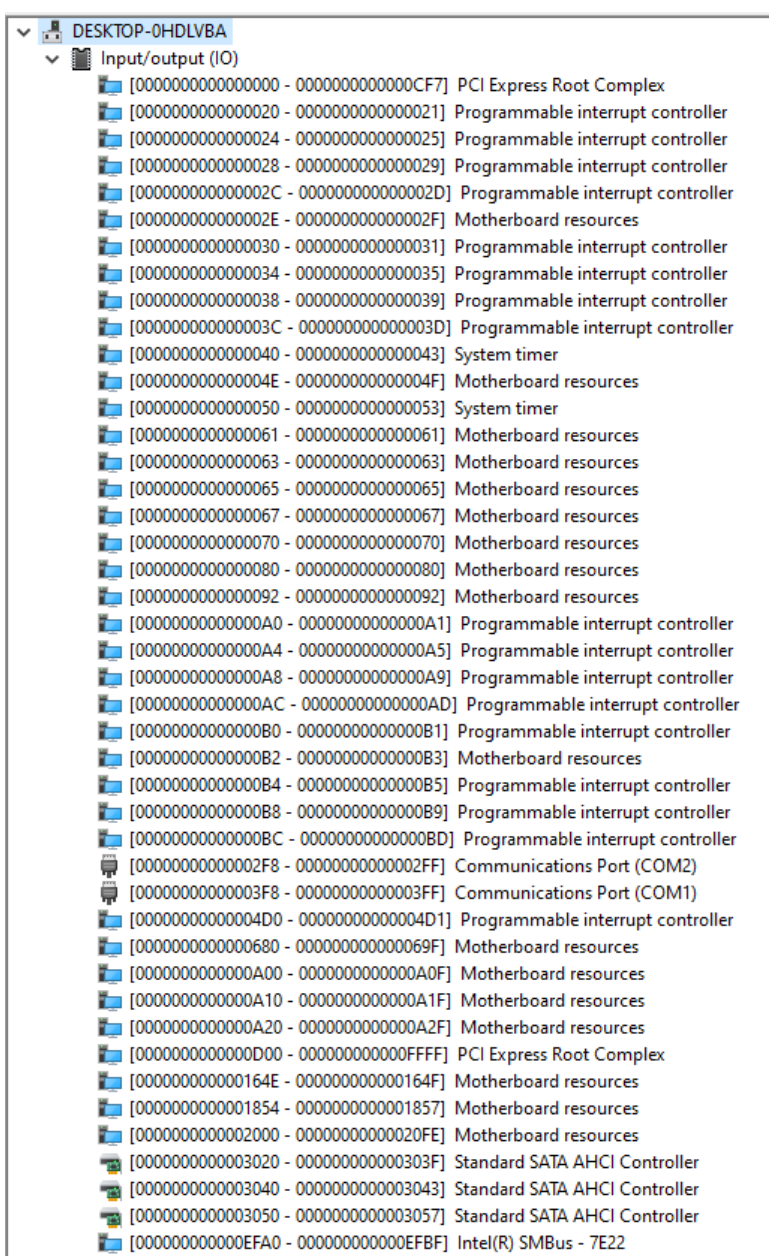









































































































The screenshot displays the Windows Device Manager window for a system named 'DESKTOP-0HDLVBA'. The 'Input/output (I/O)' category is expanded, showing a list of hardware devices with their corresponding I/O address ranges. The devices include various interrupt controllers, motherboard resources, system timers, communications ports, and storage controllers.















































Device Name	I/O Address Range
PCI Express Root Complex	[0000000000000000 - 0000000000000CF7]
Programmable interrupt controller	[0000000000000020 - 0000000000000021]
Programmable interrupt controller	[0000000000000024 - 0000000000000025]
Programmable interrupt controller	[0000000000000028 - 0000000000000029]
Programmable interrupt controller	[000000000000002C - 000000000000002D]
Motherboard resources	[000000000000002E - 000000000000002F]
Programmable interrupt controller	[0000000000000030 - 0000000000000031]
Programmable interrupt controller	[0000000000000034 - 0000000000000035]
Programmable interrupt controller	[0000000000000038 - 0000000000000039]
Programmable interrupt controller	[000000000000003C - 000000000000003D]
System timer	[0000000000000040 - 0000000000000043]
Motherboard resources	[000000000000004E - 000000000000004F]
System timer	[0000000000000050 - 0000000000000053]
Motherboard resources	[0000000000000061 - 0000000000000061]
Motherboard resources	[0000000000000063 - 0000000000000063]
Motherboard resources	[0000000000000065 - 0000000000000065]
Motherboard resources	[0000000000000067 - 0000000000000067]
Motherboard resources	[0000000000000070 - 0000000000000070]
Motherboard resources	[0000000000000080 - 0000000000000080]
Motherboard resources	[0000000000000092 - 0000000000000092]
Programmable interrupt controller	[00000000000000A0 - 00000000000000A1]
Programmable interrupt controller	[00000000000000A4 - 00000000000000A5]
Programmable interrupt controller	[00000000000000A8 - 00000000000000A9]
Programmable interrupt controller	[00000000000000AC - 00000000000000AD]
Programmable interrupt controller	[00000000000000B0 - 00000000000000B1]
Motherboard resources	[00000000000000B2 - 00000000000000B3]
Programmable interrupt controller	[00000000000000B4 - 00000000000000B5]
Programmable interrupt controller	[00000000000000B8 - 00000000000000B9]
Programmable interrupt controller	[00000000000000BC - 00000000000000BD]
Communications Port (COM2)	[00000000000002F8 - 00000000000002FF]
Communications Port (COM1)	[00000000000003F8 - 00000000000003FF]
Programmable interrupt controller	[00000000000004D0 - 00000000000004D1]
Motherboard resources	[0000000000000680 - 000000000000069F]
Motherboard resources	[0000000000000A00 - 0000000000000A0F]
Motherboard resources	[0000000000000A10 - 0000000000000A1F]
Motherboard resources	[0000000000000A20 - 0000000000000A2F]
PCI Express Root Complex	[0000000000000D00 - 0000000000000FFF]
Motherboard resources	[000000000000164E - 000000000000164F]
Motherboard resources	[0000000000001854 - 0000000000001857]
Motherboard resources	[0000000000002000 - 00000000000020FE]
Standard SATA AHCI Controller	[0000000000003020 - 000000000000303F]
Standard SATA AHCI Controller	[0000000000003040 - 0000000000003043]
Standard SATA AHCI Controller	[0000000000003050 - 0000000000003057]
Intel(R) SMBus - 7E22	[000000000000EFA0 - 000000000000EFBF]















































B.2 IRQ Mapping Chart















































IRQ	Device
(ISA) 0x00000000 (00)	System timer
(ISA) 0x00000003 (03)	Communications Port (COM2)
(ISA) 0x00000004 (04)	Communications Port (COM1)
(ISA) 0x0000000E (14)	Intel(R) Serial IO GPIO Host Controller - INTC1083
(ISA) 0x00000037 (55)	Microsoft ACPI-Compliant System
(ISA) 0x00000038 (56)	Microsoft ACPI-Compliant System
(ISA) 0x00000039 (57)	Microsoft ACPI-Compliant System
(ISA) 0x0000003A (58)	Microsoft ACPI-Compliant System
(ISA) 0x0000003B (59)	Microsoft ACPI-Compliant System
(ISA) 0x0000003C (60)	Microsoft ACPI-Compliant System
(ISA) 0x0000003D (61)	Microsoft ACPI-Compliant System
(ISA) 0x0000003E (62)	Microsoft ACPI-Compliant System
(ISA) 0x0000003F (63)	Microsoft ACPI-Compliant System
(ISA) 0x00000040 (64)	Microsoft ACPI-Compliant System
(ISA) 0x00000041 (65)	Microsoft ACPI-Compliant System
(ISA) 0x00000042 (66)	Microsoft ACPI-Compliant System
(ISA) 0x00000043 (67)	Microsoft ACPI-Compliant System
(ISA) 0x00000044 (68)	Microsoft ACPI-Compliant System
(ISA) 0x00000045 (69)	Microsoft ACPI-Compliant System
(ISA) 0x00000046 (70)	Microsoft ACPI-Compliant System
(ISA) 0x00000047 (71)	Microsoft ACPI-Compliant System
(ISA) 0x00000048 (72)	Microsoft ACPI-Compliant System
(ISA) 0x00000049 (73)	Microsoft ACPI-Compliant System
(ISA) 0x0000004A (74)	Microsoft ACPI-Compliant System
(ISA) 0x0000004B (75)	Microsoft ACPI-Compliant System
(ISA) 0x0000004C (76)	Microsoft ACPI-Compliant System
(ISA) 0x0000004D (77)	Microsoft ACPI-Compliant System
(ISA) 0x0000004E (78)	Microsoft ACPI-Compliant System
(ISA) 0x0000004F (79)	Microsoft ACPI-Compliant System
(ISA) 0x00000050 (80)	Microsoft ACPI-Compliant System
(ISA) 0x00000051 (81)	Microsoft ACPI-Compliant System
(ISA) 0x00000052 (82)	Microsoft ACPI-Compliant System
(ISA) 0x00000053 (83)	Microsoft ACPI-Compliant System
(ISA) 0x00000054 (84)	Microsoft ACPI-Compliant System
(ISA) 0x00000055 (85)	Microsoft ACPI-Compliant System
(ISA) 0x00000056 (86)	Microsoft ACPI-Compliant System
(ISA) 0x00000057 (87)	Microsoft ACPI-Compliant System
(ISA) 0x00000058 (88)	Microsoft ACPI-Compliant System
(ISA) 0x00000059 (89)	Microsoft ACPI-Compliant System
(ISA) 0x0000005A (90)	Microsoft ACPI-Compliant System
(ISA) 0x0000005B (91)	Microsoft ACPI-Compliant System
(ISA) 0x0000005C (92)	Microsoft ACPI-Compliant System
(ISA) 0x0000005D (93)	Microsoft ACPI-Compliant System
(ISA) 0x0000005E (94)	Microsoft ACPI-Compliant System
(ISA) 0x0000005F (95)	Microsoft ACPI-Compliant System
(ISA) 0x00000060 (96)	Microsoft ACPI-Compliant System
(ISA) 0x00000061 (97)	Microsoft ACPI-Compliant System
(ISA) 0x00000062 (98)	Microsoft ACPI-Compliant System
(ISA) 0x00000063 (99)	Microsoft ACPI-Compliant System













































 (ISA) 0x00000064 (100)	Microsoft ACPI-Compliant System
 (ISA) 0x00000065 (101)	Microsoft ACPI-Compliant System
 (ISA) 0x00000066 (102)	Microsoft ACPI-Compliant System
 (ISA) 0x00000067 (103)	Microsoft ACPI-Compliant System
 (ISA) 0x00000068 (104)	Microsoft ACPI-Compliant System
 (ISA) 0x00000069 (105)	Microsoft ACPI-Compliant System
 (ISA) 0x0000006A (106)	Microsoft ACPI-Compliant System
 (ISA) 0x0000006B (107)	Microsoft ACPI-Compliant System
 (ISA) 0x0000006C (108)	Microsoft ACPI-Compliant System
 (ISA) 0x0000006D (109)	Microsoft ACPI-Compliant System
 (ISA) 0x0000006E (110)	Microsoft ACPI-Compliant System
 (ISA) 0x0000006F (111)	Microsoft ACPI-Compliant System
 (ISA) 0x00000070 (112)	Microsoft ACPI-Compliant System
 (ISA) 0x00000071 (113)	Microsoft ACPI-Compliant System
 (ISA) 0x00000072 (114)	Microsoft ACPI-Compliant System
 (ISA) 0x00000073 (115)	Microsoft ACPI-Compliant System
 (ISA) 0x00000074 (116)	Microsoft ACPI-Compliant System
 (ISA) 0x00000075 (117)	Microsoft ACPI-Compliant System
 (ISA) 0x00000076 (118)	Microsoft ACPI-Compliant System
 (ISA) 0x00000077 (119)	Microsoft ACPI-Compliant System
 (ISA) 0x00000078 (120)	Microsoft ACPI-Compliant System
 (ISA) 0x00000079 (121)	Microsoft ACPI-Compliant System
 (ISA) 0x0000007A (122)	Microsoft ACPI-Compliant System
 (ISA) 0x0000007B (123)	Microsoft ACPI-Compliant System
 (ISA) 0x0000007C (124)	Microsoft ACPI-Compliant System
 (ISA) 0x0000007D (125)	Microsoft ACPI-Compliant System
 (ISA) 0x0000007E (126)	Microsoft ACPI-Compliant System
 (ISA) 0x0000007F (127)	Microsoft ACPI-Compliant System
 (ISA) 0x00000080 (128)	Microsoft ACPI-Compliant System
 (ISA) 0x00000081 (129)	Microsoft ACPI-Compliant System
 (ISA) 0x00000082 (130)	Microsoft ACPI-Compliant System
 (ISA) 0x00000083 (131)	Microsoft ACPI-Compliant System
 (ISA) 0x00000084 (132)	Microsoft ACPI-Compliant System
 (ISA) 0x00000085 (133)	Microsoft ACPI-Compliant System
 (ISA) 0x00000086 (134)	Microsoft ACPI-Compliant System
 (ISA) 0x00000087 (135)	Microsoft ACPI-Compliant System
 (ISA) 0x00000088 (136)	Microsoft ACPI-Compliant System
 (ISA) 0x00000089 (137)	Microsoft ACPI-Compliant System
 (ISA) 0x0000008A (138)	Microsoft ACPI-Compliant System
 (ISA) 0x0000008B (139)	Microsoft ACPI-Compliant System
 (ISA) 0x0000008C (140)	Microsoft ACPI-Compliant System
 (ISA) 0x0000008D (141)	Microsoft ACPI-Compliant System
 (ISA) 0x0000008E (142)	Microsoft ACPI-Compliant System
 (ISA) 0x0000008F (143)	Microsoft ACPI-Compliant System
 (ISA) 0x00000090 (144)	Microsoft ACPI-Compliant System
 (ISA) 0x00000091 (145)	Microsoft ACPI-Compliant System
 (ISA) 0x00000092 (146)	Microsoft ACPI-Compliant System
 (ISA) 0x00000093 (147)	Microsoft ACPI-Compliant System
 (ISA) 0x00000094 (148)	Microsoft ACPI-Compliant System
 (ISA) 0x00000095 (149)	Microsoft ACPI-Compliant System
 (ISA) 0x00000096 (150)	Microsoft ACPI-Compliant System
 (ISA) 0x00000097 (151)	Microsoft ACPI-Compliant System















































 (ISA) 0x0000098 (152)	Microsoft ACPI-Compliant System
 (ISA) 0x0000099 (153)	Microsoft ACPI-Compliant System
 (ISA) 0x000009A (154)	Microsoft ACPI-Compliant System
 (ISA) 0x000009B (155)	Microsoft ACPI-Compliant System
 (ISA) 0x000009C (156)	Microsoft ACPI-Compliant System
 (ISA) 0x000009D (157)	Microsoft ACPI-Compliant System
 (ISA) 0x000009E (158)	Microsoft ACPI-Compliant System
 (ISA) 0x000009F (159)	Microsoft ACPI-Compliant System
 (ISA) 0x00000A0 (160)	Microsoft ACPI-Compliant System
 (ISA) 0x00000A1 (161)	Microsoft ACPI-Compliant System
 (ISA) 0x00000A2 (162)	Microsoft ACPI-Compliant System
 (ISA) 0x00000A3 (163)	Microsoft ACPI-Compliant System
 (ISA) 0x00000A4 (164)	Microsoft ACPI-Compliant System
 (ISA) 0x00000A5 (165)	Microsoft ACPI-Compliant System
 (ISA) 0x00000A6 (166)	Microsoft ACPI-Compliant System
 (ISA) 0x00000A7 (167)	Microsoft ACPI-Compliant System
 (ISA) 0x00000A8 (168)	Microsoft ACPI-Compliant System
 (ISA) 0x00000A9 (169)	Microsoft ACPI-Compliant System
 (ISA) 0x00000AA (170)	Microsoft ACPI-Compliant System
 (ISA) 0x00000AB (171)	Microsoft ACPI-Compliant System
 (ISA) 0x00000AC (172)	Microsoft ACPI-Compliant System
 (ISA) 0x00000AD (173)	Microsoft ACPI-Compliant System
 (ISA) 0x00000AE (174)	Microsoft ACPI-Compliant System
 (ISA) 0x00000AF (175)	Microsoft ACPI-Compliant System
 (ISA) 0x00000B0 (176)	Microsoft ACPI-Compliant System
 (ISA) 0x00000B1 (177)	Microsoft ACPI-Compliant System
 (ISA) 0x00000B2 (178)	Microsoft ACPI-Compliant System
 (ISA) 0x00000B3 (179)	Microsoft ACPI-Compliant System
 (ISA) 0x00000B4 (180)	Microsoft ACPI-Compliant System
 (ISA) 0x00000B5 (181)	Microsoft ACPI-Compliant System
 (ISA) 0x00000B6 (182)	Microsoft ACPI-Compliant System
 (ISA) 0x00000B7 (183)	Microsoft ACPI-Compliant System
 (ISA) 0x00000B8 (184)	Microsoft ACPI-Compliant System
 (ISA) 0x00000B9 (185)	Microsoft ACPI-Compliant System
 (ISA) 0x00000BA (186)	Microsoft ACPI-Compliant System
 (ISA) 0x00000BB (187)	Microsoft ACPI-Compliant System
 (ISA) 0x00000BC (188)	Microsoft ACPI-Compliant System
 (ISA) 0x00000BD (189)	Microsoft ACPI-Compliant System
 (ISA) 0x00000BE (190)	Microsoft ACPI-Compliant System
 (ISA) 0x00000BF (191)	Microsoft ACPI-Compliant System
 (ISA) 0x00000C0 (192)	Microsoft ACPI-Compliant System
 (ISA) 0x00000C1 (193)	Microsoft ACPI-Compliant System
 (ISA) 0x00000C2 (194)	Microsoft ACPI-Compliant System
 (ISA) 0x00000C3 (195)	Microsoft ACPI-Compliant System
 (ISA) 0x00000C4 (196)	Microsoft ACPI-Compliant System
 (ISA) 0x00000C5 (197)	Microsoft ACPI-Compliant System
 (ISA) 0x00000C6 (198)	Microsoft ACPI-Compliant System
 (ISA) 0x00000C7 (199)	Microsoft ACPI-Compliant System
 (ISA) 0x00000C8 (200)	Microsoft ACPI-Compliant System
 (ISA) 0x00000C9 (201)	Microsoft ACPI-Compliant System
 (ISA) 0x00000CA (202)	Microsoft ACPI-Compliant System
 (ISA) 0x00000CB (203)	Microsoft ACPI-Compliant System



















 (ISA) 0x00000CC (204)	Microsoft ACPI-Compliant System
 (ISA) 0x00000100 (256)	Microsoft ACPI-Compliant System
 (ISA) 0x00000101 (257)	Microsoft ACPI-Compliant System
 (ISA) 0x00000102 (258)	Microsoft ACPI-Compliant System
 (ISA) 0x00000103 (259)	Microsoft ACPI-Compliant System
 (ISA) 0x00000104 (260)	Microsoft ACPI-Compliant System
 (ISA) 0x00000105 (261)	Microsoft ACPI-Compliant System
 (ISA) 0x00000106 (262)	Microsoft ACPI-Compliant System
 (ISA) 0x00000107 (263)	Microsoft ACPI-Compliant System
 (ISA) 0x00000108 (264)	Microsoft ACPI-Compliant System
 (ISA) 0x00000109 (265)	Microsoft ACPI-Compliant System
 (ISA) 0x0000010A (266)	Microsoft ACPI-Compliant System
 (ISA) 0x0000010B (267)	Microsoft ACPI-Compliant System
 (ISA) 0x0000010C (268)	Microsoft ACPI-Compliant System
 (ISA) 0x0000010D (269)	Microsoft ACPI-Compliant System
 (ISA) 0x0000010E (270)	Microsoft ACPI-Compliant System
 (ISA) 0x0000010F (271)	Microsoft ACPI-Compliant System
 (ISA) 0x00000110 (272)	Microsoft ACPI-Compliant System
 (ISA) 0x00000111 (273)	Microsoft ACPI-Compliant System
 (ISA) 0x00000112 (274)	Microsoft ACPI-Compliant System
 (ISA) 0x00000113 (275)	Microsoft ACPI-Compliant System
 (ISA) 0x00000114 (276)	Microsoft ACPI-Compliant System
 (ISA) 0x00000115 (277)	Microsoft ACPI-Compliant System
 (ISA) 0x00000116 (278)	Microsoft ACPI-Compliant System
 (ISA) 0x00000117 (279)	Microsoft ACPI-Compliant System
 (ISA) 0x00000118 (280)	Microsoft ACPI-Compliant System
 (ISA) 0x00000119 (281)	Microsoft ACPI-Compliant System
 (ISA) 0x0000011A (282)	Microsoft ACPI-Compliant System
 (ISA) 0x0000011B (283)	Microsoft ACPI-Compliant System
 (ISA) 0x0000011C (284)	Microsoft ACPI-Compliant System
 (ISA) 0x0000011D (285)	Microsoft ACPI-Compliant System
 (ISA) 0x0000011E (286)	Microsoft ACPI-Compliant System
 (ISA) 0x0000011F (287)	Microsoft ACPI-Compliant System
 (ISA) 0x00000120 (288)	Microsoft ACPI-Compliant System
 (ISA) 0x00000121 (289)	Microsoft ACPI-Compliant System
 (ISA) 0x00000122 (290)	Microsoft ACPI-Compliant System
 (ISA) 0x00000123 (291)	Microsoft ACPI-Compliant System
 (ISA) 0x00000124 (292)	Microsoft ACPI-Compliant System
 (ISA) 0x00000125 (293)	Microsoft ACPI-Compliant System
 (ISA) 0x00000126 (294)	Microsoft ACPI-Compliant System
 (ISA) 0x00000127 (295)	Microsoft ACPI-Compliant System
 (ISA) 0x00000128 (296)	Microsoft ACPI-Compliant System
 (ISA) 0x00000129 (297)	Microsoft ACPI-Compliant System
 (ISA) 0x0000012A (298)	Microsoft ACPI-Compliant System
 (ISA) 0x0000012B (299)	Microsoft ACPI-Compliant System
 (ISA) 0x0000012C (300)	Microsoft ACPI-Compliant System
 (ISA) 0x0000012D (301)	Microsoft ACPI-Compliant System
(ISA) 0x0000012E (302)	Microsoft ACPI-Compliant System
(ISA) 0x0000012F (303)	Microsoft ACPI-Compliant System
(ISA) 0x00000130 (304)	Microsoft ACPI-Compliant System
(ISA) 0x00000131 (305)	Microsoft ACPI-Compliant System
(ISA) 0x00000132 (306)	Microsoft ACPI-Compliant System

 (ISA) 0x00000133 (307)	Microsoft ACPI-Compliant System
 (ISA) 0x00000134 (308)	Microsoft ACPI-Compliant System
 (ISA) 0x00000135 (309)	Microsoft ACPI-Compliant System
 (ISA) 0x00000136 (310)	Microsoft ACPI-Compliant System
 (ISA) 0x00000137 (311)	Microsoft ACPI-Compliant System
 (ISA) 0x00000138 (312)	Microsoft ACPI-Compliant System
 (ISA) 0x00000139 (313)	Microsoft ACPI-Compliant System
 (ISA) 0x0000013A (314)	Microsoft ACPI-Compliant System
 (ISA) 0x0000013B (315)	Microsoft ACPI-Compliant System
 (ISA) 0x0000013C (316)	Microsoft ACPI-Compliant System
 (ISA) 0x0000013D (317)	Microsoft ACPI-Compliant System
 (ISA) 0x0000013E (318)	Microsoft ACPI-Compliant System
 (ISA) 0x0000013F (319)	Microsoft ACPI-Compliant System
 (ISA) 0x00000140 (320)	Microsoft ACPI-Compliant System
 (ISA) 0x00000141 (321)	Microsoft ACPI-Compliant System
 (ISA) 0x00000142 (322)	Microsoft ACPI-Compliant System
 (ISA) 0x00000143 (323)	Microsoft ACPI-Compliant System
 (ISA) 0x00000144 (324)	Microsoft ACPI-Compliant System
 (ISA) 0x00000145 (325)	Microsoft ACPI-Compliant System
 (ISA) 0x00000146 (326)	Microsoft ACPI-Compliant System
 (ISA) 0x00000147 (327)	Microsoft ACPI-Compliant System
 (ISA) 0x00000148 (328)	Microsoft ACPI-Compliant System
 (ISA) 0x00000149 (329)	Microsoft ACPI-Compliant System
 (ISA) 0x0000014A (330)	Microsoft ACPI-Compliant System
 (ISA) 0x0000014B (331)	Microsoft ACPI-Compliant System
 (ISA) 0x0000014C (332)	Microsoft ACPI-Compliant System
 (ISA) 0x0000014D (333)	Microsoft ACPI-Compliant System
 (ISA) 0x0000014E (334)	Microsoft ACPI-Compliant System
 (ISA) 0x0000014F (335)	Microsoft ACPI-Compliant System
 (ISA) 0x00000150 (336)	Microsoft ACPI-Compliant System
 (ISA) 0x00000151 (337)	Microsoft ACPI-Compliant System
 (ISA) 0x00000152 (338)	Microsoft ACPI-Compliant System
 (ISA) 0x00000153 (339)	Microsoft ACPI-Compliant System
 (ISA) 0x00000154 (340)	Microsoft ACPI-Compliant System
 (ISA) 0x00000155 (341)	Microsoft ACPI-Compliant System
 (ISA) 0x00000156 (342)	Microsoft ACPI-Compliant System
 (ISA) 0x00000157 (343)	Microsoft ACPI-Compliant System
 (ISA) 0x00000158 (344)	Microsoft ACPI-Compliant System
 (ISA) 0x00000159 (345)	Microsoft ACPI-Compliant System
 (ISA) 0x0000015A (346)	Microsoft ACPI-Compliant System
 (ISA) 0x0000015B (347)	Microsoft ACPI-Compliant System
 (ISA) 0x0000015C (348)	Microsoft ACPI-Compliant System
 (ISA) 0x0000015D (349)	Microsoft ACPI-Compliant System
 (ISA) 0x0000015E (350)	Microsoft ACPI-Compliant System
 (ISA) 0x0000015F (351)	Microsoft ACPI-Compliant System
 (ISA) 0x00000160 (352)	Microsoft ACPI-Compliant System
 (ISA) 0x00000161 (353)	Microsoft ACPI-Compliant System
(ISA) 0x00000162 (354)	Microsoft ACPI-Compliant System
(ISA) 0x00000163 (355)	Microsoft ACPI-Compliant System
(ISA) 0x00000164 (356)	Microsoft ACPI-Compliant System
(ISA) 0x00000165 (357)	Microsoft ACPI-Compliant System
(ISA) 0x00000166 (358)	Microsoft ACPI-Compliant System

 (ISA) 0x00000167 (359)	Microsoft ACPI-Compliant System
 (ISA) 0x00000168 (360)	Microsoft ACPI-Compliant System
 (ISA) 0x00000169 (361)	Microsoft ACPI-Compliant System
 (ISA) 0x0000016A (362)	Microsoft ACPI-Compliant System
 (ISA) 0x0000016B (363)	Microsoft ACPI-Compliant System
 (ISA) 0x0000016C (364)	Microsoft ACPI-Compliant System
 (ISA) 0x0000016D (365)	Microsoft ACPI-Compliant System
 (ISA) 0x0000016E (366)	Microsoft ACPI-Compliant System
 (ISA) 0x0000016F (367)	Microsoft ACPI-Compliant System
 (ISA) 0x00000170 (368)	Microsoft ACPI-Compliant System
 (ISA) 0x00000171 (369)	Microsoft ACPI-Compliant System
 (ISA) 0x00000172 (370)	Microsoft ACPI-Compliant System
 (ISA) 0x00000173 (371)	Microsoft ACPI-Compliant System
 (ISA) 0x00000174 (372)	Microsoft ACPI-Compliant System
 (ISA) 0x00000175 (373)	Microsoft ACPI-Compliant System
 (ISA) 0x00000176 (374)	Microsoft ACPI-Compliant System
 (ISA) 0x00000177 (375)	Microsoft ACPI-Compliant System
 (ISA) 0x00000178 (376)	Microsoft ACPI-Compliant System
 (ISA) 0x00000179 (377)	Microsoft ACPI-Compliant System
 (ISA) 0x0000017A (378)	Microsoft ACPI-Compliant System
 (ISA) 0x0000017B (379)	Microsoft ACPI-Compliant System
 (ISA) 0x0000017C (380)	Microsoft ACPI-Compliant System
 (ISA) 0x0000017D (381)	Microsoft ACPI-Compliant System
 (ISA) 0x0000017E (382)	Microsoft ACPI-Compliant System
 (ISA) 0x0000017F (383)	Microsoft ACPI-Compliant System
 (ISA) 0x00000180 (384)	Microsoft ACPI-Compliant System
 (ISA) 0x00000181 (385)	Microsoft ACPI-Compliant System
 (ISA) 0x00000182 (386)	Microsoft ACPI-Compliant System
 (ISA) 0x00000183 (387)	Microsoft ACPI-Compliant System
 (ISA) 0x00000184 (388)	Microsoft ACPI-Compliant System
 (ISA) 0x00000185 (389)	Microsoft ACPI-Compliant System
 (ISA) 0x00000186 (390)	Microsoft ACPI-Compliant System
 (ISA) 0x00000187 (391)	Microsoft ACPI-Compliant System
 (ISA) 0x00000188 (392)	Microsoft ACPI-Compliant System
 (ISA) 0x00000189 (393)	Microsoft ACPI-Compliant System
 (ISA) 0x0000018A (394)	Microsoft ACPI-Compliant System
 (ISA) 0x0000018B (395)	Microsoft ACPI-Compliant System
 (ISA) 0x0000018C (396)	Microsoft ACPI-Compliant System
 (ISA) 0x0000018D (397)	Microsoft ACPI-Compliant System
 (ISA) 0x0000018E (398)	Microsoft ACPI-Compliant System
 (ISA) 0x0000018F (399)	Microsoft ACPI-Compliant System
 (ISA) 0x00000190 (400)	Microsoft ACPI-Compliant System
 (ISA) 0x00000191 (401)	Microsoft ACPI-Compliant System
 (ISA) 0x00000192 (402)	Microsoft ACPI-Compliant System
 (ISA) 0x00000193 (403)	Microsoft ACPI-Compliant System
 (ISA) 0x00000194 (404)	Microsoft ACPI-Compliant System
 (ISA) 0x00000195 (405)	Microsoft ACPI-Compliant System
(ISA) 0x00000196 (406)	Microsoft ACPI-Compliant System
(ISA) 0x00000197 (407)	Microsoft ACPI-Compliant System
(ISA) 0x00000198 (408)	Microsoft ACPI-Compliant System
(ISA) 0x00000199 (409)	Microsoft ACPI-Compliant System
(ISA) 0x0000019A (410)	Microsoft ACPI-Compliant System

 (ISA) 0x0000019B (411)	Microsoft ACPI-Compliant System
 (ISA) 0x0000019C (412)	Microsoft ACPI-Compliant System
 (ISA) 0x0000019D (413)	Microsoft ACPI-Compliant System
 (ISA) 0x0000019E (414)	Microsoft ACPI-Compliant System
 (ISA) 0x0000019F (415)	Microsoft ACPI-Compliant System
 (ISA) 0x000001A0 (416)	Microsoft ACPI-Compliant System
 (ISA) 0x000001A1 (417)	Microsoft ACPI-Compliant System
 (ISA) 0x000001A2 (418)	Microsoft ACPI-Compliant System
 (ISA) 0x000001A3 (419)	Microsoft ACPI-Compliant System
 (ISA) 0x000001A4 (420)	Microsoft ACPI-Compliant System
 (ISA) 0x000001A5 (421)	Microsoft ACPI-Compliant System
 (ISA) 0x000001A6 (422)	Microsoft ACPI-Compliant System
 (ISA) 0x000001A7 (423)	Microsoft ACPI-Compliant System
 (ISA) 0x000001A8 (424)	Microsoft ACPI-Compliant System
 (ISA) 0x000001A9 (425)	Microsoft ACPI-Compliant System
 (ISA) 0x000001AA (426)	Microsoft ACPI-Compliant System
 (ISA) 0x000001AB (427)	Microsoft ACPI-Compliant System
 (ISA) 0x000001AC (428)	Microsoft ACPI-Compliant System
 (ISA) 0x000001AD (429)	Microsoft ACPI-Compliant System
 (ISA) 0x000001AE (430)	Microsoft ACPI-Compliant System
 (ISA) 0x000001AF (431)	Microsoft ACPI-Compliant System
 (ISA) 0x000001B0 (432)	Microsoft ACPI-Compliant System
 (ISA) 0x000001B1 (433)	Microsoft ACPI-Compliant System
 (ISA) 0x000001B2 (434)	Microsoft ACPI-Compliant System
 (ISA) 0x000001B3 (435)	Microsoft ACPI-Compliant System
 (ISA) 0x000001B4 (436)	Microsoft ACPI-Compliant System
 (ISA) 0x000001B5 (437)	Microsoft ACPI-Compliant System
 (ISA) 0x000001B6 (438)	Microsoft ACPI-Compliant System
 (ISA) 0x000001B7 (439)	Microsoft ACPI-Compliant System
 (ISA) 0x000001B8 (440)	Microsoft ACPI-Compliant System
 (ISA) 0x000001B9 (441)	Microsoft ACPI-Compliant System
 (ISA) 0x000001BA (442)	Microsoft ACPI-Compliant System
 (ISA) 0x000001BB (443)	Microsoft ACPI-Compliant System
 (ISA) 0x000001BC (444)	Microsoft ACPI-Compliant System
 (ISA) 0x000001BD (445)	Microsoft ACPI-Compliant System
 (ISA) 0x000001BE (446)	Microsoft ACPI-Compliant System
 (ISA) 0x000001BF (447)	Microsoft ACPI-Compliant System
 (ISA) 0x000001C0 (448)	Microsoft ACPI-Compliant System
 (ISA) 0x000001C1 (449)	Microsoft ACPI-Compliant System
 (ISA) 0x000001C2 (450)	Microsoft ACPI-Compliant System
 (ISA) 0x000001C3 (451)	Microsoft ACPI-Compliant System
 (ISA) 0x000001C4 (452)	Microsoft ACPI-Compliant System
 (ISA) 0x000001C5 (453)	Microsoft ACPI-Compliant System
 (ISA) 0x000001C6 (454)	Microsoft ACPI-Compliant System
 (ISA) 0x000001C7 (455)	Microsoft ACPI-Compliant System
(ISA) 0x000001C8 (456)	Microsoft ACPI-Compliant System
(ISA) 0x000001C9 (457)	Microsoft ACPI-Compliant System
(ISA) 0x000001CA (458)	Microsoft ACPI-Compliant System
(ISA) 0x000001CB (459)	Microsoft ACPI-Compliant System
(ISA) 0x000001CC (460)	Microsoft ACPI-Compliant System
(ISA) 0x000001CD (461)	Microsoft ACPI-Compliant System
(ISA) 0x000001CE (462)	Microsoft ACPI-Compliant System

 (ISA) 0x000001CF (463)	Microsoft ACPI-Compliant System
 (ISA) 0x000001D0 (464)	Microsoft ACPI-Compliant System
 (ISA) 0x000001D1 (465)	Microsoft ACPI-Compliant System
 (ISA) 0x000001D2 (466)	Microsoft ACPI-Compliant System
 (ISA) 0x000001D3 (467)	Microsoft ACPI-Compliant System
 (ISA) 0x000001D4 (468)	Microsoft ACPI-Compliant System
 (ISA) 0x000001D5 (469)	Microsoft ACPI-Compliant System
 (ISA) 0x000001D6 (470)	Microsoft ACPI-Compliant System
 (ISA) 0x000001D7 (471)	Microsoft ACPI-Compliant System
 (ISA) 0x000001D8 (472)	Microsoft ACPI-Compliant System
 (ISA) 0x000001D9 (473)	Microsoft ACPI-Compliant System
 (ISA) 0x000001DA (474)	Microsoft ACPI-Compliant System
 (ISA) 0x000001DB (475)	Microsoft ACPI-Compliant System
 (ISA) 0x000001DC (476)	Microsoft ACPI-Compliant System
 (ISA) 0x000001DD (477)	Microsoft ACPI-Compliant System
 (ISA) 0x000001DE (478)	Microsoft ACPI-Compliant System
 (ISA) 0x000001DF (479)	Microsoft ACPI-Compliant System
 (ISA) 0x000001E0 (480)	Microsoft ACPI-Compliant System
 (ISA) 0x000001E1 (481)	Microsoft ACPI-Compliant System
 (ISA) 0x000001E2 (482)	Microsoft ACPI-Compliant System
 (ISA) 0x000001E3 (483)	Microsoft ACPI-Compliant System
 (ISA) 0x000001E4 (484)	Microsoft ACPI-Compliant System
 (ISA) 0x000001E5 (485)	Microsoft ACPI-Compliant System
 (ISA) 0x000001E6 (486)	Microsoft ACPI-Compliant System
 (ISA) 0x000001E7 (487)	Microsoft ACPI-Compliant System
 (ISA) 0x000001E8 (488)	Microsoft ACPI-Compliant System
 (ISA) 0x000001E9 (489)	Microsoft ACPI-Compliant System
 (ISA) 0x000001EA (490)	Microsoft ACPI-Compliant System
 (ISA) 0x000001EB (491)	Microsoft ACPI-Compliant System
 (ISA) 0x000001EC (492)	Microsoft ACPI-Compliant System
 (ISA) 0x000001ED (493)	Microsoft ACPI-Compliant System
 (ISA) 0x000001EE (494)	Microsoft ACPI-Compliant System
 (ISA) 0x000001EF (495)	Microsoft ACPI-Compliant System
 (ISA) 0x000001F0 (496)	Microsoft ACPI-Compliant System
 (ISA) 0x000001F1 (497)	Microsoft ACPI-Compliant System
 (ISA) 0x000001F2 (498)	Microsoft ACPI-Compliant System
 (ISA) 0x000001F3 (499)	Microsoft ACPI-Compliant System
 (ISA) 0x000001F4 (500)	Microsoft ACPI-Compliant System
 (ISA) 0x000001F5 (501)	Microsoft ACPI-Compliant System
 (ISA) 0x000001F6 (502)	Microsoft ACPI-Compliant System
 (ISA) 0x000001F7 (503)	Microsoft ACPI-Compliant System
 (ISA) 0x000001F8 (504)	Microsoft ACPI-Compliant System
 (ISA) 0x000001F9 (505)	Microsoft ACPI-Compliant System
 (ISA) 0x000001FA (506)	Microsoft ACPI-Compliant System
 (ISA) 0x000001FB (507)	Microsoft ACPI-Compliant System
 (ISA) 0x000001FC (508)	Microsoft ACPI-Compliant System
 (ISA) 0x000001FD (509)	Microsoft ACPI-Compliant System
(ISA) 0x000001FE (510)	Microsoft ACPI-Compliant System
(ISA) 0x000001FF (511)	Microsoft ACPI-Compliant System
(PCI) 0x00000010 (16)	High Definition Audio Controller
(PCI) 0xFFFFFEEA (-22)	Intel(R) Ethernet Connection (18) I219-LM
(PCI) 0xFFFFFEEB (-21)	Intel(R) Reserved Device

	(PCI) 0xFFFFFED (-19)	Intel(R) Ethernet Controller I226-LM
	(PCI) 0xFFFFFEE (-18)	Intel(R) Ethernet Controller I226-LM
	(PCI) 0xFFFFFEF (-17)	Intel(R) Ethernet Controller I226-LM
	(PCI) 0xFFFFFFF0 (-16)	Intel(R) Ethernet Controller I226-LM
	(PCI) 0xFFFFFFF1 (-15)	Intel(R) Ethernet Controller I226-LM
	(PCI) 0xFFFFFFF2 (-14)	Intel(R) Ethernet Controller I226-LM
	(PCI) 0xFFFFFFF3 (-13)	Intel(R) Ethernet Controller I226-LM
	(PCI) 0xFFFFFFF4 (-12)	Intel(R) Ethernet Controller I226-LM
	(PCI) 0xFFFFFFF5 (-11)	Intel(R) Ethernet Controller I226-LM
	(PCI) 0xFFFFFFF6 (-10)	Intel(R) Ethernet Controller I226-LM
	(PCI) 0xFFFFFFF7 (-9)	Intel(R) Ethernet Controller I226-LM
	(PCI) 0xFFFFFFF8 (-8)	Intel(R) Ethernet Controller I226-LM
	(PCI) 0xFFFFFFF9 (-7)	Intel(R) USB 3.20 eXtensible Host Controller - 1.20 (Microsoft)
	(PCI) 0xFFFFFFFA (-6)	Intel(R) Graphics
	(PCI) 0xFFFFFFFB (-5)	Intel(R) USB 3.20 eXtensible Host Controller - 1.20 (Microsoft)
	(PCI) 0xFFFFFFFC (-4)	Intel(R) Management Engine Interface #1
	(PCI) 0xFFFFFFFD (-3)	Standard SATA AHCI Controller
	(PCI) 0xFFFFF000 (-2)	PCI Express Root Port

B.3 Memory Address Map

Address Range	Device Name
[0000004000000000 - 000003FFBFFFFFFF]	PCI Express Root Complex
[0000000000000000 - 0000000000000FFF]	Motherboard resources
[0000000000000000 - 0000000000000FFF]	Motherboard resources
[000000000000A0000 - 000000000000BFFFFFFF]	PCI Express Root Complex
[00000000800000000 - 000000008000FFFFFFF]	Intel(R) Ethernet Controller I226-LM
[00000000800000000 - 00000000801FFFFFFF]	PCI Express Root Port
[00000000800000000 - 00000000BFFFFFFF]	PCI Express Root Complex
[00000000801000000 - 0000000080103FFF]	Intel(R) Ethernet Controller I226-LM
[00000000802200000 - 0000000080221FFF]	Standard SATA AHCI Controller
[00000000802220000 - 00000000802227FF]	Standard SATA AHCI Controller
[00000000802230000 - 00000000802230FF]	Standard SATA AHCI Controller
[00000000BFFE00000 - 00000000BFFFFFFF]	Intel(R) Ethernet Connection (18) I219-LM
[00000000C00000000 - 00000000CFFFFFFF]	Motherboard resources
[00000000E0D100000 - 00000000E0D1FFFF]	Intel(R) Serial IO GPIO Host Controller - INTC1083
[00000000E0D200000 - 00000000E0D2FFFF]	Intel(R) Serial IO GPIO Host Controller - INTC1083
[00000000E0D300000 - 00000000E0D3FFFF]	Intel(R) Serial IO GPIO Host Controller - INTC1083
[00000000E0D400000 - 00000000E0D4FFFF]	Intel(R) Serial IO GPIO Host Controller - INTC1083
[00000000E0D500000 - 00000000E0D5FFFF]	Intel(R) Serial IO GPIO Host Controller - INTC1083
[00000000FC8000000 - 00000000FCB1FFFF]	Motherboard resources
[00000000FE0100000 - 00000000FE010FFF]	Intel(R) SPI - 7E23
[00000000FED000000 - 00000000FED003FF]	High precision event timer
[00000000FED200000 - 00000000FED7FFFF]	Motherboard resources
[00000000FED400000 - 00000000FED44FFF]	Trusted Platform Module 2.0
[00000000FED450000 - 00000000FED8FFFF]	Motherboard resources
[00000000FEDC00000 - 00000000FEDC7FFF]	Motherboard resources
[00000000FEE000000 - 00000000FEEFFFFFFF]	Motherboard resources
[00000040000000000 - 000000400FFFFFFF]	Intel(R) Graphics
[00000040100000000 - 0000004010FFFFFFF]	Intel(R) Graphics
[00000040202400000 - 000000402024FFFF]	Intel(R) USB 3.20 eXtensible Host Controller - 1.20 (Microsoft)
[00000040202500000 - 000000402025FFFF]	Intel(R) USB 3.20 eXtensible Host Controller - 1.20 (Microsoft)
[00000040202680000 - 00000040202680FF]	Intel(R) SMBus - 7E22
[00000040202690000 - 0000004020269FFF]	Intel(R) Management Engine Interface #1
[000003FFB00000000 - 000003FFB7FFFFFFF]	Intel(R) Reserved Device
[000003FFBFC000000 - 000003FFBFDFFFFFFF]	High Definition Audio Controller
[000003FFBFB000000 - 000003FFBFBFFFFFFF]	Intel(R) Reserved Device
[000003FFBFBFC0000 - 000003FFBFBFFFFFFF]	High Definition Audio Controller
[000003FFBFFC00000 - 000003FFBFFFFFFF]	Intel(R) Platform Monitoring Technology (PMT) Driver