

MIX-H310D2



Industrial Motherboard

Copyright Notice

This document is copyrighted, 2024. All rights are reserved. The original manufacturer reserves the right to make improvements to the products described in this manual at any time without notice.

No part of this manual may be reproduced, copied, translated, or transmitted in any form or by any means without the prior written permission of the original manufacturer. Information provided in this manual is intended to be accurate and reliable. However, the original manufacturer assumes no responsibility for its use, or for any infringements upon the rights of third parties that may result from its use. The material in this document is for product information only and is subject to change without notice. While reasonable efforts have been made in the preparation of this document to assure its accuracy, the original manufacturer assumes no liabilities resulting from errors or omissions in this document, or from the use of the information contained herein.

The original manufacturer reserves the right to make changes in the product design without notice to its users.

Acknowledgments

All other products' name or trademarks are properties of their respective owners.

- AMI is a trademark of American Megatrends Inc.
- Intel®, Core™ are trademarks of Intel® Corporation.
- Microsoft Windows® is a registered trademark of Microsoft Corp.
- IBM, PC/AT, PS/2, and VGA are trademarks of International Business Machines Corporation.

The original manufacturer reserves the right to make changes in the product design without notice to its users.

All other product names or trademarks are properties of their respective owners.

Contents

Chapter 1	Product overview	
1.1	Package contents.....	1-1
1.2	Features	1-1
1.3	Specifications.....	1-2
Chapter 2	Motherboard information	
2.1	Before you proceed	2-1
2.2	Motherboard layout.....	2-2
2.3	Screw size.....	2-4
	2.3.1 Component side.....	2-4
	2.3.2 Solder side	2-5
2.4	Central Processing Unit (CPU)	2-6
	2.4.1 Installing the CPU	2-7
	2.4.2 CPU heatsink and fan assembly installation.....	2-9
2.5	System memory	2-11
2.6	Jumpers	2-12
2.7	Connectors	2-16
	2.7.1 Rear panel connectors.....	2-16
	2.7.2 Internal connectors	2-17
Chapter 3	BIOS setup	
3.1	BIOS setup.....	3-1
3.2	Main menu	3-2
	3.2.1 System Date [Day MM/DD/YYYY]	3-2
	3.2.2 System Time [HH:MM:SS]	3-2
3.3	Advanced menu	3-2
	3.3.1 CPU Configuration	3-2
	3.3.2 Trusted Computing	3-3
	3.3.3 SATA Configuration	3-4
	3.3.4 USB Configuration	3-4
	3.3.5 Hardware Monitor	3-4
	3.3.6 SIO Configuration	3-6
	3.3.7 AMT Configuration	3-7
	3.3.8 PCH-FW Configuration	3-7
	3.3.9 Power Management.....	3-7
	3.3.10 Digital IO Port Configuration	3-8

3.4	Chipset menu	3-8
3.4.1	System Agent (SA) Configuration	3-8
3.4.2	PCH-IO Configuration	3-9
3.5	Security menu	3-9
3.5.1	Administrator Password	3-9
3.5.2	User Password.....	3-9
3.6	Boot menu	3-10
3.6.1	Boot Configuration	3-10
3.6.2	FIXED BOOT ORDER Priorities	3-10
3.7	Save & Exit menu	3-11
 Appendix		
	Notices.....	A-1

Chapter 1

Product overview

1.1 Package contents

Check your industrial motherboard package for the following items.

- 1 x Industrial Motherboard
- 1 x SATA 6.0Gb/s cable
- 1 x SATA power cable
- 1 x I/O Shield



If any of the above items is damaged or missing, contact your distributor or sales representative immediately.

1.2 Features

- Intel® 8th/9th Generation (Coffee Lake S) Core™ i7/ i5/ i3, Pentium® LGA1151 socket processor (6-core)
- 2 x SO-DIMMs, max. 64GB, DDR4 2400/2666 MHz, non-ECC (vertical type), Dual channel memory
- 2 x SATA 6.0 Gb/s ports, 4 x USB 3.2 Gen 1 ports, 5 x USB 2.0 ports
- Realtek ALC887 High Definition Audio CODEC
- Multi Display: 2 x HDMI1.4, 1 x eDP, 1 x VGA (optional)
- Dual Ethernet LAN: 1 x Intel® PCIe Gb LAN 219V, 1 x Intel® PCIe Gb LAN 211AT
- 1 x PCIe 3.0 [x16] slot
- 1 x M.2 slot (E-key), 22 x 30mm (PCIe colay CNVi)
1 x M.2 slot (M-key), 2280/2242 (PCIex1 Gen2)

1.3 Specifications

SYSTEM	
CPU	Intel® 8 th /9 th Generation (Coffee Lake S) Core™ i7/ i5/ i3, Pentium® LGA1151 socket processor, max. 65W TDPs (6-core)
Chipset	Intel® H310 Express Chipset
Memory	2 x SO-DIMMs, max. 64GB, DDR4 2400/2666 MHz, non-ECC (Vertical Type) memory Dual channel memory architecture
I/O Chipset	NCT6793D
Storage	2 x SATA 6.0Gb/s ports 1 x M.2 slot (M-Key), 2280/2242 (PCIe x 1 Gen 2)
Ethernet	1 x Intel® i219V Gigabit LAN 1 x Intel® i211AT Gigabit LAN
Audio	Realtek ALC887
TPM	NPCT750AABYX TPM 2.0 (Optional)
Expansion slots	1 x PCIe 3.0 [x16] slot 1 x M.2 slot (E-Key), 2230 (PCIe colay CNVi)
BIOS	256Mbit Flash ROM, AMI BIOS
H/W Status Monitor	Monitors CPU/system temperature Monitors Vcore/5V/12V voltage Monitors CPU/chassis fan speed
Watchdog Timer	1~255 steps by software program
Smart Fan Control	CPU Fan (3.3V/5V PWM control) / Chassis Fan
Wake On LAN / PXE	Yes (WOL, PXE)
Power States	S3, S4, S5
Graphics	
Graphics Multi Display	2 x HDMI1.4 + 1 x eDP
Resolution	VGA: Up to 1920 x 1200 @ 60 Hz (optional) HDMI: 3840 x 2160 @24 Hz (HDMI 1.4) eDP: 4096 x 2160 @ 24 Hz / 3840 x 2160 @ 60 Hz
Environment, Power, and ME	
Battery	Lithium battery
Power requirement	12V/16A DC-IN
Operating temperature	32°F~140°F (0°C~60°C)
Operating humidity	60°C @ 90% RH Non-Condensing
Certificate	CE & FCC
Form factor	Mini ITX Form Factor: 6.7" x 6.7" (170mm x 170mm)
Weight	1.1 lb (0.5 Kg)

(continued on the next page)

I/O	
Storage	2 x SATA 6.0Gb/s ports 1 x M.2 slot (M-key), 2242/2280 (PCIe x 1 Gen2)
USB	4 x USB 3.2 Gen 1 ports (4 ports in Rear I/O) 5 x USB 2.0 ports (4 ports in Rear I/O; 1 internal header)
Display	2 x HDMI +1 x VGA (optional) + 1 x eDP
Serial port	1 x RS-232/422/485 supports 5V/12V/RI option (Internal) 1 x RS-232 (internal)
LAN	2 x LAN (RJ-45) ports
Audio	Mic-in, Line-out, 1x AAFP
DIO	8-bit Digital I/O interface (4-in/ 4-out)
FAN	1 x CPU fan header (4-pin) 1 x Chassis fan header (4-pin)
Placement	
Back Panel I/O Ports	1 x 12V DC power Jack 1 x VGA port (optional) 2 x HDMI1.4 ports 4 x USB 2.0 ports 2 x [1x LAN (RJ45) port + 2 x USB 3.2 Gen 1 ports] 2 x Audio jacks for Mic-in & Line out
Internal I/O Connectors	1 x PCIe 3.0 [x16] slot (Max:75W) 1 x M.2 slot (M-Key), 2242/2280 (PCIe x 1 Gen2) 1 x M.2 slot (E-Key), 2230 (PCIe/CNV1) 2 x SATA 6.0Gb/s ports 1 x USB 2.0 header supports additional 1 USB port (2.00 mm) 2 x box headers for COM (COM1: RS-232/422/485 supports 5V/12V/RI, COM2: RS-232) 1 x Digital I/O box header 2 x 4-pin (2x2) internal power connectors 1 x 4-pin SATA power connector 1 x Panel 3.3V/ 5V selection jumper 1 x Panel backlight 12V/ 5V selection jumper 1 x 40-pin eDP connector 1 x 4-pin CPU Fan header 1 x 4-pin Chassis Fan header 1 x System Panel header 1 x Front Panel Audio header (AAFP) 1 x Chassis Intrusion follow ASUS pin out 1 x Buzzer on board 1 x AT/ATX mode selection jumper (Default: No) 1 x clear CMOS jumper

(continued on the next page)

Others	
OS support	Windows® 10 64-bit Linux Ubuntu 18.04.2
Accessories	1 x SATA cable 1 x SATA power cable 1 x I/O shield



NOTE: Specifications are subject to change without notice.

Chapter 2

Motherboard information

2.1 Before you proceed

Take note of the following precautions before you install motherboard components or change any motherboard settings.



CAUTION!

- Unplug the power cord from the wall socket before touching any component.
 - Before handling components, use a grounded wrist strap or touch a safely grounded object or a metal object, such as the power supply case, to avoid damaging them due to static electricity.
 - Hold components by the edges to avoid touching the ICs on them.
 - Whenever you uninstall any component, place it on a grounded antistatic pad or in the bag that came with the component.
 - Before you install or remove any component, ensure that the ATX power supply is switched off or the power cord is detached from the power supply. Failure to do so may cause severe damage to the motherboard, peripherals, or components.
-

2.2 Motherboard layout



NOTE: Place four screws into the holes indicated by circles to secure the motherboard to the chassis.



CAUTION! Do not overtighten the screws! Doing so can damage the motherboard.

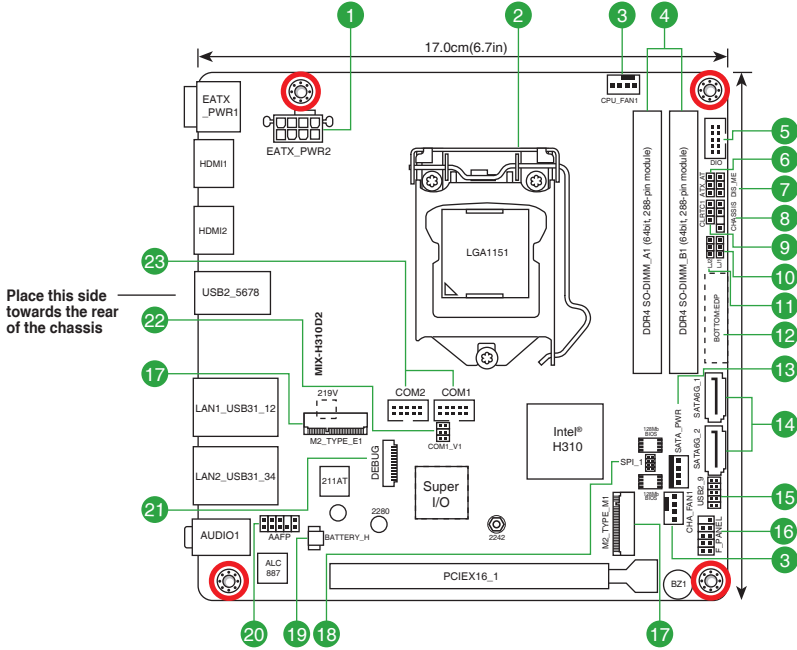

Connectors/Jumpers/Slots		Page
1.	12VDC connector (8-pin EATX_PWR2)	2-17
2.	Intel® LGA1151 CPU socket	2-6
3.	CPU and Chassis Fan headers (4-pin CPU_FAN1, 4-pin CHA_FAN1)	2-17
4.	DDR4 DIMM slots	2-11
5.	Digital I/O connector (10-pin DIO)	2-18
6.	AT/ATX mode selection (3-pin ATX_AT)	2-14
7.	Intel® ME Jumper (3-pin DIS_ME)	2-13
8.	Chassis intrusion jumper (4-1 pin CHASSIS)	2-14
9.	Clear RTC RAM (3-pin CLRTC1)	2-12
10.	eDP voltage selection (3-pin LJ1)	2-15
11.	Panel backlight selection (3-pin LJ2)	2-15
12.	Embedded DisplayPort (40-pin eDP)	2-18
13.	SATA power header (SATA_PWR)	2-19
14.	SATA 6.0Gb/s ports (7-pin SATA6G_1~2)	2-19
15.	USB 2.0 header (10-pin USB9)	2-20
16.	System Panel header (10-1 pin F_PANEL)	2-21
17.	M.2 M-Key and M.2 E-Key slots	2-20
18.	BIOS programmable header (8-pin SPI_1)	2-21
19.	Battery connector (2-pin BATTERY_H)	2-22
20.	Front Panel Audio header (10-1 pin AAFP)	2-22
21.	Debug Card connector	2-23
22.	COM1 Ring/+5V/+12V selection jumper (6-pin COM1_V1)	2-13
23.	Serial Port headers (10-pin COM1~2)	2-23

2.3 Screw size

2.3.1 Component side

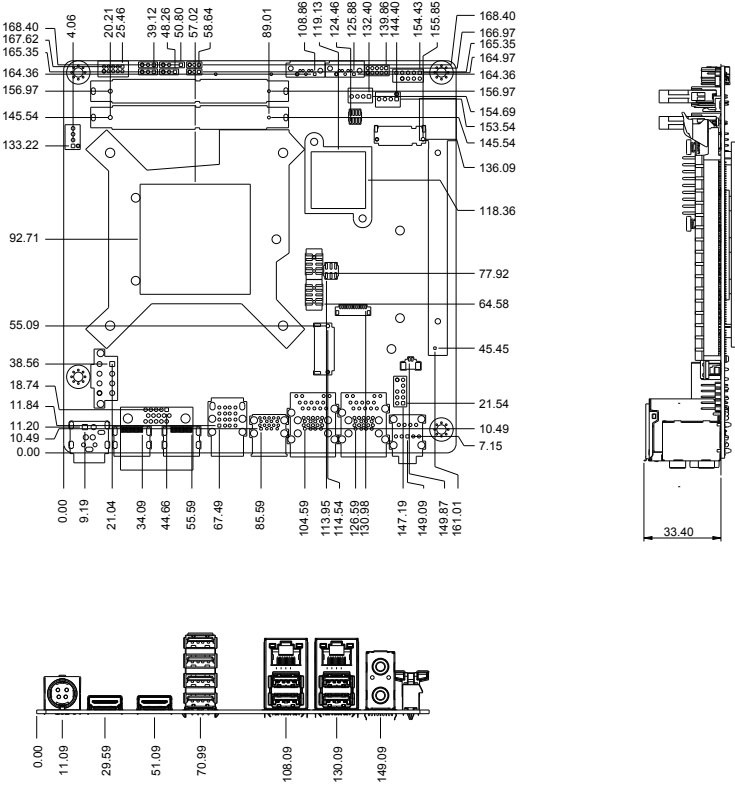

2.3.2 Solder side

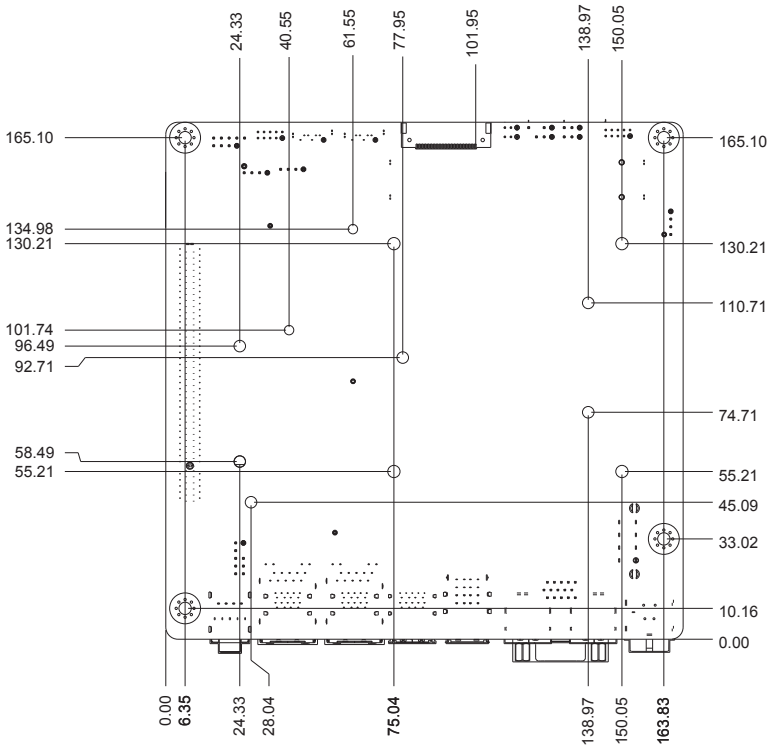

2.4 Central Processing Unit (CPU)

This motherboard comes with an Intel® 8th/9th Generation (Coffee Lake S) Core™ i7 / i5 / i3, Pentium® LGA 1151 socket processor.

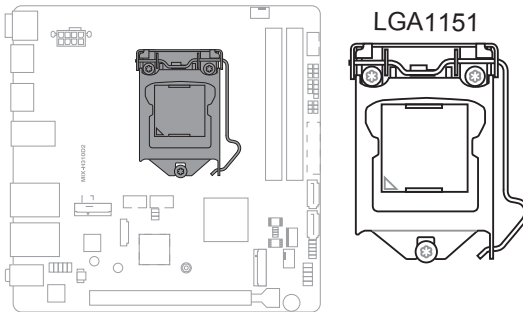

IMPORTANT: Unplug all power cables before installing the CPU.



CAUTION!

- Upon purchase of the motherboard, ensure that the PnP cap is on the socket and the socket contacts are not bent. Contact your retailer immediately if the PnP cap is missing, or if you see any damage to the PnP cap/socket contacts/motherboard components.
 - Keep the cap after installing the motherboard. The manufacturer will process Return Merchandise Authorization (RMA) requests only if the motherboard comes with the cap on the LGA1151 socket.
 - The product warranty does not cover damage to the socket contacts resulting from incorrect CPU installation/removal, or misplacement/loss/incorrect removal of the PnP cap.
-

2.4.1 Installing the CPU



CAUTION! Ensure that you install the correct CPU designed for LGA1151 only. DO NOT install a CPU designed for LGA1155 and LGA1156 sockets on the LGA1151 socket.

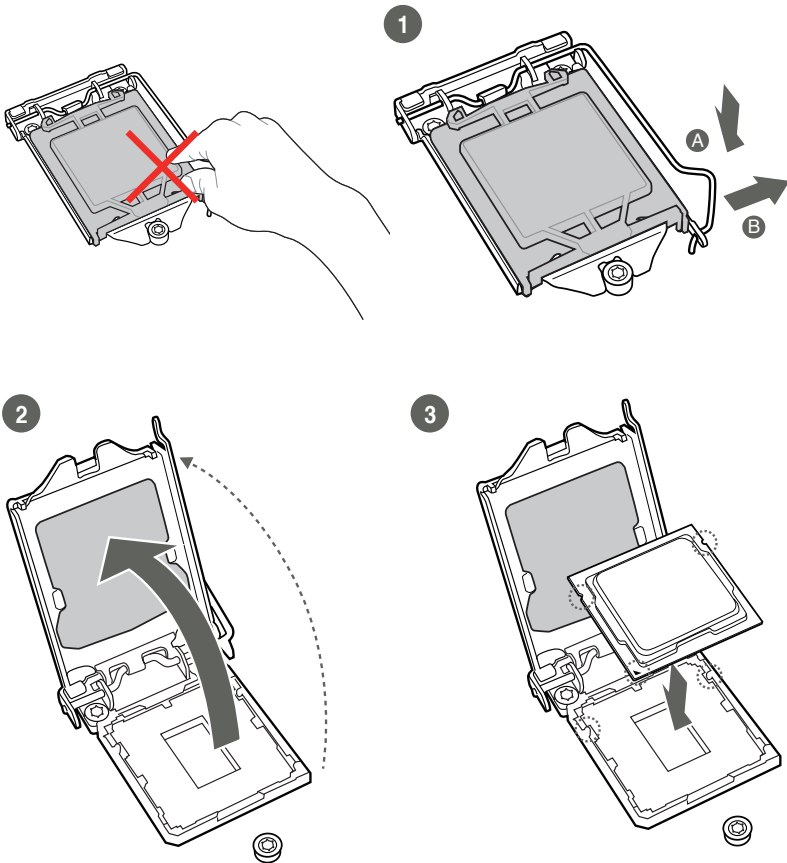

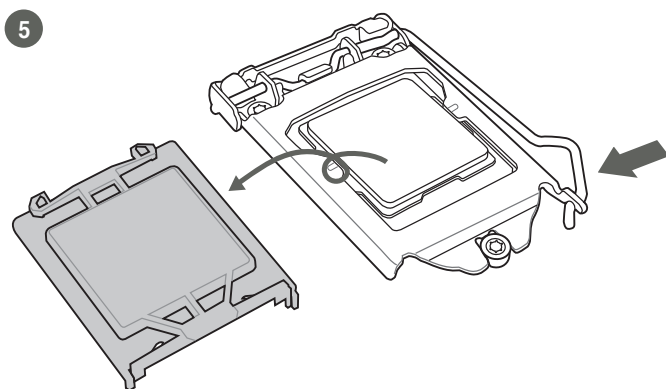
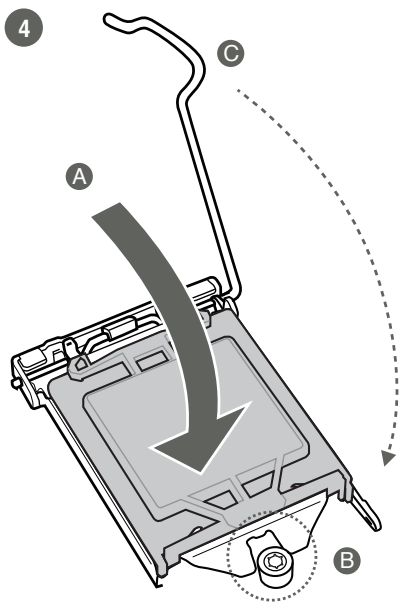

2.4.2 CPU heatsink and fan assembly installation

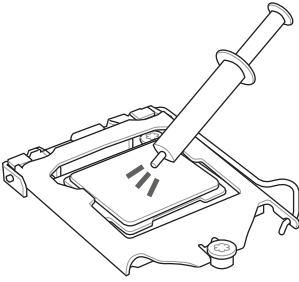

CAUTION! Apply the Thermal Interface Material to the CPU heatsink and CPU before you install the heatsink and fan if necessary.

To install the CPU heatsink and fan assembly

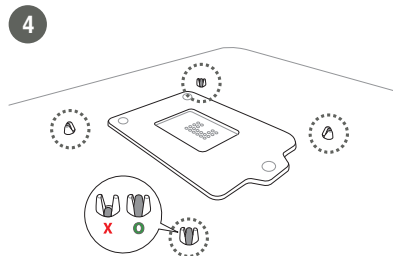
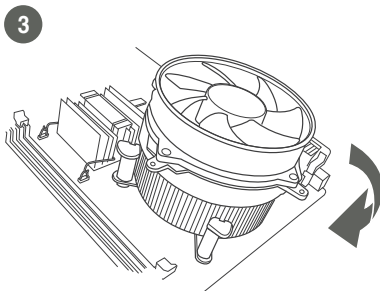
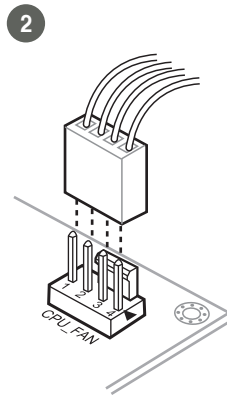
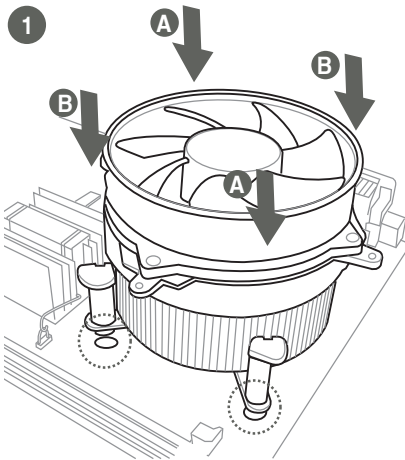

To uninstall the CPU heatsink and fan assembly

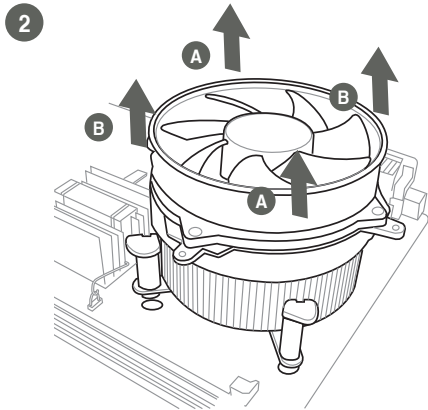
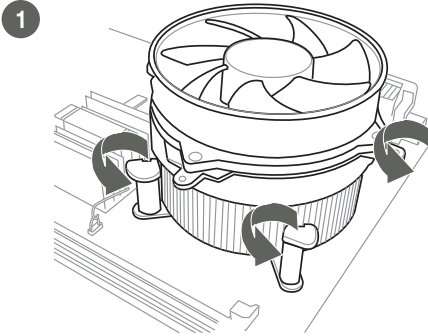

2.5 System memory

This motherboard comes with two Double Data Rate 4 (DDR4) Small Outline Dual Inline Memory Modules (SO-DIMM) sockets. The figure illustrates the location of the DDR4 DIMM sockets:

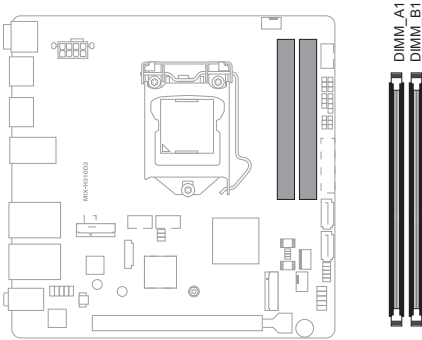

NOTE: Use the DIMM_A1 slot when inserting only one SO-DIMM.

Installing a DIMM

To install a DIMM

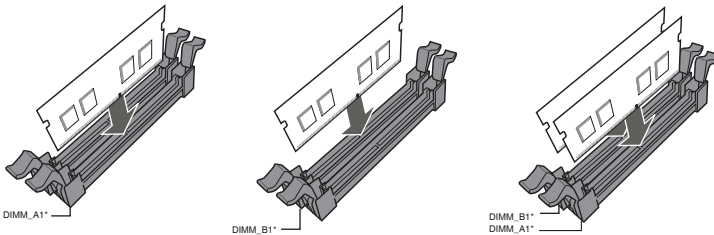

To remove a DIMM

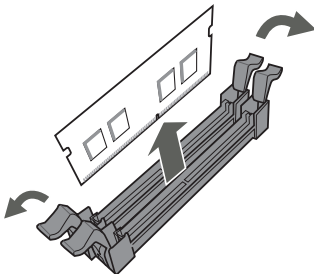

2.6 Jumpers

1. Clear RTC RAM (3-pin CLRTC1)

This jumper allows you to clear the Real Time Clock (RTC) RAM in CMOS. You can clear the CMOS memory of system setup parameters by erasing the CMOS RTC RAM data. The onboard button cell battery powers the RAM data in CMOS, which include system setup information such as system passwords.

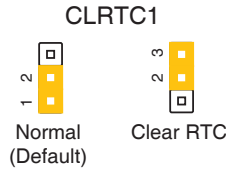
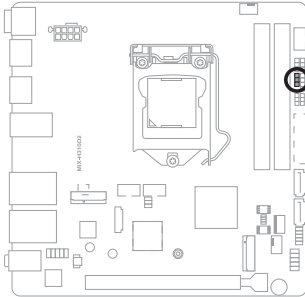

To erase the RTC RAM:

1. Turn OFF the computer and unplug the power cord.
2. Move the jumper cap from pins 1-2 (default) to pins 2-3. Keep the cap on pins 2-3 for about 5~10 seconds, then move the cap back to pins 1-2.
3. Plug the power cord and turn ON the computer.
4. Hold down the key during the boot process and enter BIOS setup to reenter data.



CAUTION! Except when clearing the RTC RAM, never remove the cap on CLRTC jumper default position. Removing the cap will cause system boot failure!



NOTES:

- If the steps above do not help, remove the onboard battery and move the jumper again to clear the CMOS RTC RAM data. After clearing the CMOS, reinstall the battery.
 - You do not need to clear the RTC when the system hangs due to overclocking. For system failure due to overclocking, use the CPU Parameter Recall (C.P.R) feature. Shut down and reboot the system so the BIOS can automatically reset parameter settings to default values.
-

2. COM1 Ring/+5V/+12V selection jumper (6-pin COM1_V1)

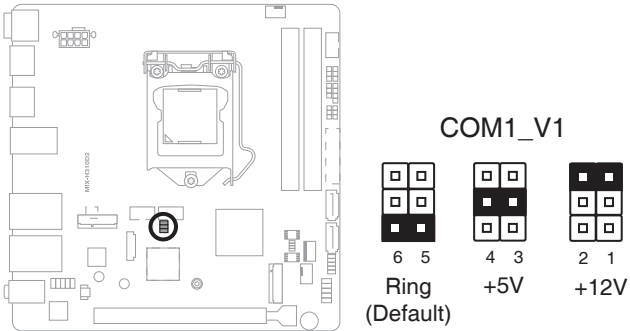

Setting	Pins
+12V	1-2
+5V	3-4
Ring (Default)	5-6

3. Intel® ME Jumper (3-pin DIS_ME)

This jumper allows you to force the Intel® Management Engine (ME) to boot from recovery mode when ME becomes corrupted.

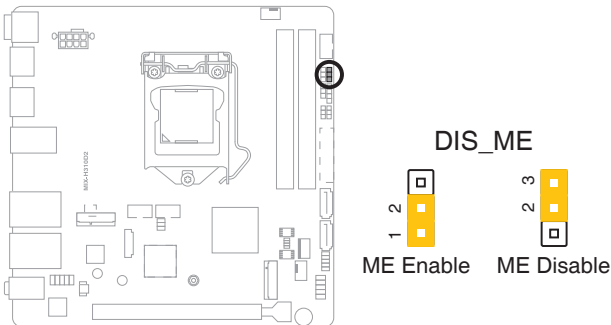

4. AT/ATX mode selection (3-pin ATX_AT)

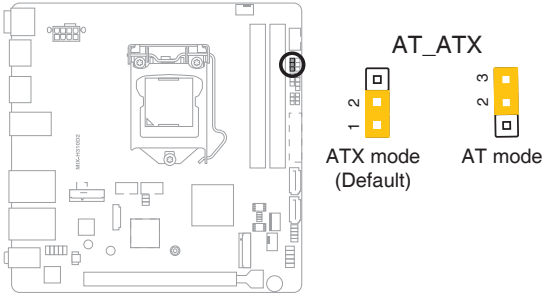

	Pins
ATX mode (Default)	1-2
AT mode	2-3

5. Chassis intrusion jumper (4-1 pin CHASSIS)

This connector is for a chassis-mounted intrusion detection sensor or switch. Connect one end of the chassis intrusion sensor or switch cable to this connector. The chassis intrusion sensor or switch sends a high-level signal to this connector when a chassis component is removed or replaced. The signal is then generated as a chassis intrusion event.

Move the jumper cap to pins 1-2 when you intend to use the chassis intrusion detection feature.

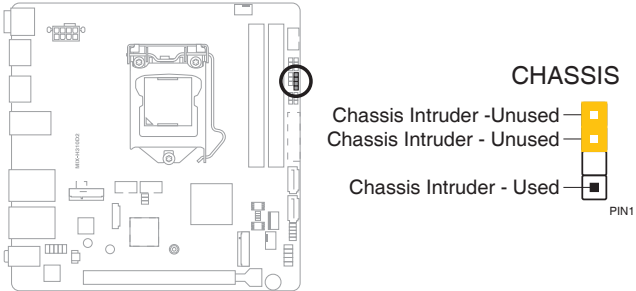

Pins	
1-2	Enables the chassis intrusion detection feature
3-4	Disables the chassis intrusion detection feature (Default)

6. eDP voltage selection (3-pin LJ1)

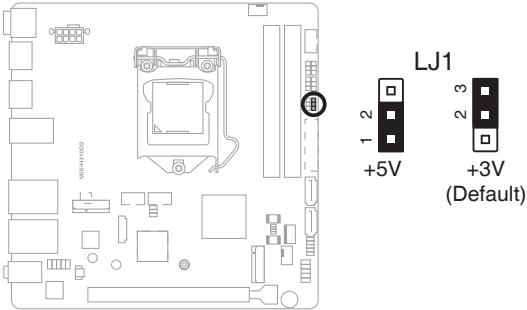

Setting	Pins
+5V	1-2
+3.3V (Default)	2-3

7. Panel backlight selection (3-pin J2)

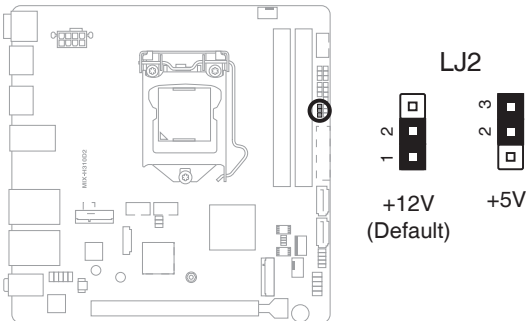

Setting	Pins
12V (Default)	1-2
5V	2-3

2.7 Connectors

2.7.1 Rear panel connectors

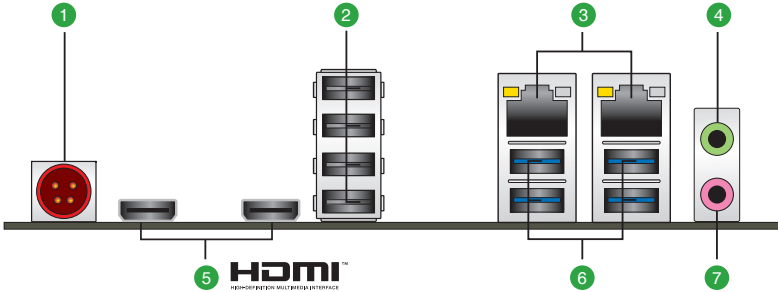

- DC power connector.** Insert the power adapter into this port.
- USB 2.0 ports.** These four 4-pin Universal Serial Bus (USB) ports are available for connecting USB 2.0/1.1 devices.
- LAN (RJ-45) ports.** These ports allow Gigabit connection to a Local Area Network (LAN) through a network hub. Refer to the table below for the LAN port LED indications.

LAN port LED indications

ACT/LINK LED		SPEED LED	
Status	Description	Status	Description
Off	No link	Off	10 Mbps connection
Orange	Linked	Orange	100 Mbps connection
Orange (Blinking)	Data activity	Green	1 Gbps connection
Orange (Blinking then steady)	Ready to wake up from S5 mode	—	—

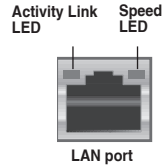

- Line Out port (lime).** This port connects to a headphone or a speaker.
- HDMI™ ports.** These ports are for High-Definition Multimedia Interface (HDMI™) connectors, and are HDCP compliant allowing playback of HD DVD, Blu-ray, and other protected content.
- USB 3.2 Gen 1 ports.** These 9-pin Universal Serial Bus (USB) ports connect to USB 3.2 Gen 1 devices.
- Microphone port (pink).** This port connects to a microphone.

2.7.2 Internal connectors

1. Internal power connectors (8-pin EATX_PWR2)

This connector is for an EATX power supply plug. The power supply plug is designed to fit this connector in only one orientation. Find the proper orientation and push down firmly until the connector completely fits.

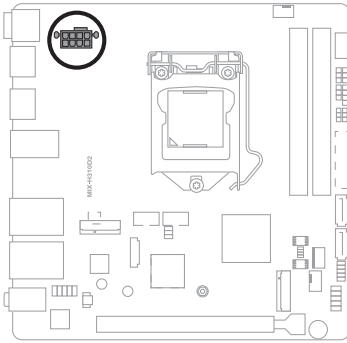

EATX_PWR2

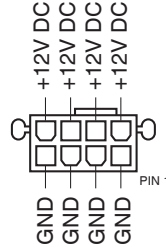

IMPORTANT:

- For a fully configured system, we recommend that you use a power supply unit (PSU) that complies with ATX 12V Specification 2.0 (or later version).
- We recommend that you use a PSU with higher power output when configuring a system with more power-consuming devices. The system may become unstable or may not boot up if the power is inadequate.



For safety purpose, use **ONLY** the bundled power adapter to avoid damaging your motherboard.

2. Chassis / CPU Fan headers (4-pin CHA_FAN1, 4-pin CPU_FAN1)

Connect the fan cables to the fan headers on the motherboard, ensuring that the black wire of each cable matches the ground pin of the header.

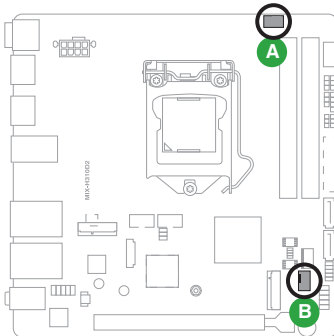

A CPU_FAN1

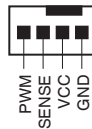

B CHA_FAN1

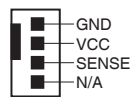

CAUTION: Do not forget to connect the fan cables to the fan connectors. Insufficient air flow inside the system may damage the motherboard components. These are not jumpers! Do not place jumper caps on the fan connectors!

3. Digital I/O header (10-pin DIO)

This header includes 8 I/O lines (In/Out programmable). All of the Digital I/O lines are programmable and each I/O pin can be individually programmed to support various devices.

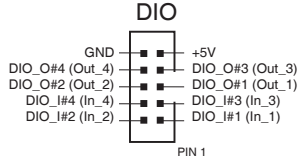
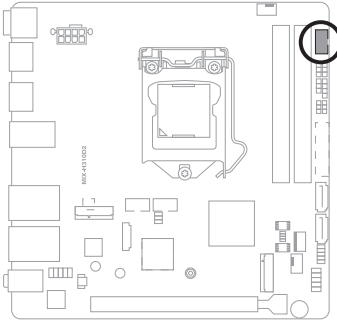

NOTE: To configure the I/O pins in BIOS, go to the **Advanced** tab > **Digital IO Port Configuration**. See section 3.3.10 **Digital IO Port Configuration** for details.

4. Embedded DisplayPort connector (40-pin eDP)

This connector is for an internal embedded DisplayPort connection.

EDP(BOTTOM)

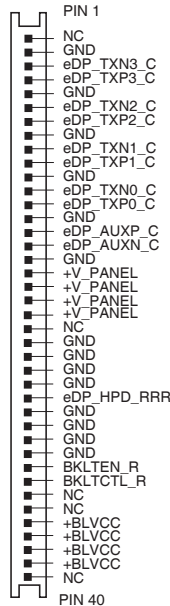
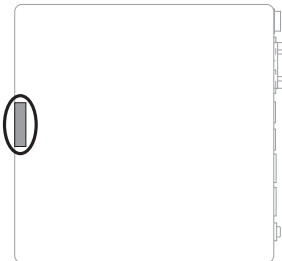

5. SATA Power header (4-pin SATA_PWR)

This header is for the SATA power cable. The power cable plug is designed to fit this header in only one orientation. Find the proper orientation and push down firmly until the header completely fit.

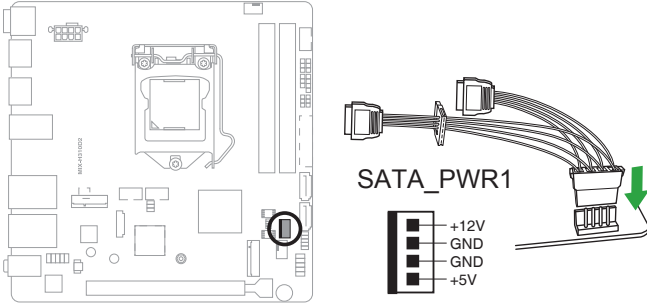

IMPORTANT: The SATA Power header supports 1A current to the maximum.

6. SATA 6.0Gb/s connectors (7-pin SATA6G_1-2)

These connectors connect to Serial ATA 6.0 Gb/s hard disk drives via Serial ATA 6.0 Gb/s signal cables.

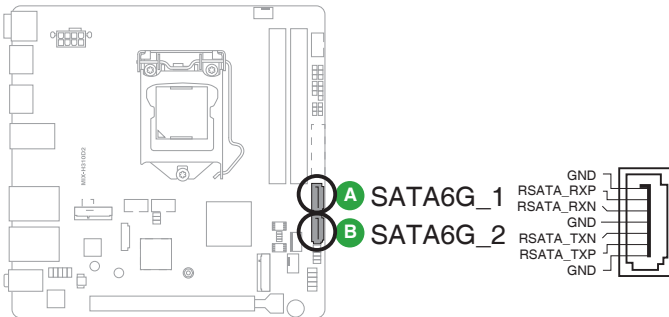

IMPORTANT: When using hot-plug and NCQ, set the SATA Mode Selection item in the BIOS to [AHCI]. See section 3.3.3 **SATA Configuration** for details.

7. USB 2.0 header (10-pin USB9)

This USB header complies with USB 2.0 specifications.

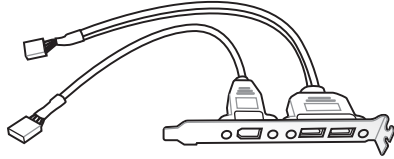
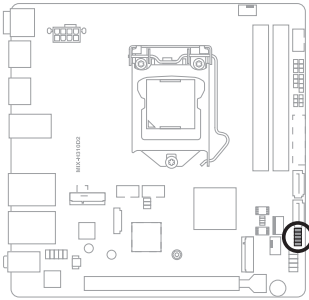

USB2_9

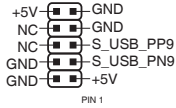

Never connect a 1394 cable to the USB header. Doing so will damage the motherboard.

8. M.2 E-Key and M-Key slots

These slots allow you to install M.2 (NGFF) modules.

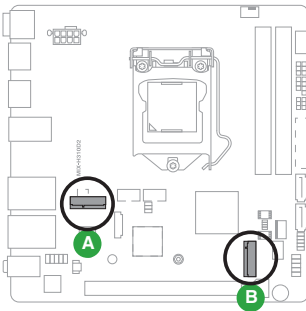

A M2_TYPE_E1



B M2_TYPE_M1



NOTES:

- The M.2 SSD module is purchased separately.
- The M.2 E-key slot supports type 2230 PCIe/CNV1 module.
- The M.2 M-key slot supports type 2242/2280 PCIe x 1 Gen2 storage devices.

9. System Panel header (10-1 pin F_PANEL)

This header supports several chassis-mounted functions.

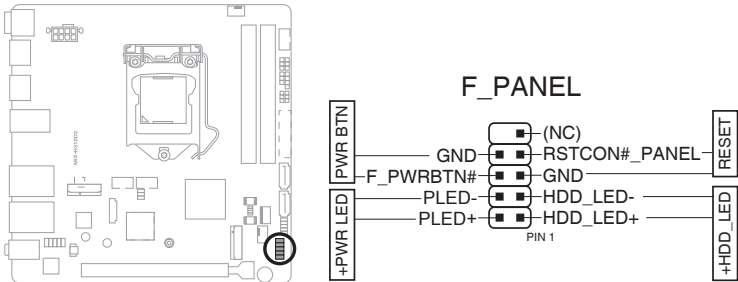

- **System power LED (2-pin +PWR_LED)**

This 2-pin header is for the system power LED. Connect the chassis power LED cable to this header. The system power LED lights up when you turn on the system power, and blinks when the system is in sleep mode.

- **Hard disk drive activity LED (2-pin +HDD_LED)**

This 2-pin header is for the HDD Activity LED. Connect the HDD Activity LED cable to this header. The IDE LED lights up or flashes when data is read from or written to the HDD.

- **ATX power button/soft-off button (2-pin PWR_BTN)**

This 2-pin header is for the system power button.

- **Reset button (2-pin RESET)**

This 2-pin header is for the chassis-mounted reset button for system reboot without turning off the system power.

10. BIOS programmable header (8-pin SPI_1)

Use this header to flash the BIOS ROM.

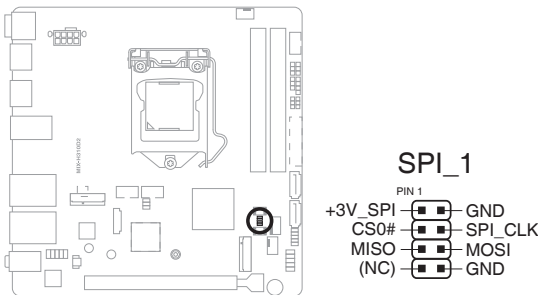

11. Battery connector (2-pin BATTERY_H)

This connector is for the lithium CMOS battery.

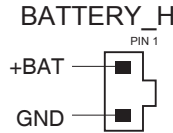
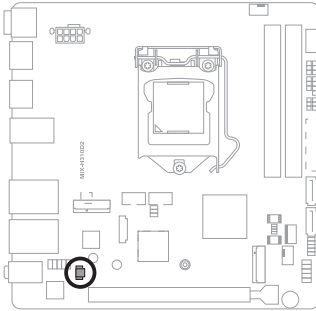

12. Front Panel Audio header (10-pin AAFP)

This header is for a chassis-mounted front panel audio I/O module that supports HD Audio audio standard. Connect one end of the front panel audio I/O module cable to this header.

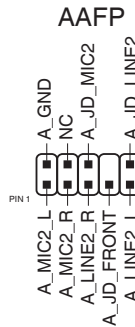
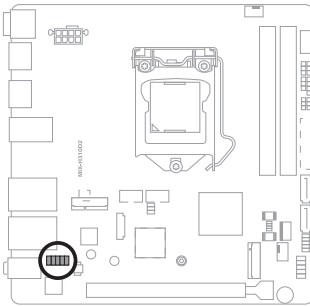

IMPORTANT: We recommend that you connect a high-definition front panel audio module to this header to avail of the motherboard's high-definition audio capability.

13. Debug Card connector

This connector allows connection to a Debug card.

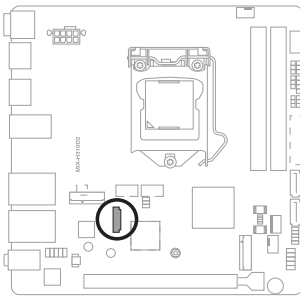

DEBUG

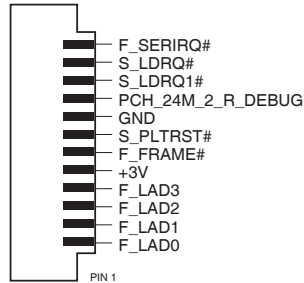

14. Serial Port headers (10-pin COM1~2)

These headers are for serial (COM) ports. Connect the serial port module cable to the header, then install the module to a slot opening at the back of the system chassis.

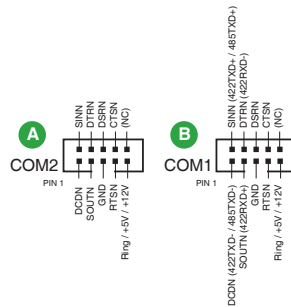
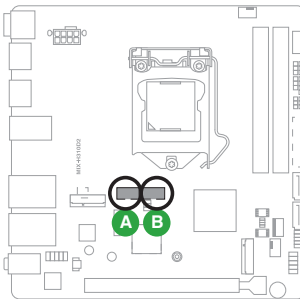

NOTE: The COM module is purchased separately.



Chapter 3

BIOS setup

3.1 BIOS setup

Use the BIOS Setup to configure settings. The BIOS screens include navigation keys and help to guide you in using the BIOS Setup program.

Entering BIOS Setup at startup

To enter BIOS Setup at startup:

Press <Delete> during the Power-On Self Test (POST). If you do not press <Delete>, POST continues with its routine.

Entering BIOS Setup after POST

To enter BIOS Setup after POST:

- Press <Ctrl>+<Alt>+ simultaneously.
- Press the reset button on the system chassis.
- Press the power button to turn the system off then back on. Do this option only if you failed to enter BIOS Setup using the first two options.



NOTE: Using the power button, reset button, or the <Ctrl>+<Alt>+ keys to reboot a running operating system can cause damage to your data or system. Always shut down the system properly from the operating system.



IMPORTANT:

- The default BIOS settings for this motherboard apply to most working conditions and ensures optimal performance. If the system becomes unstable after changing any BIOS settings, load the default settings to regain system stability. Select the option **Restore Defaults** under the Save & Exit Menu. See section **3.7 Save & Exit Menu**.
 - The BIOS setup items described in this section are for reference purposes only, and may not exactly match what you see on your screen.
-

Menu bar

The menu bar on top of the screen has the following main items:

Main	For changing the basic system configuration.
Advanced	For changing the advanced system settings.
Chipset	For viewing and changing chipset settings.
Security	For setting up BIOS security settings.
Boot	For changing the system boot configuration.
Save & Exit	For selecting the exit options and loading default settings.

To select an item on the menu bar, press the right or left arrow key on the keyboard until the desired item is highlighted.

3.2 Main menu

The Main menu provides you an overview of the basic system information, and allows you to set the system date, time, language, and security settings.

3.2.1 System Date [Day MM/DD/YYYY]

Allows you to set the system date.

3.2.2 System Time [HH:MM:SS]

Allows you to set the system time.

3.3 Advanced menu

The Advanced menu items allow you to change the settings for the CPU and other system devices.



Be cautious when changing the settings of the Advanced menu items. Incorrect field values can cause the system to malfunction.

Case Open Warning [Disabled]

Allows you to enable or disable case open warning function. Configuration options: [Disabled] [Enabled] [Clear]

3.3.1 CPU Configuration

The items in this menu show CPU-related information the BIOS automatically detects.



The items shown in the submenu may be different depending on the type of CPU installed.

Intel (VMX) Virtualization Technology [Enabled]

[Enabled] Allows a hardware platform to run multiple operating systems separately and simultaneously, enabling one system to virtually function as several systems.

[Disabled] Disables this function.

3.3.2 Trusted Computing

Security Device Support [Enable]

Allows you to enable or disable BIOS support for security devices. Configuration options: [Disable] [Enable]

Pending operation [None]

Allows you to schedule an operation for security devices. Reboot your system for the changes to take effect. Configuration options: [None] [TPM Clear]

Platform Hierarchy [Enabled]

Allows you to enable or disable Platform Hierarchy. Configuration options: [Enabled] [Disabled]

Storage Hierarchy [Enabled]

Allows you to enable or disable Storage Hierarchy. Configuration options: [Enabled] [Disabled]

Endorsement Hierarchy [Enabled]

Allows you to enable or disable Endorsement Hierarchy. Configuration options: [Enabled] [Disabled]

TPM2.0 UEFI Spec Version [TCG_2]

Allows you to select the TCG2 spec version support.

[TCG_1_2] Compatible mode for Windows® 8 / Windows® 10.

[TCG_2] Newer TCG2 protocol and event format for Windows® 10 or later.

Physical Presence Spec Version [1.3]

Allows you to select which TCG Physical Presence Interface Specification Version is supported by the OS. Configuration options: [1.2] [1.3]

Device Select [Auto]

Allows you to schedule an operation for security devices. Reboot your system for the changes to take effect. Configuration options: [Auto] [TPM 1.2] [TPM 2.0]

[Auto] Select this item to support both TPM 1.2 and TPM 2.0 devices with default support of TPM 2.0 devices. If TPM 2.0 devices are not found, TPM 1.2 devices will be enumerated.

3.3.3 SATA Configuration

SATA Controller(s) [Enabled]

Allows you to enable or disable SATA devices. Configuration options: [Enabled] [Disabled]

SATA Mode Selection [AHCI]

Allows you to set the working mode of the SATA controller. Configuration options: [AHCI] [RAID]

Port 0, Port 2 [Enabled]

These items allow you to enable/disable the SATA port(s). Configuration options: [Disabled] [Enabled]

Hot Plug [Disabled]

These items allow you to enable/disable SATA Hot Plug Support. Configuration options: [Disabled] [Enabled]

3.3.4 USB Configuration



The USB Devices item lists auto-detected values. If no USB device is detected, the item shows None.

Legacy USB Support [Enabled]

- | | |
|------------|---|
| [Enabled] | Enables the support for USB devices on legacy operating systems (OS). |
| [Disabled] | USB devices are only available when running BIOS Setup. |
| [Auto] | Allows the system to detect the presence of USB devices at startup. If detected, the USB controller legacy mode is enabled. If no USB device is detected, the legacy USB support is disabled. |

3.3.5 Hardware Monitor

The items in this menu allow you to configure the smart fan.

Smart Fan Configuration

CPU Smart Fan Control / CHA_FAN1 Smart Fan Control [Enabled]

Allows you to enable or disable CPU_FAN1/CHA_FAN1 Smart Fan Control. Configuration options: [Enabled] [Disabled]



The following sub-items appear only when you set **CPU Smart Fan Control** or **CHA_FAN1 Smart Fan Control** to [Enabled].

Fan Control Mode [Smart Fan IV Mode]

Configuration options: [Manual Mode] [Thermal Cruise Mode] [Smart Fan IV Mode]



The following items appear only when you set **Fan Control Mode** to [Smart Fan IV Mode].

**Temperature 1 [40] / Temperature 2 [50] / Temperature 3 [60] /
Temperature 4 [70]**

Sets the temperature value for the Smart Fan IV mode.

Fan PWM 1 [150] / Fan PWM 2 [170] / Fan PWM 3 [200] / Fan PWM 4 [220]

Sets the Fan PWM value for the Smart Fan IV mode.

Tolerance of Temperature [0]

Input value range: [0~7]

Critical Temperature [75]

Input value range: [0~255]

Critical Temp Tolerance [0]

Input value range: [0~7]

Fan Count Step Up [1]

Input value range: [0~15]

Fan Count Step Down [1]

Input value range: [0~15]

Fan Out Step Up Time [10]

Sets the amount of time Fan Out takes to increase its value by one step.

Input value range: [0~255]

Fan Out Step Down Time [10]

Sets the amount of time Fan Out takes to decrease its value by one step in intervals of 0.1 seconds. Input value range: [0~255]



The following item appears only when you set **Fan Control Mode** to [Manual Mode].

PWM/DC Voltage Output [255]

Sets the voltage allocated for Fan Control. Input value range: [0~255]



The following items appear only when you set **Fan Control Mode** to [Thermal Cruise Mode].

Target Temperature [50]

Input value range: [0~127]

Tolerance of Temperature [0]

Input value range: [0~7]

Fan Out Start-Up Value [127]

Input value range: [0~255]

Fan Stop Duty [Down to 0]

Configuration options: [Down to 0] [To Fan Out Stop Value]

Fan Out Stop Value [100]

The Fan Out value decreases to this value if the temperature reaches below the lowest temperature limit. Input value range: [0~255]

Fan Out Stop Time [60]

Determines the amount of time it takes for the Fan Out value to fall from the stop value to zero. Input value range: [0~255]

Critical Temperature [75]

Determines the amount of time Fan Out takes to decrease its value by one step. Input value range: [0~255]

Fan Out Step Up Time [10]

Determines the amount of time Fan Out takes to increase its value by one step. Input value range: [0~255]

Fan Out Step Down Time [10]

Determines the amount of time Fan Out takes to decrease its value by one step in intervals of 0.1 seconds. Input value range: [0~255]

3.3.6 SIO Configuration

The items in this menu allow you to configure Super IO settings.

[*Active*] Serial Port 1

Use this device [Enabled]

Allows you to enable or disable this logical device. Configuration options: [Enabled] [Disabled]



The following two items appear only when you set **Use this device** to [Enabled].

Possible [Use Automatic Settings]

Allows you to select an optimal setting for Super I/O devices. Configuration options: [Use Automatic Settings] [IO=3F8h; IRQ=4;] [IO=3E8h; IRQ=7]

Mode [RS232]

Allows you to select the Serial Port mode. Configuration options: [RS232] [RS422] [RS485]

[*Active*] Serial Port 2

Use this device [Enabled]

Allows you to enable or disable this logical device. Configuration options: [Enabled] [Disabled]



The following two items appear only when you set **Use this device** to [Enabled].

Possible [Use Automatic Settings]

Allows you to select an optimal setting for Super I/O devices. Configuration options: [Use Automatic Settings] [IO=3E8h; IRQ=7;] [IO=3F8h; IRQ=4]

3.3.7 AMT Configuration

AMT BIOS Features [Enabled]

When disabled, you are not able to access the MEBx setup. Configuration options: [Enabled] [Disabled]



This option does not disable manageability features in the firmware.

3.3.8 PCH-FW Configuration

Firmware Update Configuration

Me FW Image Re-Flash [Disabled]

This item allows you to enable or disable Me FW Image Re-Flash function. Configuration options: [Disabled] [Enabled]

3.3.9 Power Management

Power Mode [ATX Type]

Select power supply mode. Configuration options: [ATX Type] [AT Type]



The following items appear when you set Power Mode to [ATX Type].

Restore AC Power Loss [Last State]

[Last State] The system goes into either off or on state, whatever the system state was.

[Always On] The system goes into on state after an AC power loss.

[Always Off] The system goes into off state after an AC power loss.

RI Wake Event [Disabled]

Enable or disable system to wake up from RI#. Configuration options: [Enabled] [Disabled]

RTC Wake system from S5 [Disabled]

[Disabled] Disables system wake up from S5.

[Fixed Time] The system will wake up at the specified hr::min::sec. Configuration options: [Disabled] [Enabled] .

[Dynamic Time] The system will wake up at the current time plus a specified number of minutes.



The following items appear when Fixed Time is enabled.

Wake up day/hour/minute/second [0]

Specify the values for day/hour/minute/second.



The following item appears when Wake System with Dynamic Time is enabled.

Wake up minute increase [1]

Specify the number of minutes added to the current time before waking up system. Input value range: [1~5]

3.3.10 Digital IO Port Configuration

The items listed in this screen configure Digital IO settings.

DIO Port1~Port4 [Output], DIO Port5~Port8 [Input]

Configuration options: [Input] [Output]



The following item appears only when you set **DIO Port1~8** to [Output].

Output Level [High]

Configuration options: [High] [Low]

3.4 Chipset menu

The Chipset menu items allow you to change configuration options for the North Bridge and South Bridge.

3.4.1 System Agent (SA) Configuration

Primary Display [Auto]

Allows you to decide which graphics controller to use as the primary boot device. Configuration options: [Auto] [IGFX] [PEG]

Primary IGFX Boot Display [VBIOS Default]

Select the video device which will be activated during POST. This setting has no effect if an external graphics device is present. The secondary boot display selection appears based on your selection and the VGA mode is supported only on primary display. Configuration options: [VBIOS Default] [eDP] [VGA] [HDMI1] [HDMI2]

PCIEX16 Gen Speed [Auto]

Allows you to select the PCI Express port speed. Configuration options: [Auto] [Gen1] [Gen2] [Gen 3]

3.4.2 PCH-IO Configuration

HD Audio [Enabled]

This item controls the detection of HD Audio devices. Configuration options: [Disabled] [Enabled]

3.5 Security menu

The Security menu items allow you to change the system security settings.

3.5.1 Administrator Password

If you have set an administrator password, we recommend that you enter the administrator password for accessing the system. Otherwise, you might be able to see or change only selected fields in the BIOS setup program.

To set an administrator password:

1. Select the Administrator Password item and press <Enter>.
2. From the Create New Password box, key in a password, then press <Enter>.
3. Confirm the password when prompted.

To change an administrator password:

1. Select the Administrator Password item and press <Enter>.
2. From the Enter Current Password box, key in the current password, then press <Enter>.
3. From the Create New Password box, key in a new password, then press <Enter>.
4. Confirm the password when prompted.

To clear the administrator password, follow the same steps as in changing an administrator password, but press <Enter> when prompted to create/confirm the password. After you clear the password, the Administrator Password item on top of the screen shows Not Installed.

3.5.2 User Password

If you have set a user password, you must enter the user password for accessing the system. The User Password item on top of the screen shows the default Not Installed. After you set a password, this item shows Installed.

To set a user password:

1. Select the User Password item and press <Enter>.
2. From the Create New Password box, key in a password, then press <Enter>.
3. Confirm the password when prompted.

To change a user password:

1. Select the User Password item and press <Enter>.
2. From the Enter Current Password box, key in the current password, then press <Enter>.
3. From the Create New Password box, key in a new password, then press <Enter>.
4. Confirm the password when prompted.

To clear the user password, follow the same steps as in changing a user password, but press <Enter> when prompted to create/confirm the password. After you clear the password, the **User Password** item on top of the screen shows **Not Installed**.

3.6 Boot menu

The Boot menu items allow you to change the system boot options.

3.6.1 Boot Configuration

Quiet Boot [Enabled]

This item enables/disables Quiet Boot. Configuration options: [Disabled] [Enabled]

Launch PXE ROM [Do not launch]

This item controls the execution of UEFI and Legacy PXE OpROM. Configuration options: [Do not launch] [Legacy]

3.6.2 FIXED BOOT ORDER Priorities

Boot Option #1-#16

This item allows you to set the system boot order. Configuration options: [UEFI USB Key] [UEFI Hard Disk] [UEFI USB Hard Disk] [UEFI Network] [UEFI USB Lan] [UEFI CD/DVD] [UEFI USB CD/DVD] [UEFI USB Floppy] [USB Key] [Hard Disk] [USB Hard Disk] [Network] [USB Lan] [CD/DVD] [USB CD/DVD] [USB Floppy] [Disabled]

3.7 Save & Exit menu

Save Changes and Reset

Once you are finished making your selections, choose this option from the Save & Exit menu to ensure the values you selected are saved. When you select this option, a confirmation window appears. Select Yes to save changes and reset.

Discard Changes and Exit

This option allows you to exit the Setup program without saving your changes. When you select this option or if you press <Esc>, a confirmation window appears. Select Yes to discard changes and exit.

Restore Defaults

Save or restore User Defaults to all setup options.

Appendix

Notices

Federal Communications Commission Statement

This device complies with Part 15 of the FCC Rules. Operation is subject to the following two conditions:

- This device may not cause harmful interference.
- This device must accept any interference received including interference that may cause undesired operation.

This equipment has been tested and found to comply with the limits for a Class A digital device, pursuant to Part 15 of the FCC Rules. These limits are designed to provide reasonable protection against harmful interference in a residential installation. This equipment generates, uses and can radiate radio frequency energy and, if not installed and used in accordance with manufacturer's instructions, may cause harmful interference to radio communications. However, there is no guarantee that interference will not occur in a particular installation. If this equipment does cause harmful interference to radio or television reception, which can be determined by turning the equipment off and on, the user is encouraged to try to correct the interference by one or more of the following measures:

- Reorient or relocate the receiving antenna.
- Increase the separation between the equipment and receiver.
- Connect the equipment to an outlet on a circuit different from that to which the receiver is connected.
- Consult the dealer or an experienced radio/TV technician for help.



WARNING! The use of shielded cables for connection of the monitor to the graphics card is required to assure compliance with FCC regulations. Changes or modifications to this unit not expressly approved by the party responsible for compliance could void the user's authority to operate this equipment.



DO NOT throw the motherboard in municipal waste. This product has been designed to enable proper reuse of parts and recycling. This symbol of the crossed out wheeled bin indicates that the product (electrical and electronic equipment) should not be placed in municipal waste. Check local regulations for disposal of electronic products.



DO NOT throw the mercury-containing button cell battery in municipal waste. This symbol of the crossed out wheeled bin indicates that the battery should not be placed in municipal waste.

HDMI Trademark Notice

The terms HDMI, HDMI High-Definition Multimedia Interface, HDMI trade dress and the HDMI Logos are trademarks or registered trademarks of HDMI Licensing



电子电气产品有害物质限制使用标识要求：图中之数字为产品之环保使用期限。仅指电子电气产品中含有的有害物质不致发生外泄或突变从而对环境造成污染或对人身、财产造成严重损害的期限。

部件名称	有害物质					
	铅 (Pb)	汞 (Hg)	镉 (Cd)	六价铬 (Cr(VI))	多溴联苯 (PBB)	多溴二苯醚 (PBDE)
印刷电路板及其电子组件	×	○	○	○	○	○
外壳	×	○	○	○	○	○
电源适配器	×	○	○	○	○	○
外部信号连接头及线材	×	○	○	○	○	○
中央处理器与内存	×	○	○	○	○	○

本表格依据 SJ/T 11364 的规定编制。

○：表示该有害物质在该部件所有均质材料中的含量均在 GB/T 26572 规定的限量要求以下。

×：表示该有害物质至少在该部件的某一均质材料中的含量超出 GB/T 26572 规定的限量要求，然该部件仍符合欧盟指令 2011/65/EU 的规范。

备注：此产品所标示之环保使用期限，系指在一般正常使用状况下。