

**MAX-H310A**

**Industrial Motherboard**

E15284  
First Edition  
May 2019

### **Copyright Notice**

This document is copyrighted, 2019. All rights are reserved. The original manufacturer reserves the right to make improvements to the products described in this manual at any time without notice.

No part of this manual may be reproduced, copied, translated, or transmitted in any form or by any means without the prior written permission of the original manufacturer. Information provided in this manual is intended to be accurate and reliable. However, the original manufacturer assumes no responsibility for its use, or for any infringements upon the rights of third parties that may result from its use. The material in this document is for product information only and is subject to change without notice. While reasonable efforts have been made in the preparation of this document to assure its accuracy, the original manufacturer assumes no liabilities resulting from errors or omissions in this document, or from the use of the information contained herein.

The original manufacturer reserves the right to make changes in the product design without notice to its users.

### **Acknowledgments**

All other products' name or trademarks are properties of their respective owners.

- AMI is a trademark of American Megatrends Inc.
- Intel®, Core™ are trademarks of Intel® Corporation.
- Microsoft Windows® is a registered trademark of Microsoft Corp.
- IBM, PC/AT, PS/2, and VGA are trademarks of International Business Machines Corporation.

The original manufacturer reserves the right to make changes in the product design without notice to its users.

All other product names or trademarks are properties of their respective owners.

## Contents

<b>Chapter 1</b>	<b>Product overview</b>	<b>1-1</b>
1.1	Package contents.....	1-1
1.2	Features .....	1-1
1.3	Specifications.....	1-2
<b>Chapter 2</b>	<b>Motherboard information</b>	<b>2-1</b>
2.1	Before you proceed .....	2-1
2.2	Motherboard layout.....	2-2
2.3	Screw size.....	2-4
	2.3.1 Component side.....	2-4
	2.3.2 Solder side .....	2-5
2.4	Central Processing Unit (CPU) .....	2-6
	2.4.1 Installing the CPU .....	2-7
	2.4.2 CPU heatsink and fan assembly installation.....	2-8
2.5	System memory .....	2-10
	2.5.1 Installing a DIMM .....	2-10
2.6	Jumpers .....	2-12
2.7	Connectors .....	2-16
	2.7.1 Rear panel connectors.....	2-16
	2.7.2 Internal connectors .....	2-18
<b>Chapter 3</b>	<b>BIOS setup</b>	<b>3-1</b>
3.1	BIOS setup program .....	3-1
	3.1.1 BIOS menu screen.....	3-2
	3.1.2 Menu bar .....	3-2
3.2	Main menu .....	3-2
	3.2.1 System Date [Day MM/DD/YYYY] .....	3-2
	3.2.2 System Time [HH:MM:SS].....	3-2
3.3	Advanced menu .....	3-3
	3.3.1 CPU Configuration .....	3-3
	3.3.2 Trusted Computing .....	3-3
	3.3.3 SATA Configuration .....	3-5
	3.3.4 USB Configuration .....	3-5
	3.3.5 Hardware Monitor .....	3-6
	3.3.6 SIO Configuration .....	3-10

**Contents**

- 3.3.7 PCH-FW Configuration ..... 3-12
- 3.3.8 Power Management..... 3-12
- 3.3.9 Digital IO Port Configuration ..... 3-13
- 3.4 Chipset menu ..... 3-13**
  - 3.4.1 System Agent (SA) Configuration ..... 3-13
  - 3.4.2 PCH-IO Configuration ..... 3-14
- 3.5 Security menu ..... 3-14**
  - 3.5.1 Administrator Password ..... 3-14
  - 3.5.2 User Password..... 3-15
- 3.6 Boot menu ..... 3-16**
  - 3.6.1 Boot Configuration ..... 3-16
- 3.7 Save & Exit menu ..... 3-16**

**Appendix**

**Notices.....A-1**

# Chapter 1

## Product overview

### 1.1 Package contents

Check your industrial motherboard package for the following items.

- 1 x Industrial Motherboard
- 1 x SATA Cable
- 1 x I/O Shield
- 1 x Support DVD
- 1 x COM port cable



---

If any of the above items is damaged or missing, contact your distributor or sales representative immediately.

---

### 1.2 Features

- Intel® 8<sup>th</sup> Generation(Coffee Lake-S) Core™ i7/ i5 /i3, Pentium 14nm LGA 1151 socket Processor, 65W
- Two DDR4 (2666/2400/2133 MHz, max. 32GB) non-ECC, un-buffered memory
- SATAIII 6.0 Gb/s port x 3 (BOM option: additional 2 SATA), M.2 2280 M-key (SATA3+PCIex1) x 1
- PCI-Express 3.0 slot [x16] x 1, PCI-Express 2.0 slot [x1] x 3, M.2 2280 M-key for PCIe/SATA (BOM option: default SATA) x 1
- VGA, HDMI and DisplayPort support

## 1.3 Specifications

SYSTEM	
Form factor	Micro-ATX Form Factor, 9.6"x9.6" (244mmx244mm)
CPU	Intel® 8 <sup>th</sup> Generation (Coffee Lake-S) Core™ i7/ i5 /i3, Pentium 14nm LGA 1151 socket Processor, 65W
Memory	2 x DIMM, DDR4 (2666/2400/2133 MHz, max. 32GB), non-ECC, un-buffered memory Dual-channel memory architecture
I/O Chipset	NCT6793D+ F81216HD
Ethernet	1 x Intel® PHY i219V Giga LAN 1 x Intel® i211AT Giga LAN 2 x RJ45 ports
BIOS	1 x 128Mbit Flash ROM, AMI BIOS
Wake on LAN	Yes (WOL/PXE)
Watchdog Timer	1~255 steps by software program
H/W Monitor	Temperature Monitor on CPU/Chassis Voltage Monitor on Vcore/5V/3.3V/12V Fan Monitor on CPU/Chassis
Smart Fan Control	CPU Fan x1 / Chassis Fan x 2
Power State	S3, S4, S5
Expansion slot	1 x PCIe 3.0[x16] Slot 3x PCIe 2.0[x1] Slot (open edge) 1 x M.2 2280 M-key for PCIe/SATA (BOM option: default SATA)
TPM	Nuvoton NPCT650ABBYX TPM2.0 onboard (option)
Battery	Lithium battery
Power requirement	1 x 24-pin ATX connector 1 x 8-pin (2x4) ATX 12V Power connector
Board size	9.6" x 9.6" (244mm x 244mm)
Gross weight	1.76 lb (0.8 Kg)
Operating temperature	32~140°F (0~60°C)
Storage temperature	-40°F ~185°F (-40°C ~85°C)
Operating humidity	0%~90% relative humidity, non-condensing
Power compliance	N/A
Certificate	CE/FCC

(continued on the next page)

<b>DISPLAY</b>	
<b>Chipset</b>	Intel® Graphics Media Accelerator
<b>Output</b>	<b>DisplayPort:</b> Up to 4096 x 2160 @ 24 Hz / 3840 x 2160 @ 60 Hz, with Digital Audio <b>HDMI:</b> Up to 4096 x 2160 @ 24 Hz / 2560 x 1600 @ 60 Hz, with Digital Audio <b>VGA:</b> Up to 1920 x 1200 @60Hz (via IT6516B)
<b>I/O</b>	
<b>Storage</b>	3 x SATA III (6.0Gb/s) ports (BOM option: additional 2 SATA) 1 x M.2 2280 M-key (SATA3 + PCIe x 1)
<b>Serial port</b>	5 x RS-232 headers 1 x RS-232/422/485 (COM1, supports 5V/12V/RI optional)
<b>USB</b>	1 x USB 2.0 header supports additional 2 USB ports (2x5PIN, p=2.54mm) 4 x USB 3.1 Gen1 ports (5 Gbps) on rear I/O 4 x USB 2.0 ports on rear I/O
<b>Fan</b>	1 x CPU Fan connector (4-pin) 2 x Chassis Fan connector(s) (4-pin)
<b>DIO</b>	1 x 8-bit Digital I/O interface (In/Out programmable)
<b>Keyboard/Mouse</b>	1 x PS/2 stack Port (Keyboard & Mouse)
<b>Audio</b>	1 x speaker header (Line-out) 3 x Audio Jacks: Line-in, Mic-in, and Line-out on rear I/O
<b>Ethernet</b>	2 x RJ-45 ports on rear I/O
<b>Display</b>	1 x VGA port on rear I/O 1 x HDMI port on rear I/O 1 x DisplayPort port on rear I/O
<b>Others</b>	1 x Chassis Intrusion 1 x AT/ATX mode select jumper 1 x Front panel header 1 x Clear CMOS jumper 1 x LPC BOX header

# Chapter 2

## Motherboard information

### 2.1 Before you proceed

Take note of the following precautions before you install motherboard components or change any motherboard settings.



---

**CAUTION!**

- Unplug the power cord from the wall socket before touching any component.
  - Before handling components, use a grounded wrist strap or touch a safely grounded object or a metal object, such as the power supply case, to avoid damaging them due to static electricity.
  - Hold components by the edges to avoid touching the ICs on them.
  - Whenever you uninstall any component, place it on a grounded antistatic pad or in the bag that came with the component.
  - Before you install or remove any component, ensure that the ATX power supply is switched off or the power cord is detached from the power supply. Failure to do so may cause severe damage to the motherboard, peripherals, or components.
-



## 2.2 Motherboard layout



**NOTE:** Place eight screws into the holes indicated by circles to secure the motherboard to the chassis.



**CAUTION!** Do not overtighten the screws! Doing so can damage the motherboard.

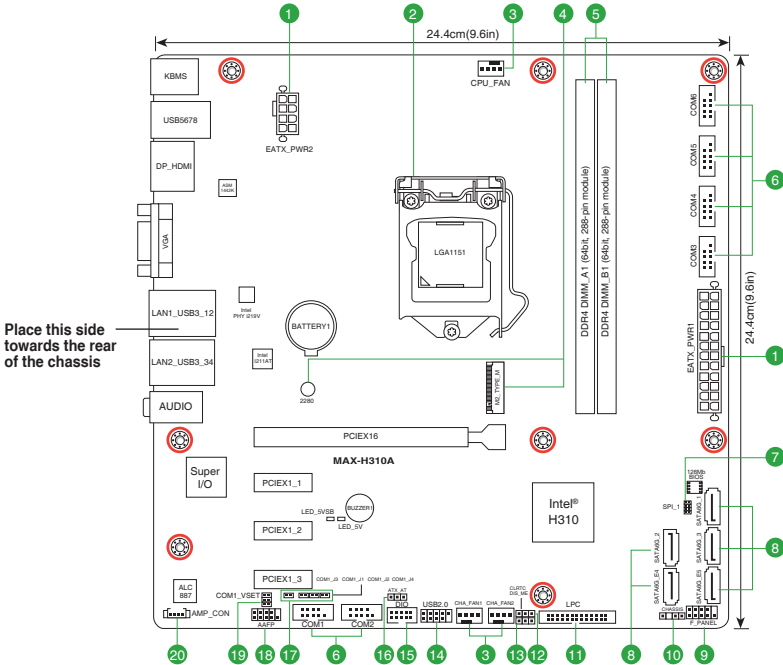

Connectors/Jumpers/Slots	Page
1. ATX power connectors (24-pin EATX_PWR1, 8-pin EATX_PWR2)	2-18
2. Intel® LGA1151 CPU socket	2-6
3. CPU and chassis fan connectors (4-pin CPU_FAN, 4-pin CHA_FAN1~2)	2-19
4. M.2 M-Key slot	2-21
5. DDR4 DIMM slots	2-10
6. Serial port connectors (10-1 pin COM1~6)	2-22
7. BIOS programmable connector (8-pin SPI_1)	2-18
8. Serial ATA 6.0Gb/s connectors (7-pin SATA6G_1~3, SATA6G_E4/E5)	2-21
9. System panel connector (10-1 pin F_PANEL)	2-20
10. Chassis intrusion connector (4-1 pin CHASSIS)	2-14
11. LPC Box header (26-pin LPC)	2-24
12. Clear RTC RAM (CLRTC)	2-12
13. Intel® ME Jumper (3-pin DIS_ME)	2-15
14. USB 2.0 connector (10-1 pin USB2.0)	2-23
15. Digital I/O connector (10-pin DIO)	2-24
16. AT/ATX mode jumper (3-pin ATX_AT)	2-13
17. COM1 RS422/RS485 terminator (2-pin COM1_J1~4)	2-13
18. Front panel audio connector (10-1 pin AAFP)	2-19
19. COM1 Ring/+5V/+12V selection (COM1_VSET)	2-14
20. Audio amplifier connector (4-pin AMP_CON)	2-23



## 2.3.2 Solder side

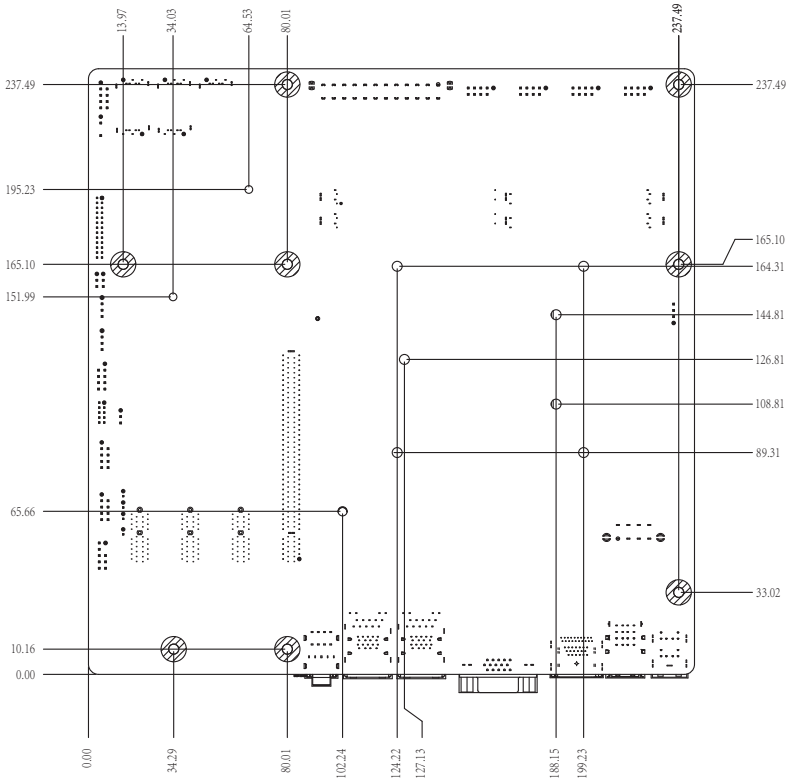

## 2.4 Central Processing Unit (CPU)

The motherboard comes with a surface mount LGA1151 socket designed for the Intel® 8th Generation(Coffee Lake-S) Core™ i7/ i5 /i3, Pentium 14nm LGA 1151 socket Processor.

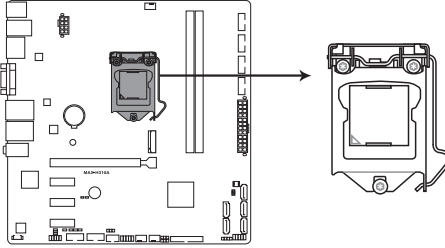

**MAX-H310A CPU socket LGA1151**



---

**IMPORTANT:** Unplug all power cables before installing the CPU.

---



### **CAUTION!**

- Upon purchase of the motherboard, ensure that the PnP cap is on the socket and the socket contacts are not bent. Contact your retailer immediately if the PnP cap is missing, or if you see any damage to the PnP cap/socket contacts/motherboard components. The manufacturer will shoulder the cost of repair only if the damage is shipment/transit-related.
  - Keep the cap after installing the motherboard. The manufacturer will process Return Merchandise Authorization (RMA) requests only if the motherboard comes with the cap on the LGA1151 socket.
  - The product warranty does not cover damage to the socket contacts resulting from incorrect CPU installation/removal, or misplacement/loss/incorrect removal of the PnP cap.
-

## 2.4.1 Installing the CPU



**CAUTION!** Ensure that you install the correct CPU designed for LGA 1151 only. DO NOT install a CPU designed for LGA1155 and LGA1156 sockets on the LGA1151 socket.

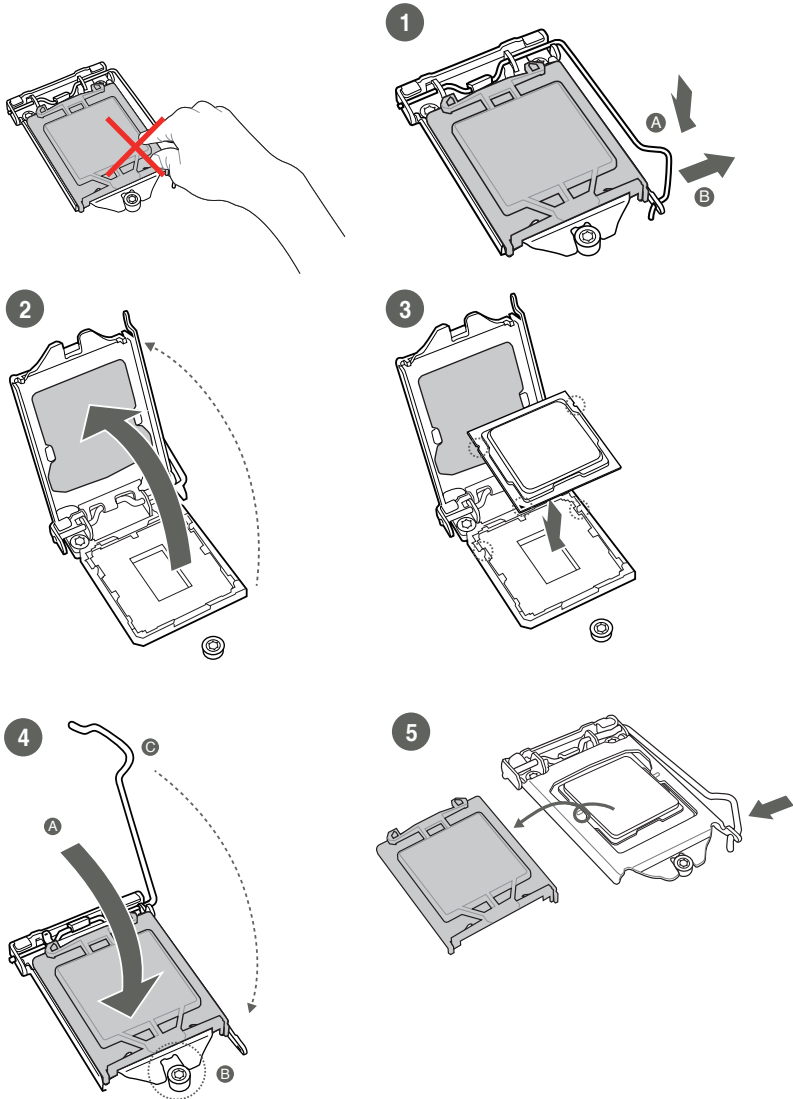

## 2.4.2 CPU heatsink and fan assembly installation

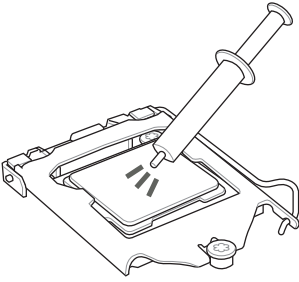

**CAUTION!** Apply the Thermal Interface Material to the CPU heatsink and CPU before you install the heatsink and fan if necessary.

### To install the CPU heatsink and fan assembly

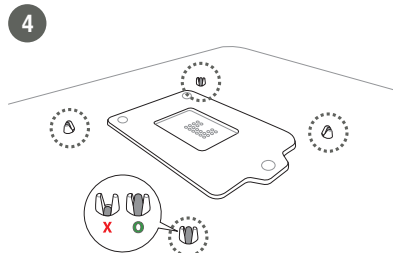
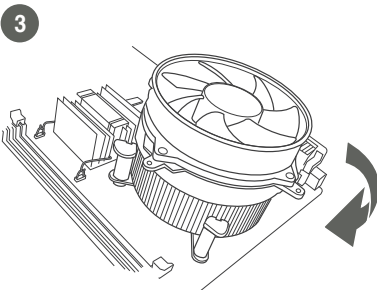
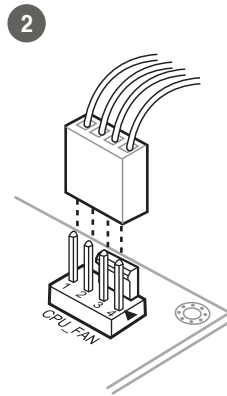
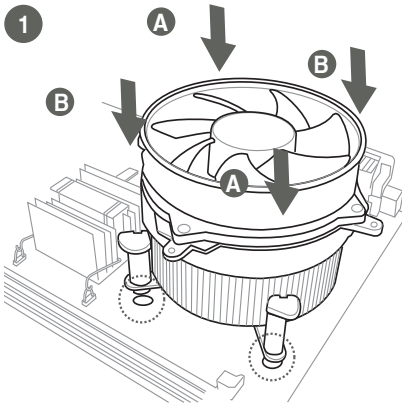

## To uninstall the CPU heatsink and fan assembly

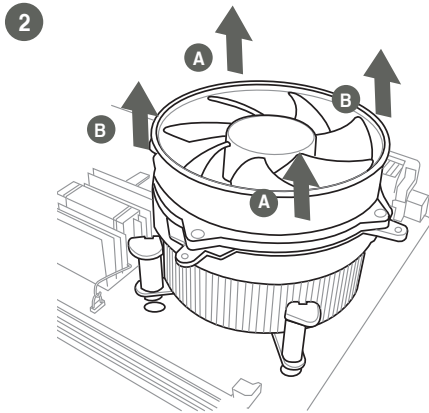
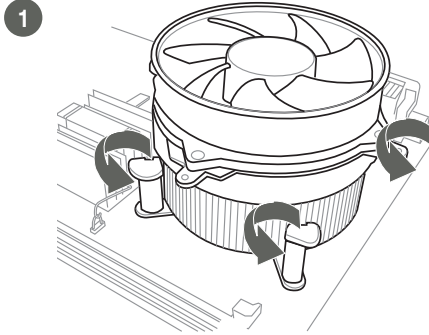



## 2.5 System memory

This motherboard comes with two Double Data Rate 4 (DDR4) Dual Inline Memory Module (DIMM) sockets. A DDR4 module is notched differently from a DDR, DDR2, or DDR3 module. DO NOT install a DDR, DDR2, or DDR3 memory module to the DDR4 slot.



According to Intel® CPU spec, DIMM voltage below 1.2 V is recommended to protect the CPU.

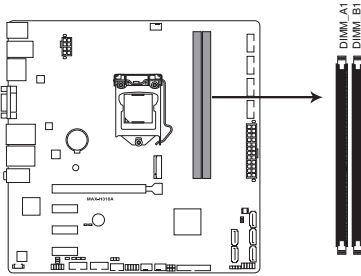

**MAX-H310A 288-pin DDR4 DIMM sockets**

### 2.5.1 Installing a DIMM

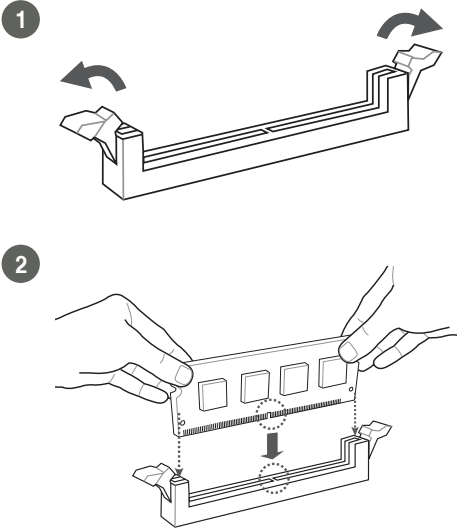

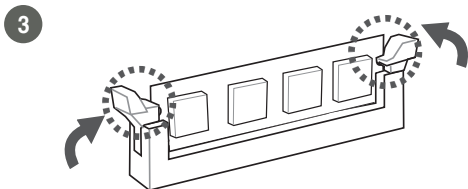

**To remove a DIMM**

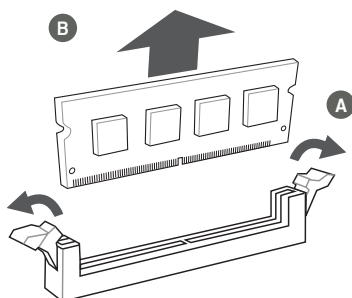

## 2.6 Jumpers

### 1. Clear RTC RAM (CLRRTC)

This jumper allows you to clear the Real Time Clock (RTC) RAM in CMOS. You can clear the CMOS memory of date, time, and system setup parameters by erasing the CMOS RTC RAM data. The onboard button cell battery powers the RAM data in CMOS, which include system setup information such as system passwords.

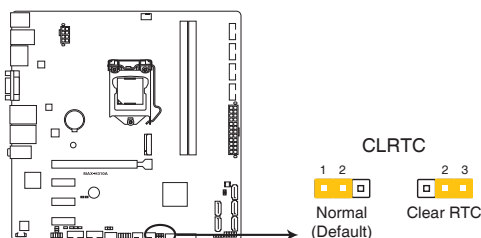

**MAX-H310A Clear RTC RAM**

#### To erase the RTC RAM:

1. Turn OFF the computer and unplug the power cord.
2. Move the jumper cap from pins 1-2 (default) to pins 2-3. Keep the cap on pins 2-3 for about 5~10 seconds, then move the cap back to pins 1-2.
3. Plug the power cord and turn ON the computer.
4. Hold down the <Del> key during the boot process and enter BIOS setup to reenter data.



---

**CAUTION!** Except when clearing the RTC RAM, never remove the cap on CLRRTC jumper default position. Removing the cap will cause system boot failure!

---



---

**NOTE:** If the steps above do not help, remove the onboard battery and move the jumper again to clear the CMOS RTC RAM data. After clearing the CMOS, reinstall the battery.

---

## 2. COM1 RS422/RS485 terminator (2-pin COM1\_J1~4)

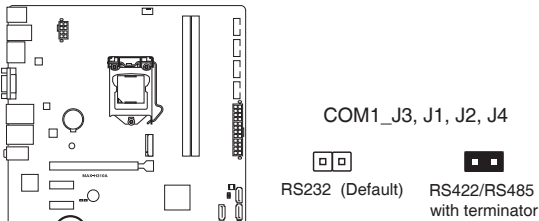

**MAX-H310A COM1 RS422/RS485 Terminator (J1/J2/J3/J4)**

## 3. AT/ATX Mode selection (3-pin ATX\_AT)

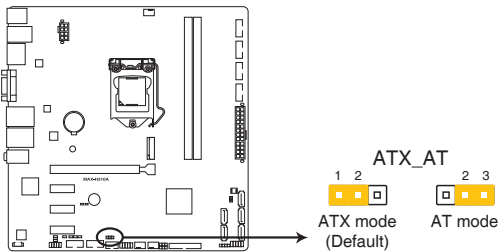

**MAX-H310A H/W AT/ATX mode selection**

Pins	
1-2 (Default)	ATX mode
2-3	AT mode



**NOTE:** Jumper setting of **ATX\_AT** should be consistent with the setting of **Power Mode** in BIOS. Refer to section **3.3.8 Power Management** in Chapter 3.

#### 4. Chassis intrusion connector (4-1 pin CHASSIS)

This connector is for a chassis-mounted intrusion detection sensor or switch. Connect one end of the chassis intrusion sensor or switch cable to this connector. The chassis intrusion sensor or switch sends a high-level signal to this connector when a chassis component is removed or replaced. The signal is then generated as a chassis intrusion event.

By default, the pin labeled “Chassis Signal” and “Ground” are shorted with a jumper cap. Remove the jumper caps only when you intend to use the chassis intrusion detection feature.

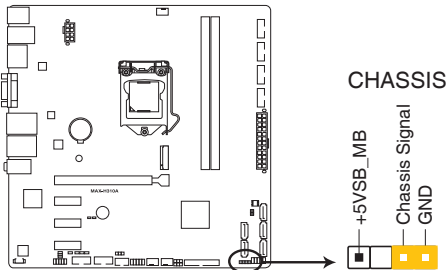

**MAX-H310A Chassis intrusion connector**

#### 5. COM1 Ring/+5V/+12V selector (6-pin COM1\_VSET)

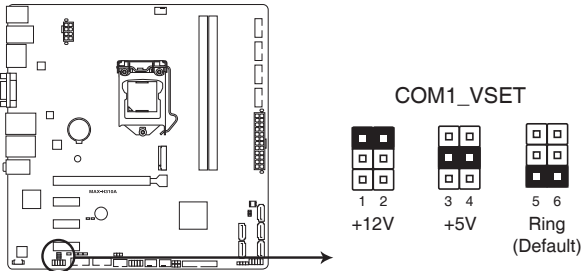

**MAX-H310A COM1 Ring/+5V/+12V Selection**

Setting	Pins
+12V	1-2
+5V	3-4
Ring (Default)	5-6

## 6. Intel® ME Jumper (3-pin DIS\_ME)

This jumper allows you to force the Intel® Management Engine (ME) to boot from recovery mode when ME becomes corrupted.

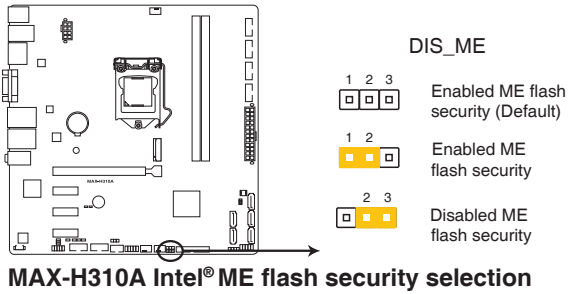

## 2.7 Connectors

### 2.7.1 Rear panel connectors

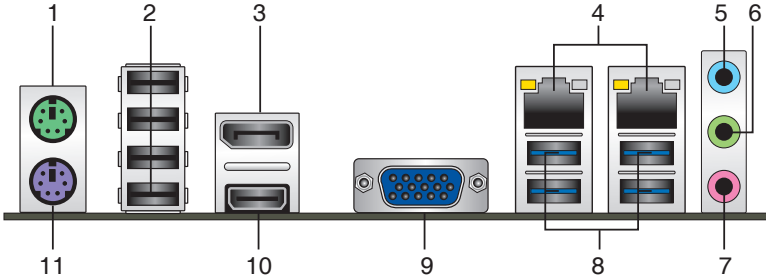

1. **PS/2 Mouse port (green).** This port is for a PS/2 mouse.
2. **USB 2.0 ports.** These two 4-pin Universal Serial Bus (USB) ports are available for connecting USB 2.0/1.1 devices.
3. **DisplayPort.** This port is for a DisplayPort-compatible devices.
4. **LAN1~2 (RJ-45) ports.** These ports allow Gigabit connection to a Local Area Network (LAN) through a network hub. Refer to the table below for the LAN port LED indications.

#### LAN port LED indications

ACT/LINK LED		SPEED LED	
Status	Description	Status	Description
OFF	No link	OFF	10 Mbps connection
ORANGE	Linked	ORANGE	100 Mbps connection
BLINKING	Data activity	GREEN	1 Gbps connection

Activity Link LED      Speed LED



LAN port

5. **Line In port (light blue).** This port connects to the tape, CD, DVD player, or other audio sources.
6. **Line Out port (lime).** This port connects to a headphone or a speaker.
7. **Microphone port (pink).** This port connects to a microphone.

8. **USB 3.1 Gen 1 ports (Blue, Type-A).** These 9-pin Universal Serial Bus (USB) ports are for USB 3.1 Gen 1 devices.



---

**NOTES:**

- We strongly recommend that you connect USB 3.1 Gen 1 devices to USB 3.1 Gen 1 ports for faster and better performance from your USB 3.1 Gen 1 devices.
- Due to the design of the Intel® 300 series chipset, all USB devices connected to the USB 2.0 and USB 3.1 Gen 1 ports are controlled by the xHCI controller. Some legacy USB devices must update their firmware for better compatibility.

- 
9. **Video Graphics Adapter (VGA) port.** This 15-pin port is for a VGA monitor or other VGA-compatible devices.



---

**NOTE:** Disable LVDS support when using only the VGA port. Refer to the section on System Agent (SA) Configuration in Chapter 3 for details.

---

10. **HDMI port.** This port is for a High-Definition Multimedia Interface (HDMI) connector, and is HDCP compliant allowing playback of HD DVD, Blu-ray, and other protected content.
11. **PS/2 Keyboard port (purple).** This port is for a PS/2 keyboard.



## 2.7.2 Internal connectors

### 1. ATX power connectors (24-pin EATX\_PWR1, 8-pin EATX\_PWR2)

These connectors are for ATX power supply plugs. The power supply plugs are designed to fit these connectors in only one orientation. Find the proper orientation and push down firmly until the connectors completely fit.

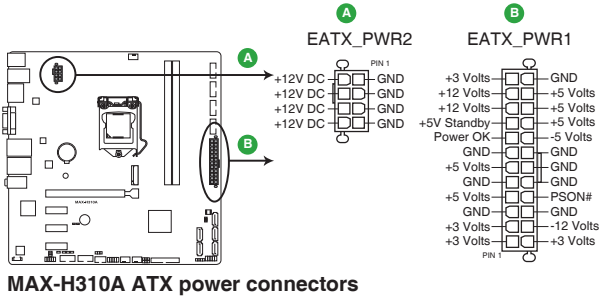

**MAX-H310A ATX power connectors**



**IMPORTANT:**

- For a fully configured system, we recommend that you use a power supply unit (PSU) that complies with ATX 12 V Specification 2.0 (or later version) and provides a minimum power of 330W.
- We recommend that you use a PSU with higher power output when configuring a system with more power-consuming devices. The system may become unstable or may not boot up if the power is inadequate.

### 2. BIOS programmable connector (8-pin SPI\_1)

Use this connector to flash the BIOS ROM.

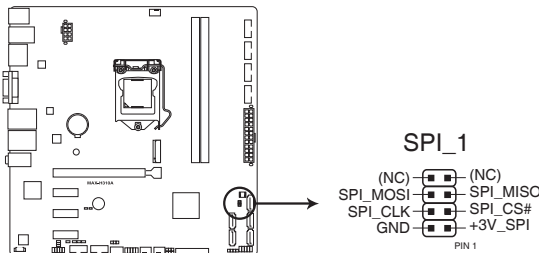

**MAX-H310A BIOS Programmable connector**

### 3. Front panel audio connector (10-1 pin AAFP)

This connector is for a chassis-mounted front panel audio I/O module that supports HD Audio standard. Connect one end of the front panel audio I/O module cable to this connector.

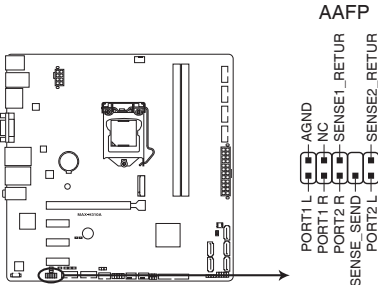

**MAX-H310A Front panel audio connector**



**IMPORTANT:** We recommend that you connect a high-definition front panel audio module to this connector to avail of the motherboard's high-definition audio capability.

### 4. CPU and chassis fan connectors (4-pin CPU\_FAN, 4-pin CHA\_FAN1~2)

Connect the fan cables to the fan connectors on the motherboard, ensuring that the black wire of each cable matches the ground pin of the connector.

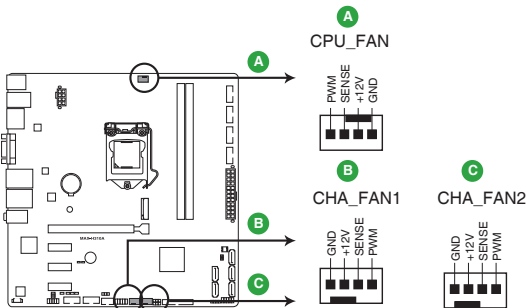

**MAX-H310A Fan connectors**



**CAUTION:** Do not forget to connect the fan cables to the fan connectors. Insufficient air flow inside the system may damage the motherboard components. These are not jumpers! Do not place jumper caps on the fan connectors!

## 5. System panel connector (10-1 pin F\_PANEL)

This connector supports several chassis-mounted functions.

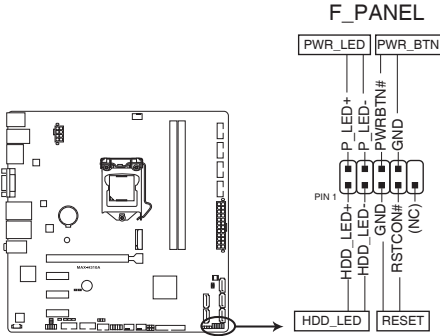

**MAX-H310A Front panel connector**

- **System power LED (2-pin PWR\_LED)**

This 2-pin connector is for the system power LED. Connect the chassis power LED cable to this connector. The system power LED lights up when you turn on the system power, and turns off when the system is in ACPI-S3/S4/S5 mode by default.

- **Hard disk drive activity LED (2-pin HDD\_LED)**

This 2-pin connector is for the HDD Activity LED. Connect the HDD Activity LED cable to this connector. The HDD LED lights up or flashes when data is read from or written to the HDD.

- **ATX power button/soft-off button (2-pin PWR\_BTN)**

This 2-pin connector is for the system power button. Pressing the power button turns the system on, puts the system in sleep, or soft-off mode depending on the operating system setting. Pressing the power switch for more than four seconds while the system is ON turns the system OFF.

- **Reset button (2-pin RESET)**

This 2-pin connector is for the chassis-mounted reset button for system reboot without turning off the system power.

## 6. Serial ATA 6.0Gb/s connector (7-pin SATA6G\_1~3, SATA6G\_E4/E5)

These connectors connect to Serial ATA 6.0 Gb/s hard disk drives via Serial ATA 6.0 Gb/s signal cables.

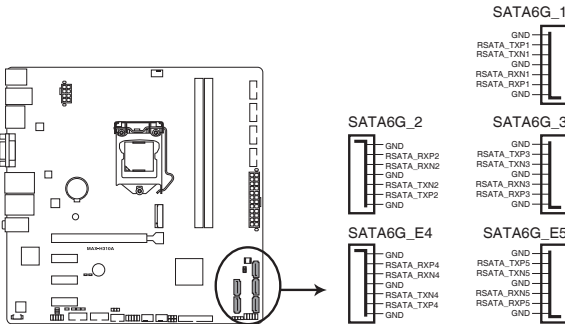

**MAX-H310A Intel® SATA 6 Gb/s connectors**



**NOTE:** When using hot-plug and NCQ, set the SATA Mode Selection item in the BIOS to [AHCI]. See section 3.3.3 **SATA Configuration** for details.

## 7. M.2 M-key 2280 socket

This socket allows you to install an M.2 (NGFF) SSD module.

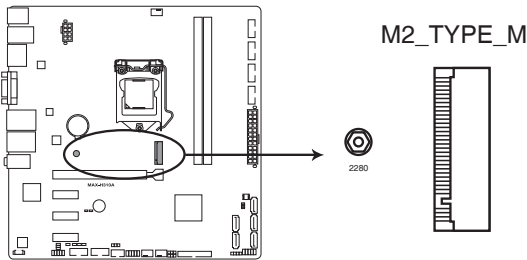

**MAX-H310A M.2 (M-key)**

## 8. Serial port connectors (10-1 pin COM1~COM6)

These connectors are for serial (COM) ports. Connect the serial port module cable to this connector, then install the module to a slot opening at the back of the system chassis.

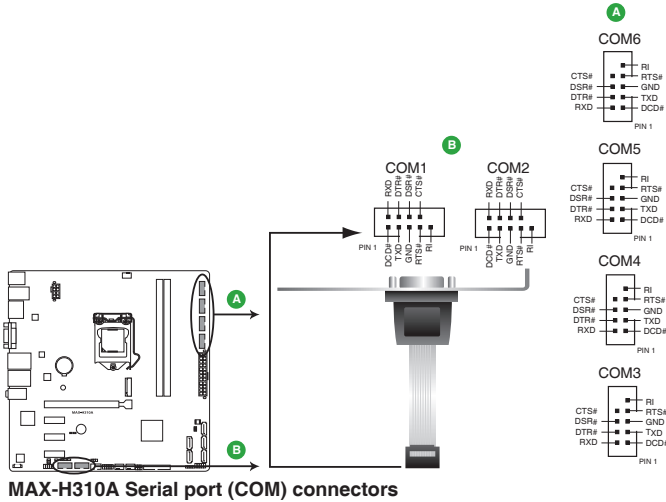

### NOTE:

- The COM module is purchased separately.
- COM1 also supports RS-232 / RS-422 / RS-485. See the table below and section 3.3.2 Super IO Configuration for details.

Pin	Signal	Pin	Signal
1	DCD# (422TXD-/485DATA-)	2	RXD (422TXD+/485DATA+)
3	TXD (422RXD+)	4	DTR# (422RXD-)
5	GND	6	DSR#
7	RTS#	8	CTS#
9	RI/+5V/+12V	10	N.C.

## 9. Audio amplifier connector (4-pin AMP\_CON)

This connector is for an internal stereo amplifier speakers support (2W/4Ω via WtoB header).

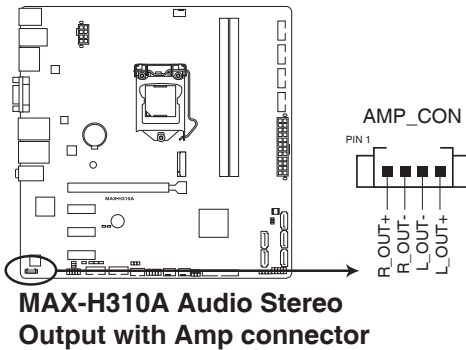

## 10. USB 2.0 connector (10-pin USB2.0)

This USB connectors complies with USB 2.0 specifications.

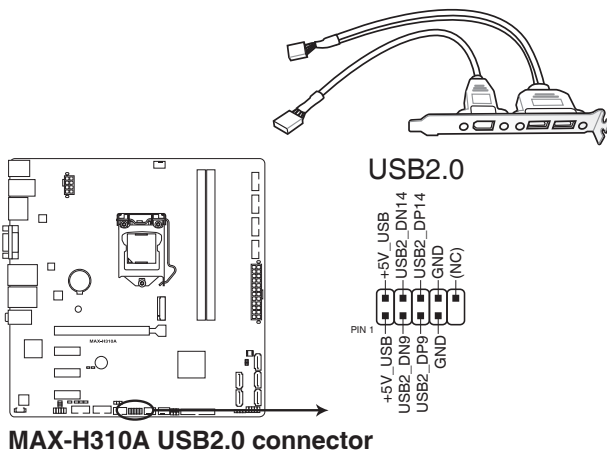

Never connect a 1394 cable to the USB connector. Doing so will damage the motherboard.

## 11. LPC Box header (26-pin LPC)

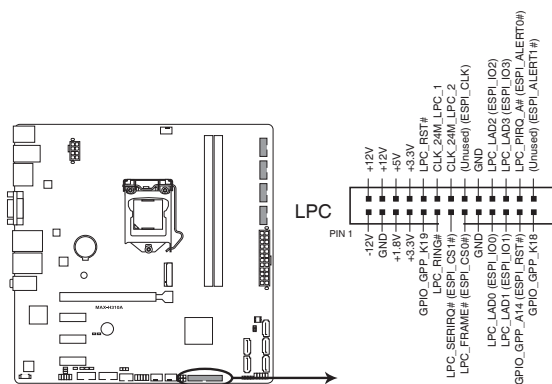

**MAX-H310A LPC Connector for IPC BU**

## 12. Digital I/O connector (10-pin DIO)

This connector includes 8 I/O lines (In/Out programmable). All of the Digital I/O lines are programmable and each I/O pin can be individually programmed to support various devices.

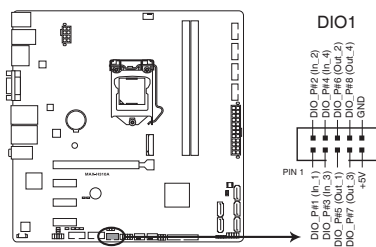

**MAX-H310A Digital I/O connector**

# Chapter 3

## BIOS setup

### 3.1 BIOS setup program

Use the BIOS Setup program to configure its parameters. The BIOS screens include navigation keys and brief online help to guide you in using the BIOS Setup program.

#### Entering BIOS Setup at startup

##### To enter BIOS Setup at startup:

Press <Delete> during the Power-On Self Test (POST). If you do not press <Delete>, POST continues with its routine.

#### Entering BIOS Setup after POST

##### To enter BIOS Setup after POST:

- Press <Ctrl>+<Alt>+<Del> simultaneously.
- Press the reset button on the system chassis.
- Press the power button to turn the system off then back on. Do this option only if you failed to enter BIOS Setup using the first two options.



---

**NOTE:** Using the power button, reset button, or the <Ctrl>+<Alt>+<Del> keys to reboot a running operating system can cause damage to your data or system. Always shut down the system properly from the operating system.

---



---

#### IMPORTANT:

- The default BIOS settings for this motherboard apply to most working conditions and ensures optimal performance. If the system becomes unstable after changing any BIOS settings, load the default settings to regain system stability. Select the option **Restore Defaults** under the Save & Exit Menu. See section 3.7 **Save & Exit**.
  - The BIOS setup screens shown in this section are for reference purposes only, and may not exactly match what you see on your screen.
-



### 3.1.1 BIOS menu screen

### 3.1.2 Menu bar

The menu bar on top of the screen has the following main items:

<b>Main</b>	For changing the basic system configuration.
<b>Advanced</b>	For changing the advanced system settings.
<b>Chipset</b>	For viewing and changing chipset settings.
<b>Security</b>	For setting up BIOS security settings.
<b>Boot</b>	For changing the system boot configuration.
<b>Save &amp; Exit</b>	For selecting the exit options and loading default settings.

To select an item on the menu bar, press the right or left arrow key on the keyboard until the desired item is highlighted.

## 3.2 Main menu

The Main menu provides you an overview of the basic system information, and allows you to set the system date, time, language, and security settings.

### 3.2.1 System Date [Day MM/DD/YYYY]

Allows you to set the system date.

### 3.2.2 System Time [HH:MM:SS]

Allows you to set the system time.

## 3.3 Advanced menu

The Advanced menu items allow you to change the settings for the CPU and other system devices.



---

Be cautious when changing the settings of the Advanced menu items. Incorrect field values can cause the system to malfunction.

---

### Case Open Warning [Disabled]

Allows you to enable or disable the case open detecting function. Configuration options: [Disable] [Enabled] [Clear]

### 3.3.1 CPU Configuration

The items in this menu show CPU-related information the BIOS automatically detects.



---

The items shown in the submenu may be different depending on the type of CPU installed.

---

### Hyper-threading [Enabled]

The Intel Hyper-Threading Technology allows a hyper-threading processor to appear as two logical processors to the operating system, allowing the operating system to schedule two threads or processes simultaneously.

[Enabled] Two threads per activated core are enabled.

[Disabled] Only one thread per activated core is enabled.



---

Configuration options for active processor cores are dependent on the installed CPU.

---

### Intel (VMX) Virtualization Technology [Enabled]

[Enabled] Allows a hardware platform to run multiple operating systems separately and simultaneously, enabling one system to virtually function as several systems.

[Disabled] Disables this function.

### 3.3.2 Trusted Computing

#### Security Device Support [Enable]

Allows you to enable or disable BIOS support for security devices. Configuration options: [Disable] [Enable]

#### SHA-1 PCR Bank [Enabled]

Allows you to enable or disable SHA-1 PCR Bank. Configuration options: [Disabled] [Enabled]

**SHA256 PCR Bank [Enable]**

Allows you to enable or disable SHA256 PCR Bank. Configuration options:  
[Disabled] [Enabled]

**Pending operation [None]**

Allows you to schedule an operation for the Security Device. Configuration options:  
[None] [TPM Clear]



---

The computer reboots during restart in order to change the state of the Security Device.

---

**Platform Hierarchy [Enabled]**

Allows you to enable or disable Platform Hierarchy. Configuration options:  
[Enabled] [Disabled]

**Storage Hierarchy [Enabled]**

Allows you to enable or disable Storage Hierarchy. Configuration options:  
[Enabled] [Disabled]

**Endorsement Hierarchy [Enabled]**

Allows you to enable or disable Endorsement Hierarchy. Configuration options:  
[Enabled] [Disabled]

**TPM2.0 UEFI Spec Version [TCG\_2]**

[TCG\_1\_2]                      Selects this spec version to support the compatible mode for Windows® 8 / Windows® 10.

[TCG\_2]                         Supports new TCG2 protocol and event format for Windows® 10 or later operating systems.

**Physical Presence Spec Version [1.3]**

Selects to tell operating system to support PPI Spec Version 1.2 or 1.3. Some HCK tests might not support 1.3. Configuration options: [1.2] [1.3]

**PH Randomization [Disabled]**

Allows you to select the PH Randomization. Configuration options: [Disabled] [Enabled]

**Device Select [Auto]**

Allows you to select the TPM device. Configuration options: [Auto] [TPM1.2] [TPM2.0]

### 3.3.3 SATA Configuration

The BIOS automatically detects the presence of SATA devices. The Serial ATA Ports listed will display **Empty** if there are no Serial devices connected to the ports.

#### SATA Controller(s) [Enabled]

Configuration options: [Enabled] [Disabled].



---

The following items appear only when you set **SATA Controller(s)** to [Enabled].

---

#### SATA Mode Selection [AHCI]

Allows you to set the SATA configuration.

[AHCI]

Set to [AHCI] when you want the SATA hard disk drives to use the AHCI (Advanced Host Controller Interface). The AHCI allows the onboard storage driver to enable advanced Serial ATA features that increases storage performance on random workloads by allowing the drive to internally optimize the order of commands.

#### Serial ATA Port 0/1/2

##### Port 0/1/2/3 [Enabled]

These items become configurable when you set the SATA Mode Selection item to [AHCI], and allow you to enable/disable the SATA port(s). Configuration options: [Disabled] [Enabled]

##### Hot Plug [Disabled]

These items become configurable when you set the SATA Mode Selection item to [AHCI], and allow you to enable/disable SATA Hot Plug Support. Configuration options: [Disabled] [Enabled]

#### Offboard SATA Controller Configuration

##### SATA Controller 0 Configuration Settings - Bus 1 Dev 0 Fun 0

This item shows the devices connected to the offboard SATA controller port.

### 3.3.4 USB Configuration



---

The USB Devices item lists auto-detected values. If no USB device is detected, the item shows None.

---

#### Legacy USB Support [Enabled]

[Enabled]

Enables the support for USB devices on legacy operating systems (OS).

[Disabled]

USB devices are only available when running BIOS Setup.

[Auto] Allows the system to detect the presence of USB devices at startup. If detected, the USB controller legacy mode is enabled. If no USB device is detected, the legacy USB support is disabled.

### **XHCI Hand-off [Enabled]**

[Enabled] Enables the support for operating systems without an XHCI hand-off feature.

[Disabled] Disables the XHCI Hand-off support.

## **3.3.5 Hardware Monitor**

The items in this menu allow you to configure the smart fan.

### **Smart Fan Configuration**

#### **CPU Smart Fan Control [Enabled]**

Allows you to enable or disable CPU Smart Fan Control. Configuration options:

[Enabled] [Disabled]



---

The following sub-items appear only when you set **CPU Smart Fan Control** to [Enabled].

---

#### **Fan Control Mode [Smart Fan IV Mode]**

Configuration options: [Manual Mode] [Thermal Cruise Mode] [Smart Fan IV Mode]



---

The following item appears only when you set **Fan Control Mode** to [Manual Mode].

---

#### **PWM/DC Voltage Output [255]**

Sets the voltage allocated for Fan Control. Input value range: [0~255]



---

The following items appear only when you set **Fan Control Mode** to [Thermal Cruise Mode].

---

#### **Target Temperature [50]**

Input value range: [0~127]

#### **Tolerance of Temperature [0]**

Input value range: [0~7]

#### **Fan Out Start-Up Value [127]**

Input value range: [0~255]

**Fan Stop Duty [Down to 0]**

Selects fan stop duty mode. Configuration options: [Down to 0] [To Fan Out Stop Value]

**Fan Out Stop Value [100]**

The Fan Out value decreases to this value if the temperature reaches below the lowest temperature limit. Input value range: [0~255]

**Fan Out Stop Time [60]**

Determines the amount of time it takes for the Fan Out value to fall from the stop value to zero. Input value range: [0~255]

**Critical Temperature [75]**

Determines the amount of time Fan Out takes to decrease its value by one step. Input value range: [0~255]

**Fan Out Step Up Time [10]**

Determines the amount of time Fan Out takes to increase its value by one step. Input value range: [0~255]

**Fan Out Step Down Time [10]**

Determines the amount of time Fan Out takes to decrease its value by one step in intervals of 0.1 seconds. Input value range: [0~255]



---

The following items appear only when you set **Fan Control Mode** to [Smart Fan IV Mode].

---

**Temperature 1 [40] / Temperature 2 [50] / Temperature 3 [60] /  
Temperature 4 [70]**

Determines the temperature value for the Smart Fan IV mode.

**Fan PWM 1 [150] / Fan PWM 2 [170] / Fan PWM 3 [200] / Fan PWM 4 [220]**

Determines the amount of Fan PWM value for the Smart Fan IV mode

**Tolerance of Temperature [0]**

Input value range: [0~7]

**Critical Temperature [75]**

Input value range: [0~255]

**Critical Temp Tolerance [0]**

Input value range: [0~7]

### **Fan Count Step Up [1]**

Input value range: [0~15]

### **Fan Count Step Down [1]**

Input value range: [0~15]

### **Fan Out Step Up Time [10]**

Determines the amount of time Fan Out takes to increase its value by one step. Input value range: [0~255]

### **Fan Out Step Down Time [10]**

Determines the amount of time Fan Out takes to decrease its value by one step in intervals of 0.1 seconds. Input value range: [0~255]

## **CHA\_FAN1/2 Smart Fan Control [Enabled]**

Allows you to enable or disable System Smart Fan Control. Configuration options: [Enabled] [Disabled]



---

The following sub-items appear only when you set **CHA\_FAN1/2 Smart Fan Control** to [Enabled].

---

### **Fan Control Mode [SMART FAN IV Mode]**

Configuration options: [Manual Mode] [Thermal Cruise Mode] [SMART FAN IV Mode]



---

The following items appear only when you set **Fan Control Mode** to [Manual Mode].

---

### **PWM/DC Voltage Output [255]**

This item appears only when you set the previous item to [Manual Mode] and allows you to set the voltage allocated for Fan Control. Input value range: [0~255]



---

The following items appear only when you set **Fan Control Mode** to [Thermal Cruise Mode].

---

### **Target Temperature [50]**

Input value range: [0~127]

### **Tolerance of Temperature [0]**

Input value range: [0~7]

### **Fan Out Start-Up Value [127]**

Input value range: [0~255]

### **Fan Stop Duty [To Fan Out Stop Value]**

Selects fan stop duty mode. Configuration options: [Down to 0] [To Fan Out Stop Value]

### **Fan Out Stop Value [100]**

The Fan Out value decreases to this value if the temperature reaches below the lowest temperature limit. Input value range: [0~255]

### **Fan Out Stop Time [60]**

Determines the amount of time it takes for the Fan Out value to fall from the stop value to zero. Input value range: [0~255]

### **Critical Temperature [75]**

Determines the amount of time Fan Out takes to decrease its value by one step. Input value range: [0~255]

### **Fan Out Step Up Time [10]**

Determines the amount of time Fan Out takes to increase its value by one step. Input value range: [0~255]

### **Fan Out Step Down Time [10]**

Determines the amount of time Fan Out takes to decrease its value by one step in intervals of 0.1 seconds. Input value range: [0~255]



---

The following items appear only when you set **Fan Control Mode** to [SMART FAN IV Mode].

---

### **Temperature 1 [40] / Temperature 2 [50] / Temperature 3 [60] / Temperature 4 [70]**

Determines the temperature value for the Smart Fan IV mode.

### **Fan PWM 1 [150] / Fan PWM 2 [170] / Fan PWM 3 [200] / Fan PWM 4 [220]**

Determines the amount of Fan PWM value for the Smart Fan IV mode.

### **Tolerance of Temperature [0]**

Input value range: [0~7]

### **Critical Temperature [75]**

Input value range: [0~255]



**Critical Temp Tolerance [0]**

Input value range: [0~7]

**Fan Count Step Up [1]**

Input value range: [0~15]

**Fan Count Step Down [1]**

Input value range: [0~15]

**Fan Out Step Up Time [10]**

Determines the amount of time Fan Out takes to increase its value by one step. Input value range: [0~255]

**Fan Out Step Down Time [10]**

Determines the amount of time Fan Out takes to decrease its value by one step in intervals of 0.1 seconds. Input value range: [0~255]

### 3.3.6 SIO Configuration

The items in this menu allow you to configure Super IO settings.

**[\*Active\*] Serial Port 1****Use this device [Enabled]**

Allows you to enable or disable this logical device. Configuration options: [Enabled] [Disabled]



---

The following two items appear only when you set **Use this device** to [Enabled].

---

**Possible [Use Automatic Settings]**

Allows you to select an optimal setting for Super I/O devices. Configuration options: [Use Automatic Settings] [IO=3F8h; IRQ=4;] [IO=3E8h; IRQ=7]

**Mode [RS-232]**

Allows you to select the Serial Port mode. Configuration options: [RS-232] [RS-422] [RS-485]

### **[\*Active\*] Serial Port 2**

#### **Use this device [Enabled]**

Allows you to enable or disable this logical device. Configuration options: [Enabled] [Disabled]

#### **Possible [Use Automatic Settings]**

This item appears only when you set **Use this device** to [Enabled] and allows you to select an optimal setting for Super I/O devices. Configuration options: [Use Automatic Settings] [IO=3E8h; IRQ=7] [IO=3F8h; IRQ=4;]

### **[\*Active\*] Serial Port 3**

#### **Use this device [Enabled]**

Allows you to enable or disable this logical device. Configuration options: [Enabled] [Disabled]

#### **Possible [Use Automatic Settings]**

This item appears only when you set **Use this device** to [Enabled] and allows you to select an optimal setting for Super I/O devices. Configuration options: [Use Automatic Settings] [IO=240h; IRQ=7; DMA] [IO=240h; IRQ=3,4,5,6,7,10,11,12; DMA] [IO=248h; IRQ=3,4,5,6,7,10,11,12; DMA] [IO=250h; IRQ=3,4,5,6,7,10,11,12; DMA] [IO=258h; IRQ=3,4,5,6,7,10,11,12; DMA]

### **[\*Active\*] Serial Port 4**

#### **Use this device [Enabled]**

Allows you to enable or disable this logical device. Configuration options: [Enabled] [Disabled]

#### **Possible [Use Automatic Settings]**

This item appears only when you set **Use this device** to [Enabled] and allows you to select an optimal setting for Super I/O devices. Configuration options: [Use Automatic Settings] [IO=248h; IRQ=7; DMA] [IO=240h; IRQ=3,4,5,6,7,10,11,12; DMA] [IO=248h; IRQ=3,4,5,6,7,10,11,12; DMA] [IO=250h; IRQ=3,4,5,6,7,10,11,12; DMA] [IO=258h; IRQ=3,4,5,6,7,10,11,12; DMA]

### **[\*Active\*] Serial Port 5**

#### **Use this device [Enabled]**

Allows you to enable or disable this logical device. Configuration options: [Enabled] [Disabled]

### **Possible [Use Automatic Settings]**

This item appears only when you set **Use this device** to [Enabled] and allows you to select an optimal setting for Super I/O devices. Configuration options: [Use Automatic Settings] [IO=250h; IRQ=7; DMA] [IO=240h; IRQ=3,4,5,6,7,10,11,12; DMA] [IO=248h; IRQ=3,4,5,6,7,10,11,12; DMA] [IO=250h; IRQ=3,4,5,6,7,10,11,12; DMA] [IO=258h; IRQ=3,4,5,6,7,10,11,12; DMA]

## **[\*Active\*] Serial Port 6**

### **Use this device [Enabled]**

Allows you to enable or disable this logical device. Configuration options: [Enabled] [Disabled]

### **Possible [Use Automatic Settings]**

Allows you to select an optimal setting for Super I/O devices. Configuration options: [Use Automatic Settings] [IO=258h; IRQ=7; DMA] [IO=240h; IRQ=3,4,5,6,7,10,11,12; DMA] [IO=248h; IRQ=3,4,5,6,7,10,11,12; DMA] [IO=250h; IRQ=3,4,5,6,7,10,11,12; DMA] [IO=258h; IRQ=3,4,5,6,7,10,11,12; DMA]

## **3.3.7 PCH-FW Configuration**

The items listed in this screen display firmware related information.

### **Firmware Update Configuration**

#### **Me FW Image Re-Flash [Disabled]**

Allows you to enable or disable Me firmware Image Re-Flash function. Configuration options: [Disabled] [Enabled]

## **3.3.8 Power Management**

### **Restore AC Power Loss [Last State]**

[Last State] The system goes into either off or on state, whatever the system state was.

[Always On] The system goes into on state after an AC power loss.

[Always Off] The system goes into off state after an AC power loss.

### **RI Wake Event [Disabled]**

Enable or disable system wake up from RI#. Configuration options: [Enabled] [Disabled]

### RTC Wake system from S5 [Disabled]

- [Disabled] Disables system wake up from S5.
- [Fixed Time] The system will wake up at the specified hr::min::sec.  
Configuration options: [Disabled] [Enabled] .
- [Dynamic Time] The system will wake up at the current time plus a specified number of minutes.



---

The following items appear when Fixed Time is enabled.

---

#### Wake up day/hour/minute/second [0]

Specify the values for day/hour/minute/second.



---

The following item appears when Wake System with Dynamic Time is enabled.

---

#### Wake up minute increase [1]

Specify the number of minutes added to the current time before waking up system. Input value range: [1~5]

## 3.3.9 Digital IO Port Configuration

The items listed in this screen configure Digital IO settings.

### DIO Port1~DIO Port4 [Output]

Configuration options: [Input] [Output]



---

The following item appears only when you set **DIO Port1/2/3/4** to [Output].

---

#### Output Level [High]

Configuration options: [High] [Low]

### DIO Port5~DIO Port8 [Input]

Configuration options: [Input] [Output]

## 3.4 Chipset menu

The Chipset menu items allow you to change the settings for the chipset.

### 3.4.1 System Agent (SA) Configuration

#### Max TOLUD [Dynamic]

Configures the maximum value of TOLUD. Dynamic assignment will adjust TOLUD automatically based on the largest MMIO length of installed graphics controller.

Configuration options: [Dynamic] [1GB] [1.25GB] ~ [3.5GB]

### **Primary Display [Auto]**

Allows you to decide which graphics controller to use as the primary boot device. Configuration options: [Auto] [IGFX] [PCI]

### **Primary IGFX Boot Display [VBIOS Default]**

Select the video device which will be activated during POST. This setting has no effect if an external graphics device is present. The secondary boot display selection appears based on your selection and the VGA mode is supported only on primary display. Configuration options: [VBIOS Default] [DP] [HDMI] [VGA]

### **PCIEX16 Gen Speed [Auto]**

Allows you to select the PCI Express port speed. Configuration options: [Auto] [Gen1] [Gen2] [Gen 3]

## **3.4.2 PCH-IO Configuration**

### **HD Audio [Enabled]**

This item controls the detection of HD Audio devices. Configuration options: [Disabled] [Enabled]

### **PCIEX1\_1 Gen Speed [Auto]**

Configures the speed of PCI Express x1 slot. Configuration options: [Auto] [Gen1] [Gen2]

### **PCIEX1\_2 Gen Speed [Auto]**

Configures the speed of PCI Express x1 slot. Configuration options: [Auto] [Gen1] [Gen2]

### **PCIEX1\_3 Gen Speed [Auto]**

Configures the speed of PCI Express x1 slot. Configuration options: [Auto] [Gen1] [Gen2]

## **3.5 Security menu**

The Security menu items allow you to change the system security settings.

### **3.5.1 Administrator Password**

If you have set an administrator password, we recommend that you enter the administrator password for accessing the system. Otherwise, you might be able to see or change only selected fields in the BIOS setup program.

### To set an administrator password:

1. Select the **Administrator Password** item and press <Enter>.
2. From the **Create New Password** box, key in a password, then press <Enter>.
3. Confirm the password when prompted.

### To change an administrator password:

1. Select the **Administrator Password** item and press <Enter>.
2. From the **Enter Current Password** box, key in the current password, then press <Enter>.
3. From the **Create New Password** box, key in a new password, then press <Enter>.
4. Confirm the password when prompted.

To clear the administrator password, follow the same steps as in changing an administrator password, but press <Enter> when prompted to create/confirm the password. After you clear the password, the **Administrator Password** item on top of the screen shows **Not Installed**.

## 3.5.2 User Password

If you have set a user password, you must enter the user password for accessing the system. The User Password item on top of the screen shows the default Not Installed. After you set a password, this item shows Installed.

### To set a user password:

1. Select the **User Password** item and press <Enter>.
2. From the **Create New Password** box, key in a password, then press <Enter>.
3. Confirm the password when prompted.

### To change a user password:

1. Select the **User Password** item and press <Enter>.
2. From the **Enter Current Password** box, key in the current password, then press <Enter>.
3. From the **Create New Password** box, key in a new password, then press <Enter>.
4. Confirm the password when prompted.

To clear the user password, follow the same steps as in changing a user password, but press <Enter> when prompted to create/confirm the password. After you clear the password, the **User Password** item on top of the screen shows **Not Installed**.

## 3.6 Boot menu

The Boot menu items allow you to change the system boot options.

### 3.6.1 Boot Configuration

#### **Quiet Boot [Enabled]**

This item enables/disables Quiet Boot. Configuration options: [Disabled] [Enabled]

#### **Network Stack [Disabled]**

This item allows user to disable or enable the UEFI network stack. Configuration options: [Disabled] [Enabled]

#### **Launch PXE ROM [Do not launch]**

This item controls the execution of Legacy PXE OpROM. Configuration options: [Legacy] [Do not Launch]

#### **FIXED BOOT ORDER Priorities**

##### **Boot Option #1-#14**

This item allows you to set the system boot order. Configuration options: [UEFI USB Key] [UEFI Hard Disk] [UEFI USB Hard Disk] [UEFI Network] [UEFI USB Lan] [UEFI CD/DVD] [UEFI USB CD/DVD] [USB Key] [Hard Disk] [USB Hard Disk] [Network] [USB Lan] [CD/DVD] [USB CD/DVD] [Disabled]

## 3.7 Save & Exit menu

#### **Save Changes and Reset**

Once you are finished making your selections, choose this option from the Save & Exit menu to reset the system after saving the changes. When you select this option, a confirmation window appears. Select Yes to save changes and reset.

#### **Discard Changes and Exit**

This option allows you to exit the Setup program without saving your changes. When you select this option or if you press <Esc>, a confirmation window appears. Select Yes to discard changes and exit.

#### **Restore Defaults**

Restores / Load Default values for all the setup options.

# Appendix

## Notices

### Federal Communications Commission Statement

This device complies with Part 15 of the FCC Rules. Operation is subject to the following two conditions:

- This device may not cause harmful interference.
- This device must accept any interference received including interference that may cause undesired operation.

This equipment has been tested and found to comply with the limits for a Class A digital device, pursuant to Part 15 of the FCC Rules. These limits are designed to provide reasonable protection against harmful interference in a residential installation. This equipment generates, uses and can radiate radio frequency energy and, if not installed and used in accordance with manufacturer's instructions, may cause harmful interference to radio communications. However, there is no guarantee that interference will not occur in a particular installation. If this equipment does cause harmful interference to radio or television reception, which can be determined by turning the equipment off and on, the user is encouraged to try to correct the interference by one or more of the following measures:

- Reorient or relocate the receiving antenna.
- Increase the separation between the equipment and receiver.
- Connect the equipment to an outlet on a circuit different from that to which the receiver is connected.
- Consult the dealer or an experienced radio/TV technician for help.



---

**WARNING!** The use of shielded cables for connection of the monitor to the graphics card is required to assure compliance with FCC regulations. Changes or modifications to this unit not expressly approved by the party responsible for compliance could void the user's authority to operate this equipment.

---



---

DO NOT throw the motherboard in municipal waste. This product has been designed to enable proper reuse of parts and recycling. This symbol of the crossed out wheeled bin indicates that the product (electrical and electronic equipment) should not be placed in municipal waste. Check local regulations for disposal of electronic products.

---



---

DO NOT throw the mercury-containing button cell battery in municipal waste. This symbol of the crossed out wheeled bin indicates that the battery should not be placed in municipal waste.

---





電子信息產品污染控制標示：圖中之數字為產品之環保使用期限。僅指電子信息產品中含有的有毒有害物質或元素不致發生外洩或突變從而對環境造成污染或對人身、財產造成嚴重損害的期限。

**有毒有害物質或元素的名稱及含量說明標示：**

部件名稱	有害物質或元素					
	鉛 (Pb)	汞 (Hg)	鎘 (Cd)	六 價 鉻 (Cr(VI))	多 溴 聯 苯 (PBB)	多 溴 二 苯 醚 (PBDE)
印刷電路板及其電子組件	×	○	○	○	○	○
外部信號連接頭及線材	×	○	○	○	○	○

○：表示該有毒有害物質在該部件所有均質材料中的含量均在 SJ/T 11363-2006 標準規定的限量要求以下。

×

×：表示該有毒有害物質至少在該部件的某一均質材料中的含量超出 SJ/T 11363-2006 標準規定的限量要求，然該部件仍符合歐盟指令 2002/95/EC 的規範。

備註：此產品所標示之環保使用期限，係指在一般正常使用狀況下。