

# GENE-BT06

---

3.5" Subcompact Board

User's Manual 4<sup>th</sup> Ed

## Copyright Notice

---

This document is copyrighted, 2016. All rights are reserved. The original manufacturer reserves the right to make improvements to the products described in this manual at any time without notice.

No part of this manual may be reproduced, copied, translated, or transmitted in any form or by any means without the prior written permission of the original manufacturer. Information provided in this manual is intended to be accurate and reliable. However, the original manufacturer assumes no responsibility for its use, or for any infringements upon the rights of third parties that may result from its use.

The material in this document is for product information only and is subject to change without notice. While reasonable efforts have been made in the preparation of this document to assure its accuracy, AAEMON assumes no liabilities resulting from errors or omissions in this document, or from the use of the information contained herein.

AAEMON reserves the right to make changes in the product design without notice to its users.

## Acknowledgement

---

All other products' name or trademarks are properties of their respective owners.

- Microsoft Windows is a registered trademark of Microsoft Corp.
- Intel, Pentium, Celeron, and Xeon are registered trademarks of Intel Corporation
- Core, Atom are trademarks of Intel Corporation
- ITE is a trademark of Integrated Technology Express, Inc.
- IBM, PC/AT, PS/2, and VGA are trademarks of International Business Machines Corporation.

All other product names or trademarks are properties of their respective owners.

## Packing List

---

Before setting up your product, please make sure the following items have been shipped:

Item	Quantity
● GENE-BT06 with heat spreader	1
● Product DVD with User's Manual (in pdf) and drivers	1

If any of these items are missing or damaged, please contact your distributor or sales representative immediately.

## About this Document

---

This User's Manual contains all the essential information, such as detailed descriptions and explanations on the product's hardware and software features (if any), its specifications, dimensions, jumper/connector settings/definitions, and driver installation instructions (if any), to facilitate users in setting up their product.

Users may refer to the [AAEON.com](http://AAEON.com) for the latest version of this document.

## Safety Precautions

---

Please read the following safety instructions carefully. It is advised that you keep this manual for future references

1. All cautions and warnings on the device should be noted.
2. Make sure the power source matches the power rating of the device.
3. Position the power cord so that people cannot step on it. Do not place anything over the power cord.
4. Always completely disconnect the power before working on the system's hardware.
5. No connections should be made when the system is powered as a sudden rush of power may damage sensitive electronic components.
6. If the device is not to be used for a long time, disconnect it from the power supply to avoid damage by transient over-voltage.
7. Always disconnect this device from any AC supply before cleaning.
8. While cleaning, use a damp cloth instead of liquid or spray detergents.
9. Make sure the device is installed near a power outlet and is easily accessible.
10. Keep this device away from humidity.
11. Place the device on a solid surface during installation to prevent falls
12. Do not cover the openings on the device to ensure optimal heat dissipation.
13. Watch out for high temperatures when the system is running.
14. Do not touch the heat sink or heat spreader when the system is running
15. Never pour any liquid into the openings. This could cause fire or electric shock.
16. As most electronic components are sensitive to static electrical charge, be sure to ground yourself to prevent static charge when installing the internal components. Use a grounding wrist strap and contain all electronic components in any static-shielded containers.

17. If any of the following situations arises, please the contact our service personnel:
  - i. Damaged power cord or plug
  - ii. Liquid intrusion to the device
  - iii. Exposure to moisture
  - iv. Device is not working as expected or in a manner as described in this manual
  - v. The device is dropped or damaged
  - vi. Any obvious signs of damage displayed on the device
18. **DO NOT LEAVE THIS DEVICE IN AN UNCONTROLLED ENVIRONMENT WITH TEMPERATURES BEYOND THE DEVICE'S PERMITTED STORAGE TEMPERATURES (SEE CHAPTER 1) TO PREVENT DAMAGE.**

### **Warning!**



This device complies with Part 15 FCC Rules. Operation is subject to the following two conditions: (1) this device may not cause harmful interference, and (2) this device must accept any interference received including interference that may cause undesired operation.

### **Caution:**

*There is a danger of explosion if the battery is incorrectly replaced. Replace only with the same or equivalent type recommended by the manufacturer. Dispose of used batteries according to the manufacturer's instructions and your local government's recycling or disposal directives.*

### **Attention:**

*Il y a un risque d'explosion si la batterie est remplacée de façon incorrecte. Ne la remplacer qu'avec le même modèle ou équivalent recommandé par le constructeur. Recycler les batteries usées en accord avec les instructions du fabricant et les directives gouvernementales de recyclage.*



## China RoHS Requirements (CN)

产品中有毒有害物质或元素名称及含量

AAEON Main Board/ Daughter Board/ Backplane

部件名称	有毒有害物质或元素					
	铅 (Pb)	汞 (Hg)	镉 (Cd)	六价铬 (Cr(VI))	多溴联苯 (PBB)	多溴二苯醚 (PBDE)
印刷电路板 及其电子组件	×	○	○	○	○	○
外部信号 连接器及线材	×	○	○	○	○	○

○: 表示该有毒有害物质在该部件所有均质材料中的含量均在 SJ/T 11363-2006 标准规定的限量要求以下。

X: 表示该有毒有害物质至少在该部件的某一均质材料中的含量超出 SJ/T 11363-2006 标准规定的限量要求。

备注: 此产品所标示之环保使用期限, 系指在一般正常使用状况下。

## China RoHS Requirement (EN)

Poisonous or Hazardous Substances or Elements in Products

AAEON Main Board/ Daughter Board/ Backplane

Component	Poisonous or Hazardous Substances or Elements					
	Lead (Pb)	Mercury (Hg)	Cadmium (Cd)	Hexavalent Chromium (Cr(VI))	Polybrominated Biphenyls (PBB)	Polybrominated Diphenyl Ethers (PBDE)
PCB & Other Components	X	○	○	○	○	○
Wires & Connectors for External Connections	X	○	○	○	○	○
<p>O: The quantity of poisonous or hazardous substances or elements found in each of the component's parts is below the SJ/T 11363-2006-stipulated requirement.</p> <p>X: The quantity of poisonous or hazardous substances or elements found in at least one of the component's parts is beyond the SJ/T 11363-2006-stipulated requirement.</p> <p><b>Note:</b> The Environment Friendly Use Period as labeled on this product is applicable under normal usage only</p>						

## Table of Contents

---

<b>Chapter 1 - Product Specifications</b> .....	<b>1</b>
1.1 Specifications.....	2
<b>Chapter 2 – Hardware Information</b> .....	<b>4</b>
2.1 Dimensions .....	5
2.2 Jumpers and Connectors.....	9
2.3 Assembly Options .....	13
2.4 Block Diagram.....	15
2.5 List of Jumpers .....	16
2.5.1 COM3 Pin8 Function Selection (JP1).....	17
2.5.2 COM2 Pin8 Function Selection (JP2).....	17
2.5.3 LVDS Port Operating VDD Selection (JP3).....	17
2.5.4 LVDS Port Backlight Inverter VCC Selection (JP4) .....	17
2.5.5 LVDS Port Backlight Lightness Control Mode Selection (JP5).....	18
2.5.6 Auto Power Button Enable/ Disable Selection (JP6) .....	18
2.5.7 Front Panel Connector (JP7) .....	18
2.5.8 Clear CMOS Jumper (JP8).....	18
2.5.9 Touch Screen 4,5,8 Wire Selection (JP9).....	19
2.6 List of Connectors.....	20
2.6.1 Amplifier R-Channel Output (CN1).....	22
2.6.2 Amplifier L-Channel Output (CN2).....	22
2.6.3 +5VVB Output w/ SMBus (CN3).....	22
2.6.4 Digital I/O Port (CN4).....	23
2.6.5 External +5VSB Input (CN5).....	23
2.6.6 +5V Output for SATA HDD (CN6).....	24
2.6.7 SATA Port 1 (CN7) .....	24
2.6.8 External Power Input (CN8).....	25

2.6.9	Audio I/O Port (CN9).....	25
2.6.10	COM Port 4 (CN10) .....	26
2.6.11	LCP Port (CN11).....	27
2.6.12	COM Port 3 (CN12) .....	28
2.6.13	UIM Card Socket (CN13) .....	30
2.6.14	MiniCard Slot (Half-MiniCard).....	30
2.6.15	COM Port 2 (CN15) .....	32
2.6.16	BIOS Debug Port (CN16).....	35
2.6.17	MiniCard Slot (Full-MiniCard) .....	35
2.6.18	USB 2.0 Port 3 (CN18).....	37
2.6.19	USB 2.0 Port 2 (CN19).....	38
2.6.20	LVDS Port (CN21).....	38
2.6.21	PS/2 Keyboard/ Mouse Combo Port (CN22).....	40
2.6.22	Touch Screen Connector (CN23) .....	40
2.6.23	LVDS Port Inverter/ Backlight Connector (CN24).....	42
2.6.24	CPU FAN (CN25).....	43
2.6.25	LAN (RJ-45) Port 2 (CN26).....	43
2.6.26	LAN (RJ-45) Port 1 (CN27).....	44
2.6.27	USB Port 0 and 1 (CN28).....	45
2.6.28	DP Port (CN29).....	45
2.6.30	COM Port 1 (D-SUB 9) (CN30).....	46
2.6.30	HDMI Port (CN31).....	47
2.6.31	Battery (CN32).....	48
2.6.32	VGA Port (CN33).....	48
<b>Chapter 3</b>	<b>- AMI BIOS Setup .....</b>	<b>50</b>
3.1	System Test and Initialization .....	51
3.2	AMI BIOS Setup .....	52
3.3	Setup submenu: Main .....	53

3.4	Setup submenu: Advanced .....	54
3.4.1	Advanced: Power Management.....	55
3.4.1.1	Power Management: S5 RTC Wake Settings.....	57
3.4.2	Advanced: Super IO Configuration .....	59
3.4.2.1	Super IO Configuration: Serial Port 1 Configuration .....	60
3.4.2.2	Super IO Configuration: Serial Port 2 Configuration .....	61
3.4.2.3	Super IO Configuration: Serial Port 3 Configuration .....	62
3.4.2.4	Super IO Configuration: Serial Port 4 Configuration .....	63
3.4.2.5	Super IO Configuration: Smart Fan Function .....	66
3.4.2.6	Super IO Configuration: Smart Fan Mode Configuration.....	67
3.4.3	Advanced: Digital IO.....	68
3.4.4	Advanced: H/W Monitor .....	69
3.4.4	Advanced: CPU Configuration .....	70
3.4.4.1	CPU Configuration: Socket 0 CPU Information.....	71
3.4.5	Advanced: IDE Configuration .....	72
3.4.6	Advanced: CSM Configuration.....	74
3.4.7	Advanced: Trusted Computing.....	75
3.4.8	Advanced: USB Configuration.....	76
3.4.9	Advanced: Touch Device.....	78
3.5	Setup submenu: Chipset.....	79
3.5.1	Chipset: Host Bridge.....	80
3.5.1.1	Host Bridge: IGD - LCD Control .....	81
3.5.2	Chipset: South Bridge.....	83
3.5.2.1	South Bridge: Azalia HD Audio .....	84
3.5.2.2	South Bridge: USB Configuration.....	86
3.5.2.3	South Bridge: PCI Express Configuration .....	88
3.6	Setup submenu: Security .....	89
3.7	Setup submenu: Boot.....	91

3.8 Setup submenu: Exit .....	92
<b>Chapter 4 – Drivers Installation.....</b>	<b>93</b>
4.1 Product CD/DVD .....	94
<b>Appendix A - Watchdog Timer Programming.....</b>	<b>103</b>
A.1 Watchdog Timer Registers .....	104
A.2 Watchdog Sample Program.....	106
<b>Appendix B - I/O Information .....</b>	<b>108</b>
B.1 I/O Address Map .....	109
B.2 Memory Address Map .....	111
B.3 IRQ Mapping Chart.....	112
<b>Appendix C – Mating Connectors .....</b>	<b>116</b>
C.1 List of Mating Connectors and Cables.....	117
<b>Appendix D – Electrical Specifications for I/O Ports.....</b>	<b>119</b>
D.1 Electrical Specifications for I/O Ports.....	120
<b>Appendix E – Digital I/O Ports .....</b>	<b>122</b>
E.1 Digital I/O Register.....	123
E.2 Digital I/O Sample Code (4 in 4 out, 2 low 2 high).....	125

# Chapter 1

---

Product Specifications

## 1.1 Specifications

---

### System

● Form Factor	3.5"
● Processor	Intel® Atom™ E3825/ E3845 Processor SoC
● System Memory	Onboard DDR3L 1333/1600 up to 4 GB
● Chipset	Intel® Atom™ Processor SoC
● Ethernet	Intel® I210/ I211 Gigabit Controller, RJ-45 x 2
● BIOS	SPI BIOS – 8 MB Flash
● Wake On LAN	Yes
● Watchdog Timer	Fintek F81866
● H/W Status Monitoring	CPU temperature, Voltage Status
● Expansion Interface	MiniCard x 2 LPC Interface SM Bus SIM Card Socket
● Power Requirement	0.64A@+12V - Intel® E3845, onboard DDR3L 1600MHz, 4G
● Power Consumption (Typical)	0.65 A @ +12 V
● Board Size	146 x 101.6 mm (5.7" x 4")
● Gross Weight	0.4 kg (0.88 lbs)
● Operating Temperature	0°C ~ 60°C (32°F ~ 140°F)



- **Storage Temperature** -40°C ~ 80°C (-40°F ~ 176°F)
- **Operation Humidity** 0 ~ 90% Relative Humidity, Non-Condensing

## Display

- **Chipset** Intel® Atom™ Processor SoC
- **Resolution** VGA up to 1920 x 1200  
LVDS up to 1920 x 1200
- **Output Interface** 18/24-bit Dual-Channel LVDS LCD

## I/O

- **Storage** SATA 3.0 Gb/s x 1
- **USB** USB 3.0 x 1  
USB 2.0 x 3
- **Serial Port** RS-232 x 2  
RS-232/422/485 x 2
- **PS/2 Port** Keyboard/ mouse internal connector x 1
- **DI/O** 8-bit programmable digital I/O
- **Audio** Realtek ALC892, Mic-in/ Line-in/ Line-out

# Chapter 2

---

Hardware Information

## 2.1 Dimensions

### Standard Ver. - Component Side

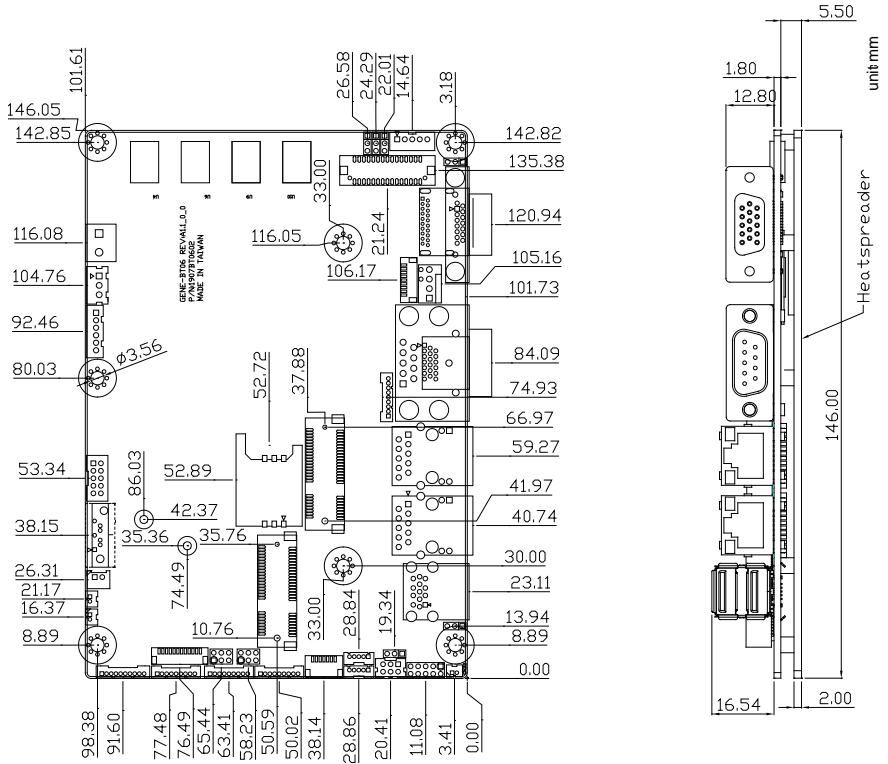

### Standard Ver. - Solder Side

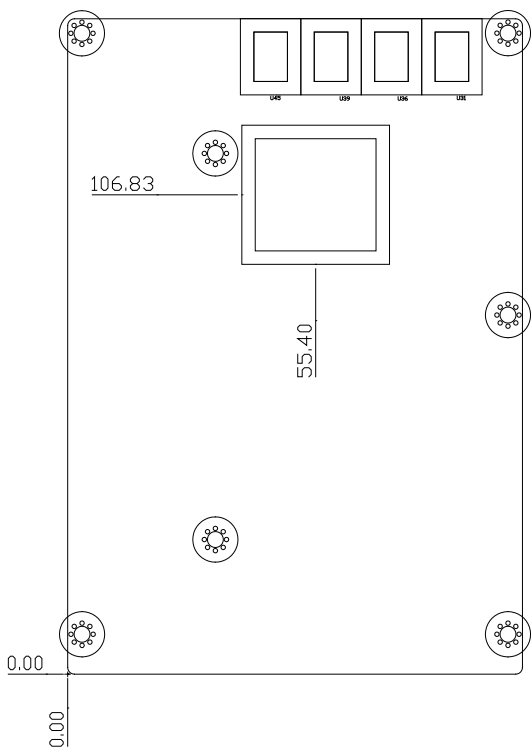

Advanced Ver. - Component Side

3.5" Subcompact Board

GENE-BT06

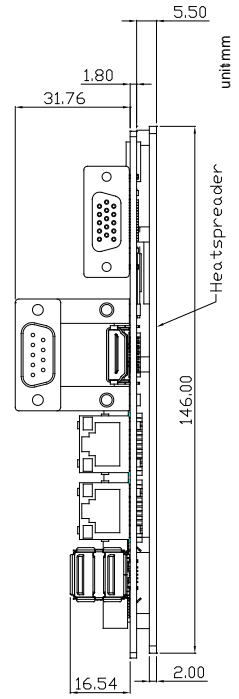
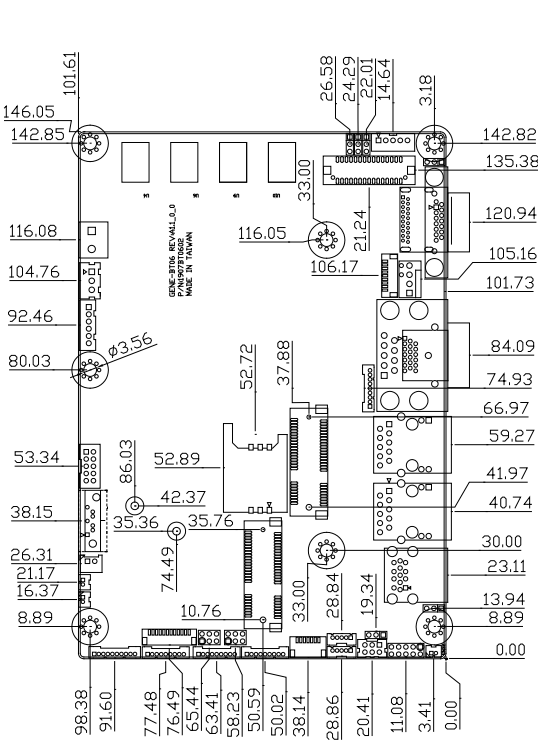

Advanced Ver. - Solder Side

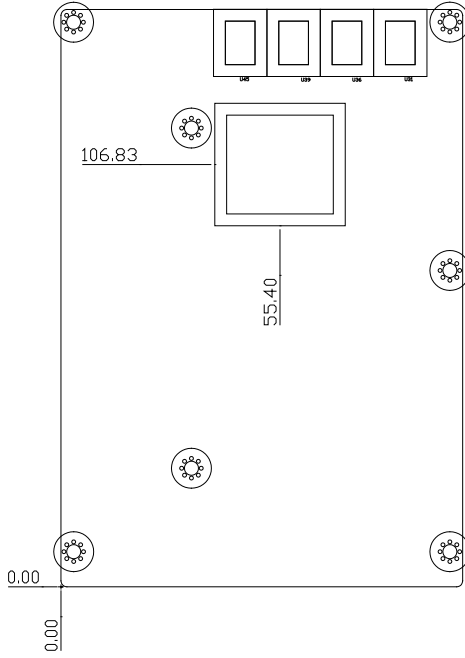

## 2.2 Jumpers and Connectors

### Standard Ver. - Component Side

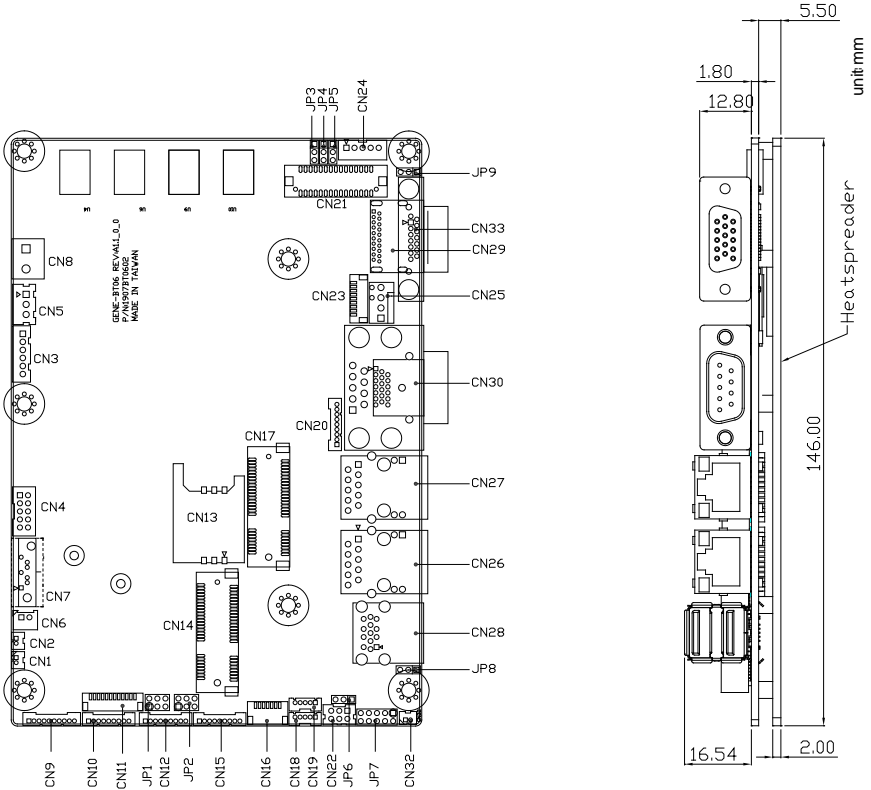

Standard Ver. - Solder Side

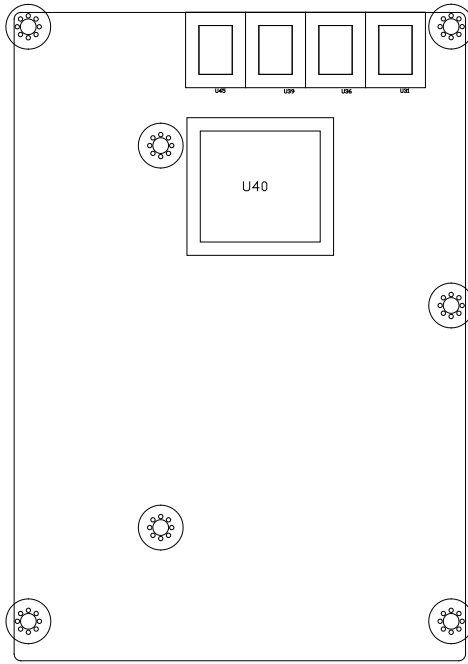



### Advanced Ver. - Component Side

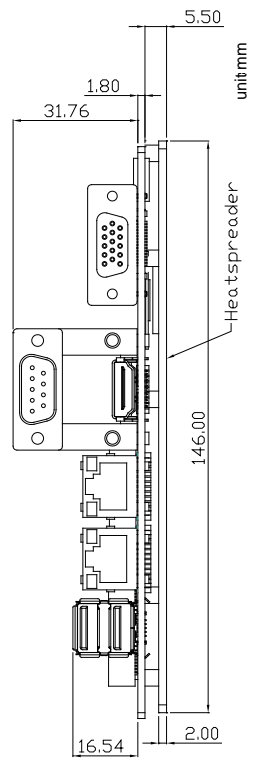
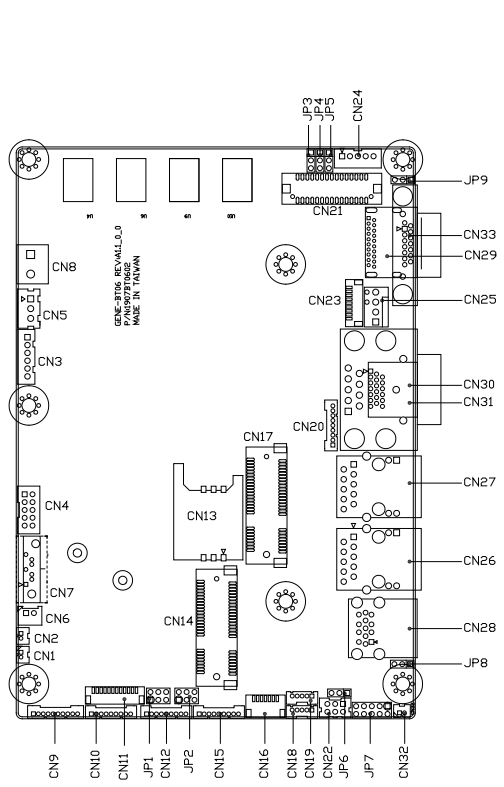

Advanced Ver. - Solder Side

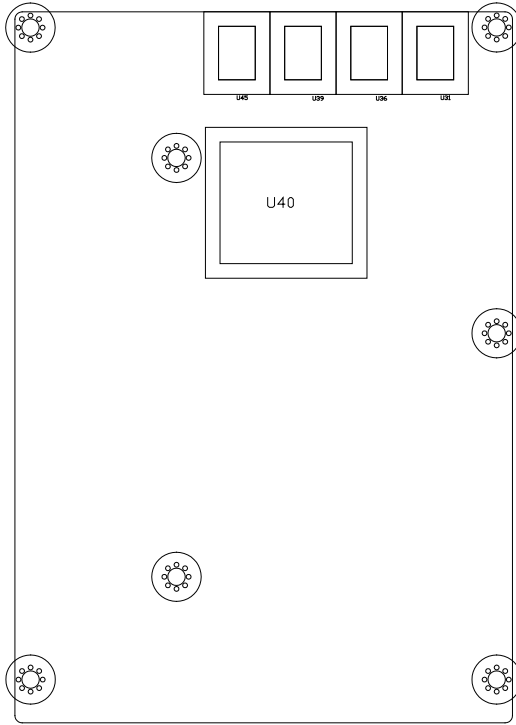

## 2.3 Assembly Options

### Option 1

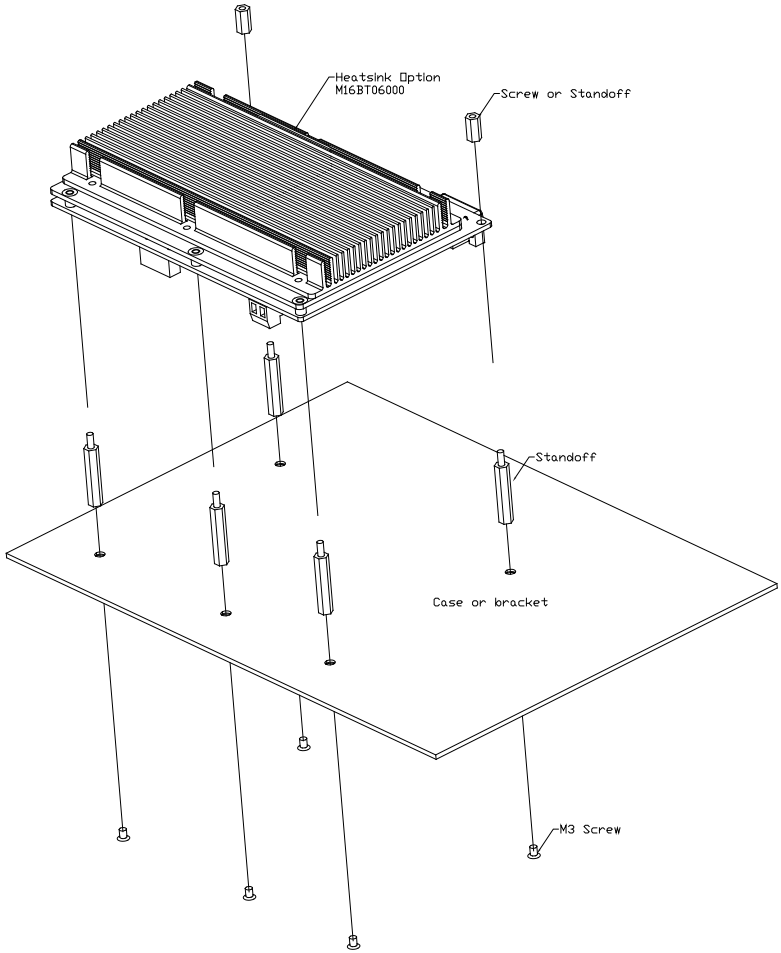

### Option 2

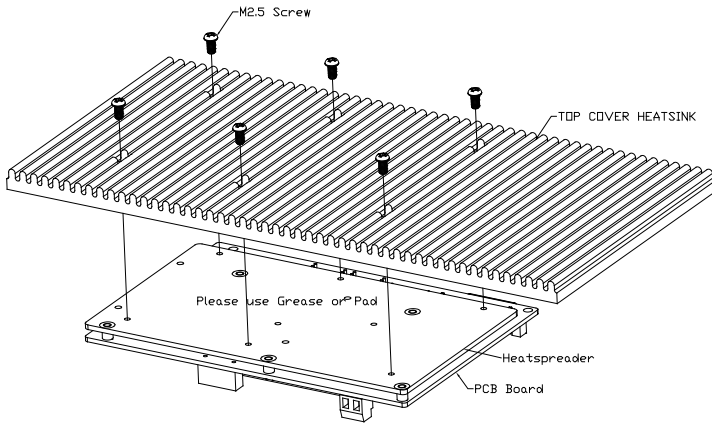

## 2.4 Block Diagram

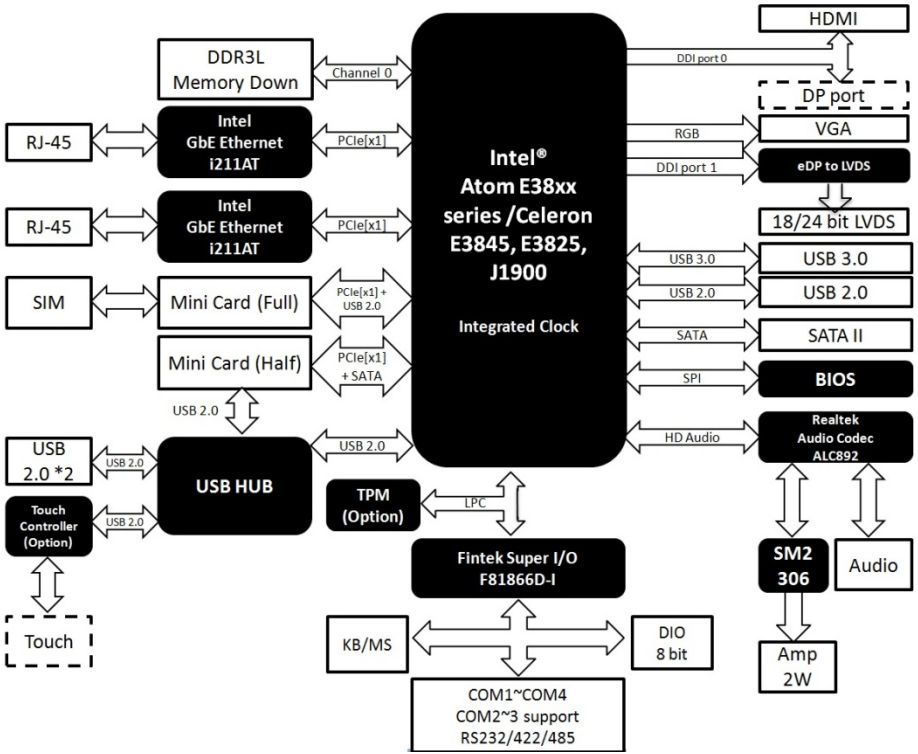

3.5" Subcompact Board

GENE-BT06

## 2.5 List of Jumpers

---

Please refer to the table below for all of the board's jumpers that you can configure for your application

Label	Function
JP1	COM3 Pin8 Function Selection
JP2	COM2 Pin8 Function Selection
JP3	LVDS Port Operating VDD Selection
JP4	LVDS Port Backlight Inverter VCC Selection
JP5	LVDS Port Backlight Lightness Control Mode Selection
JP6	Auto Power Button Enable/Disable Selection
JP7	Front Panel Connector
JP8	Clear CMOS Jumper
JP9	Touch Screen 4/5/8-wire Mode Selection

### 2.5.1 COM3 Pin8 Function Selection (JP1)

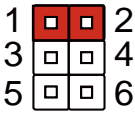

+12V

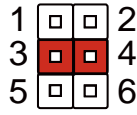

Ring(Default)

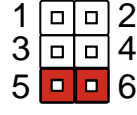

+5V

### 2.5.2 COM2 Pin8 Function Selection (JP2)

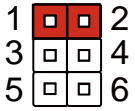

+12V

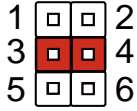

Ring(Default)

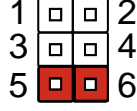

+5V

### 2.5.3 LVDS Port Operating VDD Selection (JP3)

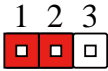

+5V

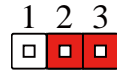

+3.3V (Default)

### 2.5.4 LVDS Port Backlight Inverter VCC Selection (JP4)

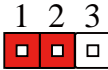

+12V



+5V (Default)

## 2.5.5 LVDS Port Backlight Lightness Control Mode Selection (JP5)



VR Mode (Default)

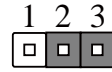

PWM Mode

## 2.5.6 Auto Power Button Enable/ Disable Selection (JP6)



Disable

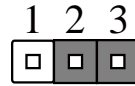

Enable (Default)

\* When disabled, the power button of JP7 (1-2) will be used to power on the system

## 2.5.7 Front Panel Connector (JP7)

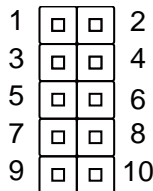

Pin	Signal	Pin	Signal
1	PWR_BTN-	2	PWR_BTN+
3	HDD_LED-	4	HDD_LED+
5	SPEAKER-	6	SPEAKER+
7	PWR_LED-	8	PWR_LED+
9	H/W RESET-	10	H/W RESET+

## 2.5.8 Clear CMOS Jumper (JP8)



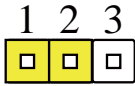

Normal (Default)

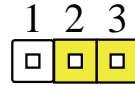

Clear CMOS

### 2.5.9 Touch Screen 4,5,8 Wire Selection (JP9)

---

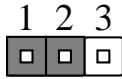

4/8 Wire Mode (Default)

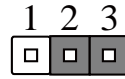

5 Wires Mode

## 2.6 List of Connectors

Please refer to the table below for all of the board's connectors that you can configure for your application

Label	Function
CN1	Amplifier R-channel output
CN2	Amplifier L-channel output
CN3	+5VSB Output w/SMBus
CN4	Digital IO Port
CN5	External +5VSB Input
CN6	+5V Output for SATA HDD
CN7	SATA Port
CN8	External Power Input
CN9	Audio I/O Port
CN10	COM Port 4
CN11	LPC Port
CN12	COM Port 3
CN13	UIM Card Socket
CN14	MiniCard Slot (Half-Mini Card)
CN15	COM Port 2
CN16	SPI Debug Port
CN17	MiniCard Slot (Full-Mini Card)
CN18	USB 2.0 Port 3
CN19	USB 2.0 Port 2
CN20	COM Port 1 (Wafer)
CN21	LVDS Port
CN22	PS/2 Keyboard/Mouse Combo Port
CN23	Touch Screen Connector

CN24	LVDS Port Inverter / Backlight Connector
CN25	CPU FAN (Optional)
CN26	LAN (RJ-45) Port2
CN27	LAN (RJ-45) Port1
CN28	USB Ports 0 and 1
CN29	DP Port
CN30	COM Port 1 (D-SUB 9)
CN31	HDMI Port
CN32	Battery
CN33	VGA Port

### 2.6.1 Amplifier R-Channel Output (CN1)

Pin	Pin Name	Signal Type	Signal Level
1	SKR_R+	OUT	
2	SKR_R-	OUT	

### 2.6.2 Amplifier L-Channel Output (CN2)

Pin	Pin Name	Signal Type	Signal Level
1	SKR_L+	OUT	
2	SKR_L-	OUT	

### 2.6.3 +5VVB Output w/ SMBus (CN3)

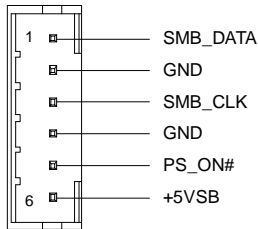

Pin	Pin Name	Signal Type	Signal Level
1	SMB_DATA	I/O	+3.3V
2	GND	GND	
3	SMB_CLK	I/O	+3.3V
4	GND	GND	
5	PS_ON#	OUT	+3.3V
6	+5VSB	PWR	+5V

## 2.6.4 Digital I/O Port (CN4)

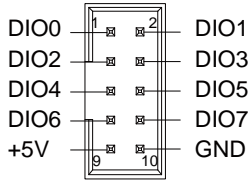

Pin	Pin Name	Signal Type	Signal Level
1	DIO0	I/O	+5V
2	DIO1	I/O	+5V
3	DIO2	I/O	+5V
4	DIO3	I/O	+5V
5	DIO4	I/O	+5V
6	DIO5	I/O	+5V
7	DIO6	I/O	+5V
8	DIO7	I/O	+5V
9	+5V	PWR	+5V
10	GND	GND	

## 2.6.5 External +5VSB Input (CN5)

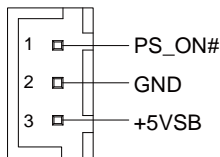

Pin	Pin Name	Signal Type	Signal Level
1	PS_ON#	OUT	+3.3V
2	GND	GND	
3	+5VSB	PWR	+5V

## 2.6.6 +5V Output for SATA HDD (CN6)

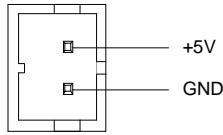

Pin	Pin Name	Signal Type	Signal Level
1	+5V	PWR	+5V
2	GND	GND	

## 2.6.7 SATA Port 1 (CN7)

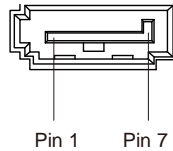

Pin	Pin Name	Signal Type	Signal Level
1	GND	GND	
2	SATA_TX+	DIFF	
3	SATA_TX-	DIFF	
4	GND	GND	
5	SATA_RX-	DIFF	
6	SATA_RX+	DIFF	
7	GND	GND	

## 2.6.8 External Power Input (CN8)

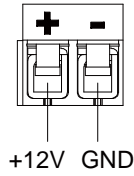

Pin	Pin Name	Signal Type	Signal Level
1	+12V	PWR	+9 ~ 24V (or +12V)
2	GND	GND	

## 2.6.9 Audio I/O Port (CN9)

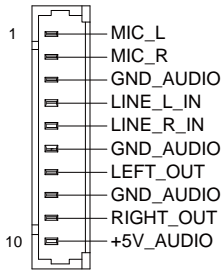

Pin	Pin Name	Signal Type	Signal Level
1	MIC_L	IN	
2	MIC_R	IN	
3	GND_AUDIO	GND	
4	LINE_L_IN	IN	
5	LINE_R_IN	IN	
6	GND_AUDIO	GND	
7	LEFT_OUT	OUT	
8	GND_AUDIO	GND	
9	RIGHT_OUT	OUT	

10	+5V_AUDIO	PWR	+5V
----	-----------	-----	-----

### 2.6.10 COM Port 4 (CN10)

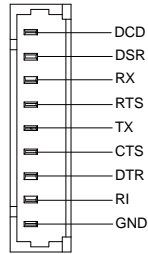

Pin	Pin Name	Signal Type	Signal Level
1	DCD	IN	
2	DSR	IN	
3	RX	IN	
4	RTS	OUT	±9V
5	TX	OUT	±9V
6	CTS	IN	
7	DTR	OUT	±9V
8	RI	IN	
9	GND	GND	



## 2.6.11 LCP Port (CN11)

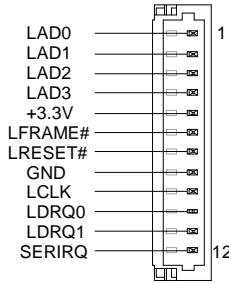

Pin	Pin Name	Signal Type	Signal Level
1	LAD0	I/O	+3.3V
2	LAD1	I/O	+3.3V
3	LAD2	I/O	+3.3V
4	LAD3	I/O	+3.3V
5	+3.3V	PWR	+3.3V
6	LFRAME#	IN	
7	LRESET#	OUT	+3.3V
8	GND	GND	
9	LCLK	OUT	
10	LDRQ0	IN	
11	LDRQ1	IN	
12	SERIRQ	I/O	+3.3V

## 2.6.12 COM Port 3 (CN12)

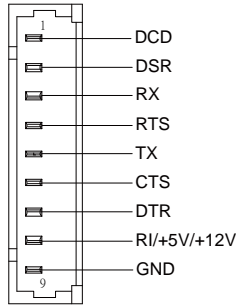

RS-232			
Pin	Pin Name	Signal Type	Signal Level
1	DCD	IN	
2	DSR	IN	
3	RX	IN	
4	RTS	OUT	±5V
5	TX	OUT	±5V
6	CTS	IN	
7	DTR	OUT	±5V
8	RI/+5V/+12V	IN/ PWR	+5V/+12V
9	GND	GND	

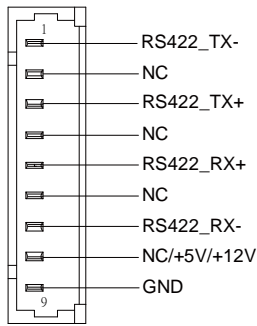

## RS-422

Pin	Pin Name	Signal Type	Signal Level
1	RS422_TX-	OUT	±5V
2	NC		
3	RS422_TX+	OUT	±5V
4	NC		
5	RS422_RX+	IN	
6	NC		
7	RS422_RX-	IN	
8	NC/+5V/+12V	PWR	+5V/+12V
9	GND	GND	

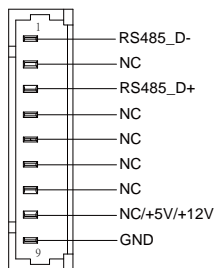

## RS-485

Pin	Pin Name	Signal Type	Signal Level
1	RS485_D-	I/O	±5V
2	NC		
3	RS485_D+	I/O	±5V
4	NC		
5	NC		
6	NC		
7	NC		
8	NC/+5V/+12V	PWR	+5V/+12V

---

9	GND	GND
---	-----	-----

---

\* COM3 RS232/422/485 can be set by BIOS settings. Default is RS-232

\* Function for pin 8 can be set by JP1

### 2.6.13 UIM Card Socket (CN13)

---

Pin	Pin Name	Signal Type	Signal Level
1	UIM_PWR	PWR	
2	UIM_RST	IN	
3	UIM_CLK	IN	
4	GND	GND	
5	UIM_VPP	PWR	
6	UIM_DATA	I/O	

### 2.6.14 MiniCard Slot (Half-MiniCard) (CN14)

---

Pin	Pin Name	Signal Type	Signal Level
1	PCIE_WAKE#	IN	
2	+3.3VSB	PWR	+3.3V
3	NC		
4	GND	GND	
5	NC		
6	+1.5V	PWR	+1.5V
7	PCIE_CLK_REQ#	IN	
8	NC		
9	GND	GND	
10	NC		

11	PCIE_REF_CLK-	DIFF	
12	NC		
13	PCIE_REF_CLK+	DIFF	
14	NC		
15	GND	GND	
16	NC		
17	NC		
18	GND	GND	
19	NC		
20	W_DISABLE#	OUT	+3.3V
21	GND	GND	
22	PCIE_RST#	OUT	+3.3V
23	PCIE_RX-	DIFF	
24	+3.3VSB	PWR	+3.3V
25	PCIE_RX+	DIFF	
26	GND	GND	
27	GND	GND	
28	+1.5V	PWR	+1.5V
29	GND	GND	
30	SMB_CLK	I/O	+3.3V
31	PCIE_TX-	DIFF	
32	SMB_DATA	I/O	+3.3V
33	PCIE_TX+	DIFF	
34	GND	GND	
35	GND	GND	
36	USB_D-	DIFF	
37	GND	GND	

38	USB_D+	DIFF	
39	+3.3VSB	PWR	+3.3V
40	GND	GND	
41	+3.3VSB	PWR	+3.3V
42	NC		
43	GND	GND	
44	NC		
45	NC		
46	NC		
47	NC		
48	+1.5V	PWR	+1.5V
49	NC		
50	GND	GND	
51	NC		
52	+3.3VSB	PWR	+3.3V

\* CN14 can be selected for MiniCard or mSATA by changing BOM

\* Only mSATA or CFast can be chosen on the motherboard

## 2.6.15 COM Port 2 (CN15)

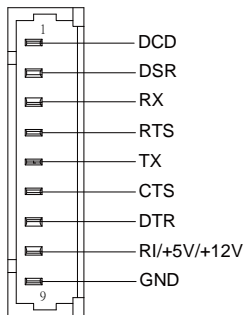

## RS-232

Pin	Pin Name	Signal Type	Signal Level
1	DCD	IN	
2	DSR	IN	
3	RX	IN	
4	RTS	OUT	±5V
5	TX	OUT	±5V
6	CTS	IN	
7	DTR	OUT	±5V
8	RI/+5V/+12V	IN/ PWR	+5V/+12V
9	GND	GND	

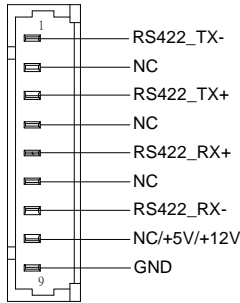

## RS-422

Pin	Pin Name	Signal Type	Signal Level
1	RS422_TX-	OUT	±5V
2	NC		
3	RS422_TX+	OUT	±5V
4	NC		
5	RS422_RX+	IN	
6	NC		
7	RS422_RX-	IN	

8	NC/+5V/+12V	PWR	+5V/+12V
9	GND	GND	

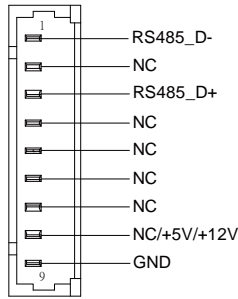

### RS-485

Pin	Pin Name	Signal Type	Signal Level
1	RS485_D-	I/O	±5V
2	NC		
3	RS485_D+	I/O	±5V
4	NC		
5	NC		
6	NC		
7	NC		
8	NC/+5V/+12V	PWR	+5V/+12V
9	GND	GND	

\* COM2 RS232/422/485 can be set by BIOS settings. Default is RS-232

\* Function for pin 8 can be set by JP2



### 2.6.16 BIOS Debug Port (CN16)

---

Pin	Pin Name	Signal type	Signal Level
1	SPI_MISO	OUT	
2	GND	GND	
3	SPI_CLK	IN	
4	+3.3VSB	PWR	+3.3V
5	SPI_MOSI	IN	
6	SPI_CS	IN	
7	NC		

### 2.6.17 MiniCard Slot (Full-MiniCard) (CN17)

---

Pin	Pin Name	Signal Type	Signal Level
1	PCIE_WAKE#	IN	
2	+3.3VSB	PWR	+3.3V
3	NC		
4	GND	GND	
5	NC		
6	+1.5V	PWR	+1.5V
7	PCIE_CLK_REQ#	IN	
8	UIM_PWR	PWR	
9	GND	GND	
10	UIM_DATA	I/O	
11	PCIE_REF_CLK-	DIFF	
12	UIM_CLK	IN	
13	PCIE_REF_CLK+	DIFF	

14	UIM_RST	IN	
15	GND	GND	
16	UIM_VPP	PWR	
17	NC		
18	GND	GND	
19	NC		
20	W_DISABLE#	OUT	+3.3V
21	GND	GND	
22	PCIE_RST#	OUT	+3.3V
23	PCIE_RX-	DIFF	
24	+3.3VSB	PWR	+3.3V
25	PCIE_RX+	DIFF	
26	GND	GND	
27	GND	GND	
28	+1.5V	PWR	+1.5V
29	GND	GND	
30	SMB_CLK	I/O	+3.3V
31	PCIE_TX-	DIFF	
32	SMB_DATA	I/O	+3.3V
33	PCIE_TX+	DIFF	
34	GND	GND	
35	GND	GND	
36	USB_D-	DIFF	
37	GND	GND	
38	USB_D+	DIFF	
39	+3.3VSB	PWR	+3.3V
40	GND	GND	

41	+3.3VSB	PWR	+3.3V
42	NC		
43	GND	GND	
44	NC		
45	NC		
46	NC		
47	NC		
48	+1.5V	PWR	+1.5V
49	NC		
50	GND	GND	
51	NC		
52	+3.3VSB	PWR	+3.3V

### 2.6.18 USB 2.0 Port 3 (CN18)

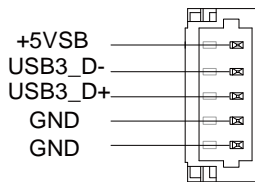

Pin	Pin Name	Signal Type	Signal Level
1	+5VSB	PWR	+5V
2	USB3_D-	DIFF	
3	USB3_D+	DIFF	
4	GND	GND	
5	GND	GND	

### 2.6.19 USB 2.0 Port 2 (CN19)

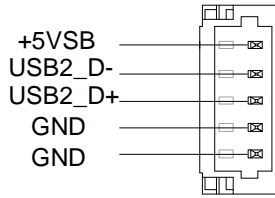

Pin	Pin Name	Signal Type	Signal Level
1	+5VSB	PWR	+5V
2	USB2_D-	DIFF	
3	USB2_D+	DIFF	
4	GND	GND	
5	GND	GND	

### 2.6.20 LVDS Port (CN21)

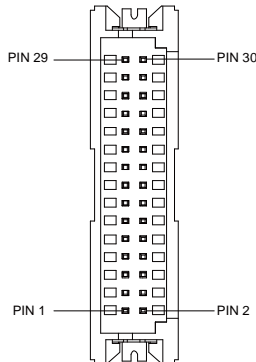

\* LVDS LCD\_PWR can be set to 3.3V or +5V by JP3

Pin	Pin Name	Signal Type	Signal Level
1	BKL_ENABLE	OUT	
2	BKL_CONTROL	OUT	

3	LCD_PWR	PWR	+3.3V/+5V
4	GND	GND	
5	LVDS_A_CLK-	DIFF	
6	LVDS_A_CLK+	DIFF	
7	LCD_PWR	PWR	+3.3V/+5V
8	GND	GND	
9	LVDS_DA0-	DIFF	
10	LVDS_DA0+	DIFF	
11	LVDS_DA1-	DIFF	
12	LVDS_DA1+	DIFF	
13	LVDS_DA2-	DIFF	
14	LVDS_DA2+	DIFF	
15	LVDS_DA3-	DIFF	
16	LVDS_DA3+	DIFF	
17	DDC_DATA	I/O	+3.3V
18	DDC_CLK	I/O	+3.3V
19	LVDS_DB0-	DIFF	
20	LVDS_DB0+	DIFF	
21	LVDS_DB1-	DIFF	
22	LVDS_DB1+	DIFF	
23	LVDS_DB2-	DIFF	
24	LVDS_DB2+	DIFF	
25	LVDS_DB3-	DIFF	
26	LVDS_DB3+	DIFF	
27	LCD_PWR	PWR	+3.3V/+5V
28	GND	GND	
29	LVDS_B_CLK-	DIFF	

30	LVDS_B_CLK+	DIFF
----	-------------	------

### 2.6.21 PS/2 Keyboard/ Mouse Combo Port (CN22)

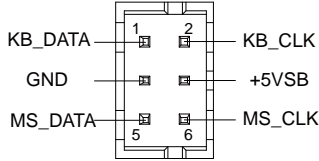

Pin	Pin Name	Signal Type	Signal Level
1	KB_DATA	I/O	+5V
2	KB_CLK	I/O	+5V
3	GND	GND	
4	+5VSB	PWR	+5V
5	MS_DATA	I/O	+5V
6	MS_CLK	I/O	+5V

### 2.6.22 Touch Screen Connector (CN23)

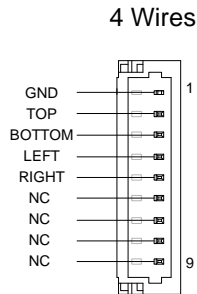

#### 4 Wire

Pin	Pin Name	Signal Type	Signal Level
1	GND	GND	

2	TOP	IN
3	BOTTOM	IN
4	LEFT	IN
5	RIGHT	IN
6	NC	
7	NC	
8	NC	
9	NC	

### 5 Wires

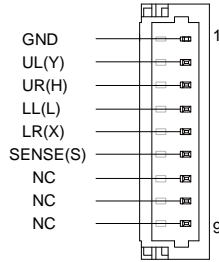

### 5 Wires

Pin	Pin Name	Signal Type	Signal Level
1	GND	GND	
2	UL(Y)	IN	
3	UR(H)	IN	
4	LL(L)	IN	
5	LR(X)	IN	
6	SENSE(S)	IN	
7	NC		
8	NC		
9	NC		

## 8 Wires

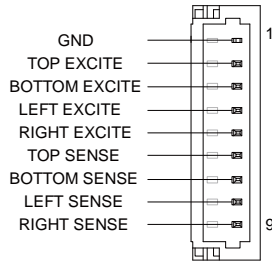

## 8 Wires

Pin	Pin Name	Signal Type	Signal Level
1	GND	GND	
2	TOP EXCITE	IN	
3	BOTTOM EXCITE	IN	
4	LEFT EXCITE	IN	
5	RIGHT EXCITE	IN	
6	TOP SENSE	IN	
7	BOTTOM SENSE	IN	
8	LEFT SENSE	IN	
9	RIGHT SENSE	IN	

\* Touch mode can be set by JP9

## 2.6.23 LVDS Port Inverter/ Backlight Connector (CN24)

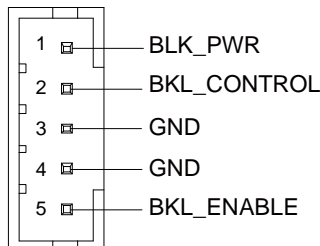



Pin	Pin Name	Signal Type	Signal Level
1	BKL_PWR	PWR	+5V / +12V
2	BKL_CONTROL	OUT	
3	GND	GND	
4	GND	GND	
5	BKL_ENABLE	OUT	+5V

\* LVDS BKL\_PWR can be set to +5V or +12V by JP4

\* LVDS BKL\_CONTROL can be set by JP5

### 2.6.24 CPU FAN (CN25)

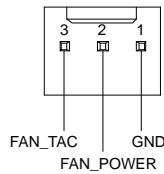

Pin	Pin Name	Signal Type	Signal Level
1	GND	GND	
2	FAN_POWER	PWR	+12V
3	FAN_TAC	IN	

### 2.6.25 LAN (RJ-45) Port 2 (CN26)

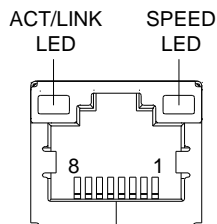

Pin	Pin Name	Signal Type	Signal Level
1	MDI0+	DIFF	
2	MDI0-	DIFF	
3	MDI1+	DIFF	
4	MDI2+	DIFF	
5	MDI2-	DIFF	
6	MDI1-	DIFF	
7	MDI3+	DIFF	
8	MDI3-	DIFF	

### 2.6.26 LAN (RJ-45) Port 1 (CN27)

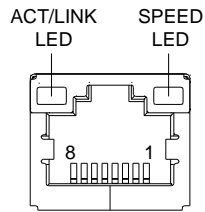

Pin	Pin Name	Signal Type	Signal Level
1	MDI0+	DIFF	
2	MDI0-	DIFF	
3	MDI1+	DIFF	
4	MDI2+	DIFF	
5	MDI2-	DIFF	
6	MDI1-	DIFF	
7	MDI3+	DIFF	
8	MDI3-	DIFF	

## 2.6.27 USB Port 0 and 1 (CN28)

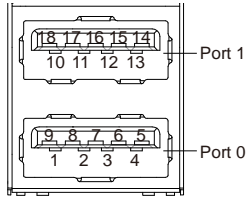

Pin	Pin Name	Signal Type	Signal Level
1	+5VSB	PWR	+5V
2	USB0_D-	DIFF	
3	USB0_D+	DIFF	
4	GND	GND	
5	USB0_SSRX-	DIFF	
6	USB0_SSRX+	DIFF	
7	GND	GND	
8	USB0_SSTX-	DIFF	
9	USB0_SSTX+	DIFF	
10	+5VSB	PWR	+5V
11	USB1_D-	DIFF	
12	USB1_D+	DIFF	
13	GND	GND	

\* Only Port 0 supports USB 3.0

## 2.6.28 DP Port (CN29)

Pin	Pin Name	Signal Type	Signal Level
1	DP_D0+	DIFF	
2	GND	GND	

3	DP_D0-	DIFF	
4	DP_D1+	DIFF	
5	GND	GND	
6	DP_D1-	DIFF	
7	DP_D2+	DIFF	
8	GND	GND	
9	DP_D2-	DIFF	
10	DP_D3+	DIFF	
11	GND	GND	
12	DP_D3-	DIFF	
13	GND	GND	
14	GND	GND	
15	DP_AUX+	DIFF	
16	GND	GND	
17	DP_AUX-	DIFF	
18	HPLG_DETECT	IN	
19	GND	GND	
20	+5V	I/O	+5V

### 2.6.30 COM Port 1 (D-SUB 9) (CN30)

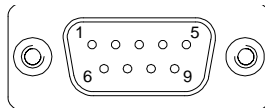

Pin	Pin Name	Signal Type	Signal Level
1	DCD	IN	
2	RX	IN	
3	TX	OUT	±9V

4	DTR	OUT	±9V
5	GND	GND	
6	DSR	IN	
7	RTS	OUT	±9V
8	CTS	IN	
9	RI	IN	

\* COM port 1 can be selected for D-SUB 9 or Wafer Box Connector by CN20

### 2.6.30 HDMI Port (CN31)

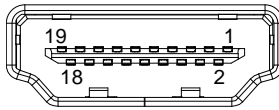

Pin	Pin Name	Signal Type	Signal Level
1	TMDS_DAT2+	DIFF	
2	GND	GND	
3	TMDS_DAT2-	DIFF	
4	TMDS_DAT1+	DIFF	
5	GND	GND	
6	TMDS_DAT1-	DIFF	
7	TMDS_DAT0+	DIFF	
8	GND	GND	
9	TMDS_DAT0-	DIFF	
10	TMDS_CLK+	DIFF	
11	GND	GND	
12	TMDS_CLK-	DIFF	
13	NC		
14	NC		

15	DDC_CLK	I/O	+5V
16	DDC_DATA	I/O	+5V
17	GND	GND	
18	+5V	I/O	+5V
19	HPLG_DETECT	IN	

### 2.6.31 Battery (CN32)

Pin	Pin Name	Signal Type	Signal Level
1	+3.3V	PWR	3.3V
2	GND	GND	

### 2.6.32 VGA Port (CN33)

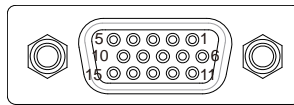

Pin	Pin Name	Signal Type	Signal Level
1	RED	OUT	
2	GREEN	OUT	
3	BLUE	OUT	
4	NC		
5	GND	GND	
6	RED_GND_RTN	GND	
7	GREEN_GND_RTN	GND	
8	BLUE_GND_RTN	GND	
9	+5V	PWR	+5V

10	CRT_PLUG#		
11	NC		
12	DDC_DATA	I/O	+5V
13	HSYNC	OUT	
14	VSYNC	OUT	
15	DDC_CLK	I/O	+5V

# Chapter 3

---

AMI BIOS Setup



## 3.1 System Test and Initialization

---

The board uses certain routines to perform testing and initialization. If an error, fatal or non-fatal, is encountered, a few short beeps or an error message will be outputted. The board can usually continue the boot up sequence with non-fatal errors.

The system configuration verification routines check the current system configuration against the values stored in the CMOS memory. If they do not match, an error message will be outputted, in which case you will need to run the BIOS setup program to set the configuration information in memory.

There are three situations in which you will need to change the CMOS settings:

- You are starting your system for the first time
- You have changed your system's hardware
- The CMOS memory has lost power and the configuration information is erased

The system's CMOS memory uses a backup battery for data retention, which is to be replaced once emptied.

## 3.2 AMI BIOS Setup

---

The AMI BIOS ROM has a pre-installed Setup program that allows users to modify basic system configurations, which is stored in the battery-backed CMOS RAM and BIOS NVRAM so that the information is retained when the power is turned off.

To enter BIOS Setup, press <Del> or <F2> immediately while your computer is powering up.

The function for each interface can be found below.

**Main** – Date and time can be set here. Press <Tab> to switch between date elements

**Advanced** – Enable/ Disable boot option for legacy network devices

**Chipset** – For hosting bridge parameters

**Boot** – Enable/ Disable quiet Boot Option

**Security** – The setup administrator password can be set here

**Save & Exit** – Save your changes and exit the program

### 3.3 Setup submenu: Main

Press '*Delete*' Key to enter Setup

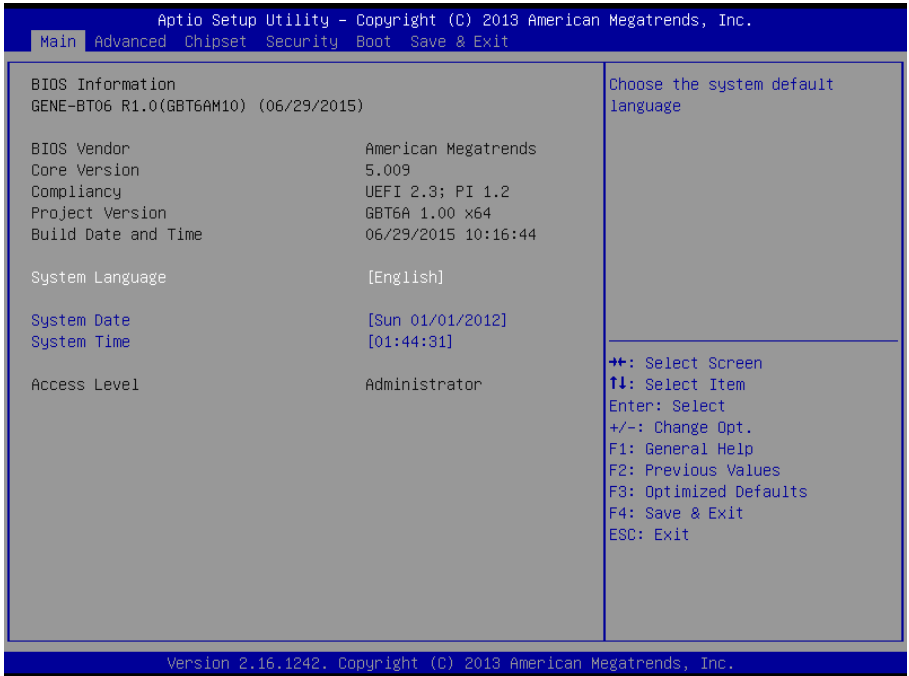

### 3.4 Setup submenu: Advanced

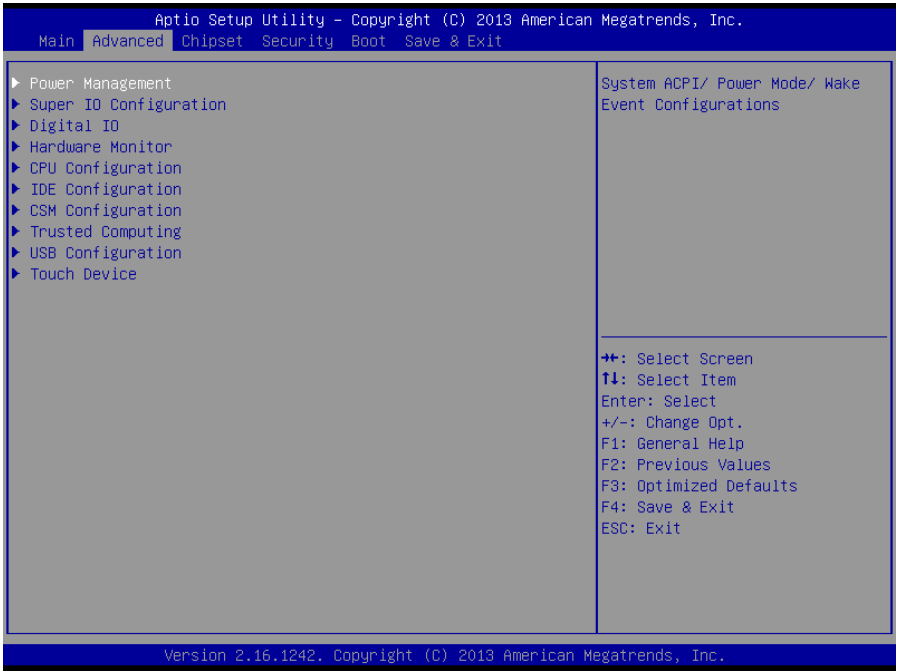

### 3.4.1 Advanced: Power Management

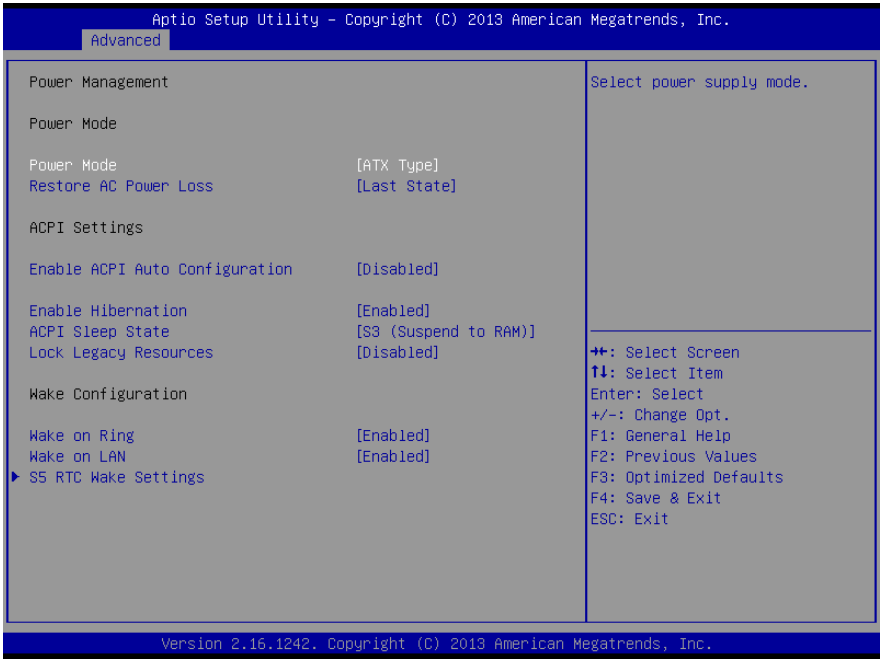

Options summary:

Power Mode	ATX Type	Optimal Default, Failsafe Default
	AT Type	
Select power supply mode		
Restore AC Power Loss	Power Off	Optimal Default, Failsafe Default
	Power On	
	Last State	
Select AC power state when power is re-applied after a power failure		
Enable ACPI Auto Configuration	Enable	Optimal Default, Failsafe Default
	Disable	
Enables or Disables BIOS ACPI Auto Configuration		

Enable Hibernation	Enable	Optimal Default, Failsafe Default
	Disable	
Enables or Disables System ability to Hibernate (OS/S4 Sleep State). This option may be not effective with some OS		
ACPI Sleep State	Suspend Disabled	Optimal Default, Failsafe Default
	S3 only(Suspend to RAM)	
Select highest ACPI sleep state the System will enter when the Suspend button is pressed		
Lock Legacy Resources	Enable	Optimal Default, Failsafe Default
	Disable	
Enables or Disables Lock of Legacy Resources		
Wake on Ring	Enable	Optimal Default, Failsafe Default
	Disable	
Enabled/Disabled wake from Ring		
Wake on LAN	Enable	Optimal Default, Failsafe Default
	Disable	
Enabled/Disabled wake from LAN		
S5 RTC Wake Settings		
Enable system to wake from S5 using RTC alarm.		

### 3.4.1.1 Power Management: S5 RTC Wake Settings

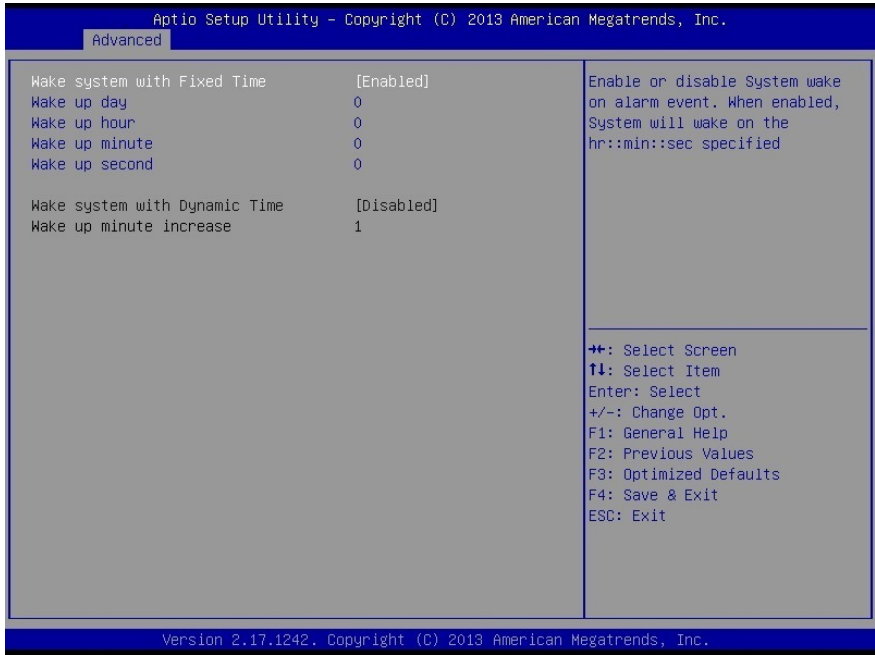

Options summary:

Wake system with Fixed Time	Enable	
	Disable	Optimal Default, Failsafe Default
Enable or disable System wake on alarm event. Wake up time is setting by following settings.		
Wake up day	0-31	
Select 0 for daily system wake up 1-31 for which day of the month that you would like the system to wake up		
Wake up hour	0-23	
Wake up minute	0-59	
Wake up second	0-59	

Wake system with Dynamic Time	Enable	
	Disable	Optimal Default, Failsafe Default
Enable or disable System wake on alarm event. Wake up time is current time + Increase minutes.		
Wake up minute increase	1-15	



### 3.4.2 Advanced: Super IO Configuration

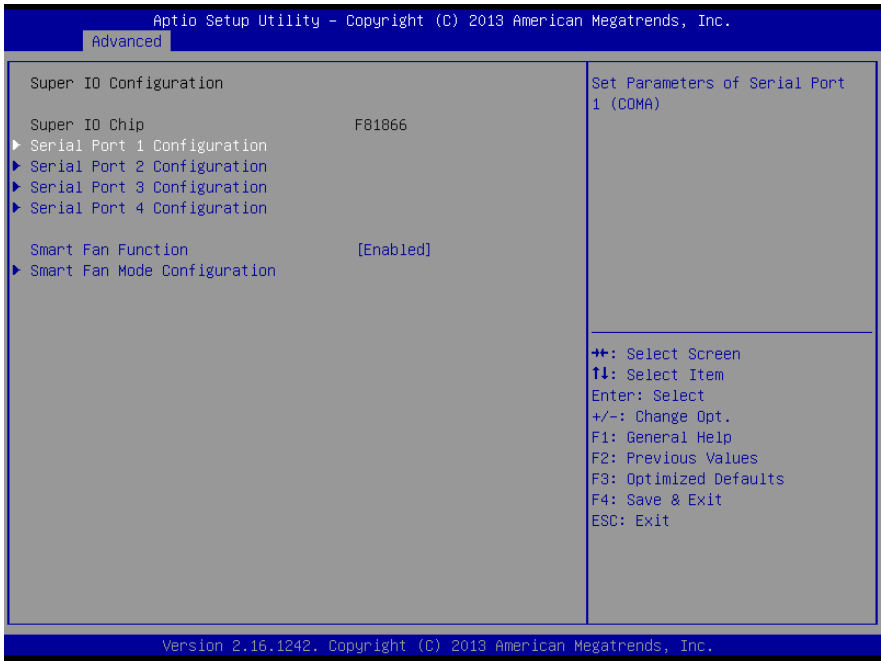

### 3.4.2.1 Super IO Configuration: Serial Port 1 Configuration

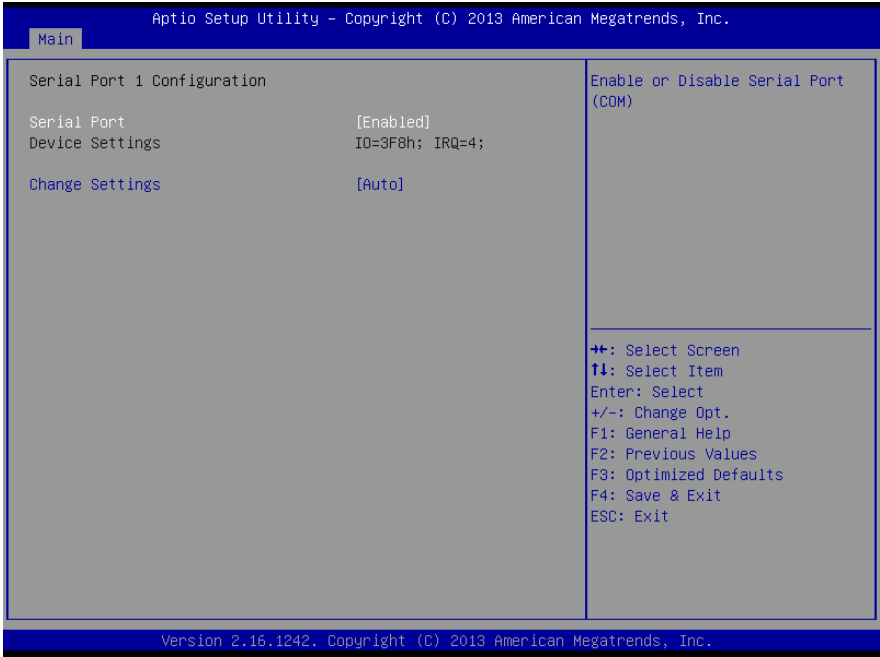

### 3.4.2.2 Super IO Configuration: Serial Port 2 Configuration

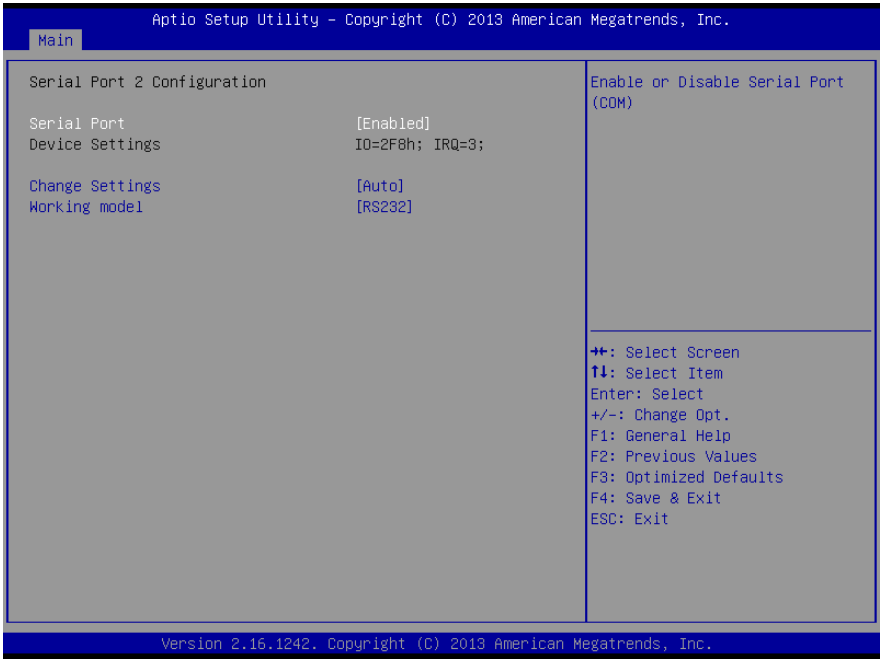

### 3.4.2.3 Super IO Configuration: Serial Port 3 Configuration

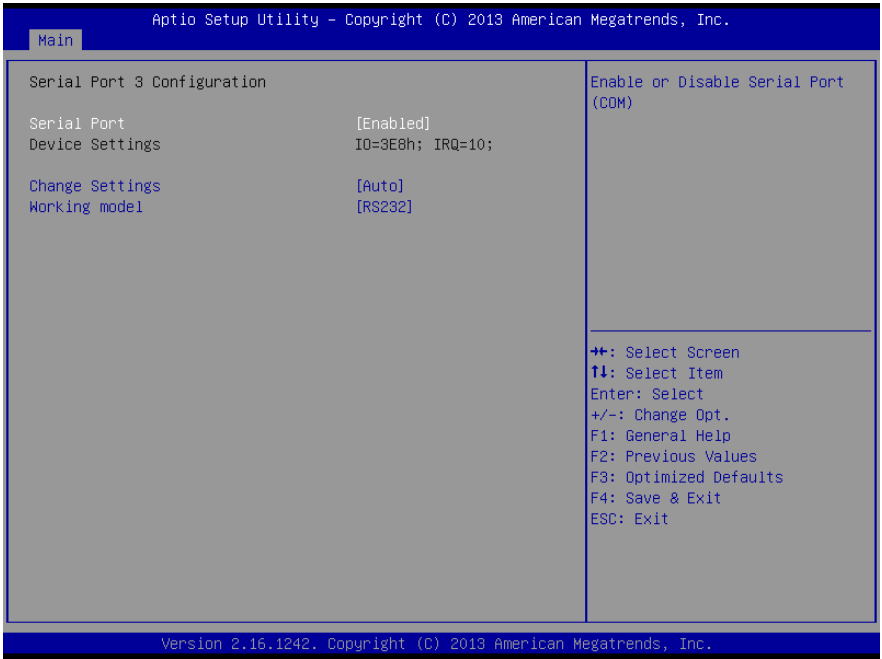

### 3.4.2.4 Super IO Configuration: Serial Port 4 Configuration

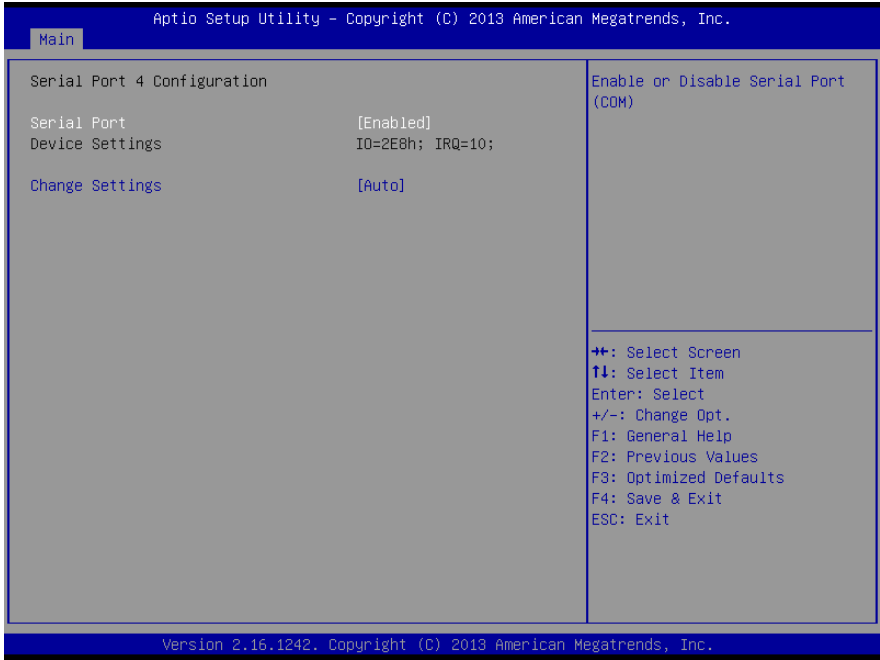

Options summary:

Serial Port	Disabled	
	Enabled	Default
Allows BIOS to En/Disable correspond serial port.		
Change Settings (Serial Port 1)	Auto	Default
	IO=3F8h; IRQ=4;	
	IO=3F8h; IRQ=3,4,5,6,7,9,10,11,12;	
	IO=2F8h; IRQ=3,4,5,6,7,9,10,11,12;	
	IO=2F8h; IRQ=3,4,5,6,7,9,10,11,12;	

	IO=3E8h; IRQ=3,4,5,6,7,9,10,11,12;			
	IO=2E8h; IRQ=3,4,5,6,7,9,10,11,12;			
Allows BIOS to Select Serial Port resource.				
Change Settings (Serial Port 2)	Auto	Default		
	IO=2F8h; IRQ=3;			
	IO=3F8h; IRQ=3,4,5,6,7,9,10,11,12;			
	IO=2F8h; IRQ=3,4,5,6,7,9,10,11,12;			
	IO=3E8h; IRQ=3,4,5,6,7,9,10,11,12;			
	IO=2E8h; IRQ=3,4,5,6,7,9,10,11,12;			
	Working model		RS232	Default
			RS422	
	RS485			
Select Working model				
Change Settings (Serial Port 3)	Auto	Default		
	IO=3E8h; IRQ=7;			
	IO=3F8h; IRQ=3,4,5,6,7,9,10,11,12;			
	IO=2F8h; IRQ=3,4,5,6,7,9,10,11,12;			
	IO=3E8h; IRQ=3,4,5,6,7,9,10,11,12;			
	IO=2E8h; IRQ=3,4,5,6,7,9,10,11,12;			

	IO=2E8h; IRQ=3,4,5,6,7,9,10,11,12;	
	IO=2F0h; IRQ=3,4,5,6,7,9,10,11,12;	
	IO=2E0h; IRQ=3,4,5,6,7,9,10,11,12;	
Working model	RS232	Default
	RS422	
	RS485	
Select Working model		
Change Settings (Serial Port 4)	Auto	Default
	IO=2E8h; IRQ=7;	
	IO=3F8h; IRQ=3,4,5,6,7,9,10,11,12;	
	IO=2F8h; IRQ=3,4,5,6,7,9,10,11,12;	
	IO=3E8h; IRQ=3,4,5,6,7,9,10,11,12;	
	IO=2E8h; IRQ=3,4,5,6,7,9,10,11,12;	
	IO=2F0h; IRQ=3,4,5,6,7,9,10,11,12;	
	IO=2E0h; IRQ=3,4,5,6,7,9,10,11,12;	

### 3.4.2.5 Super IO Configuration: Smart Fan Function

---

Options summary:

Smart Fan Function	Disabled	Optimal Default, Failsafe Default
	Enabled	
Enabled or Disabled Smart Fan		



### 3.4.2.6 Super IO Configuration: Smart Fan Mode Configuration

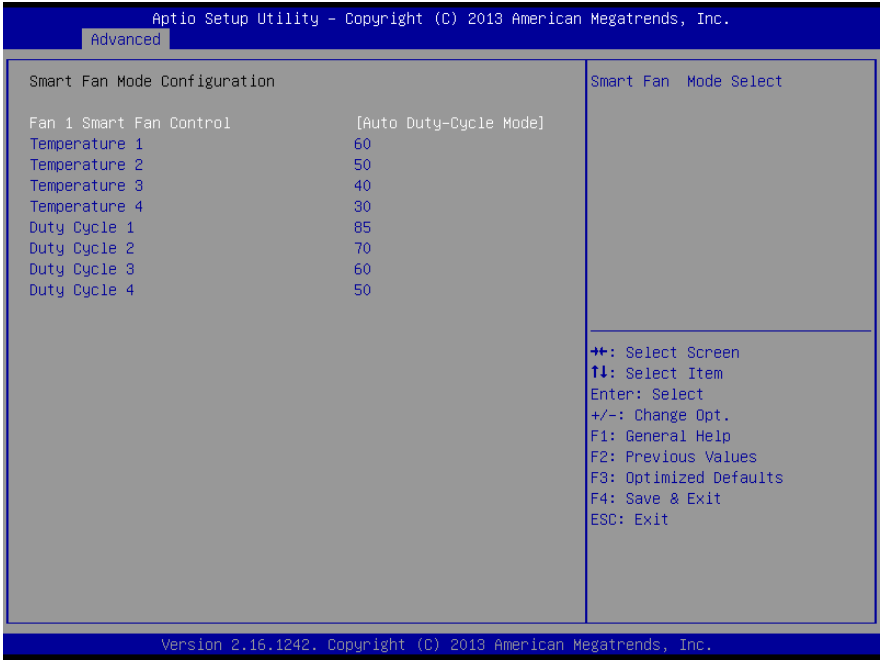

Options summary:

Fan 1 Smart Fan Control	Manual RPM Mode	
	Manual Duty Mode	
	Auto RPM Mode	
	Auto Duty-Cycle Mode	Optimal Default, Failsafe Default
Smart Fan Mode Select		

### 3.4.3 Advanced: Digital IO

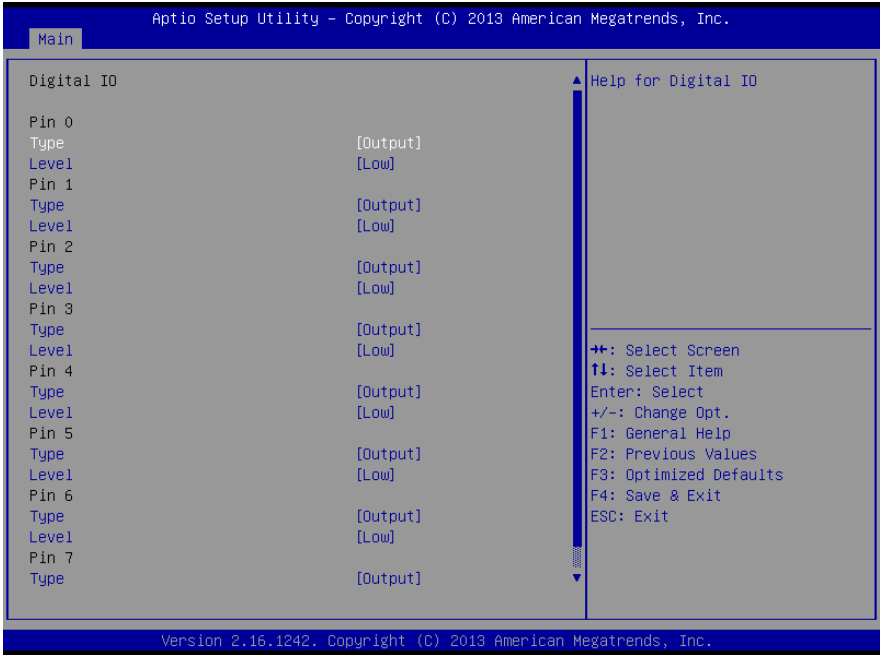

Options summary:

Pin 0~7	Input	Optimal Default, Failsafe Default
	Output	
Set DIO Port 0~7 as Input or Output		
Output Level	Low	Optimal Default, Failsafe Default
	Hi	
Set GPIO Level when used as Output		

### 3.4.4 Advanced: H/W Monitor

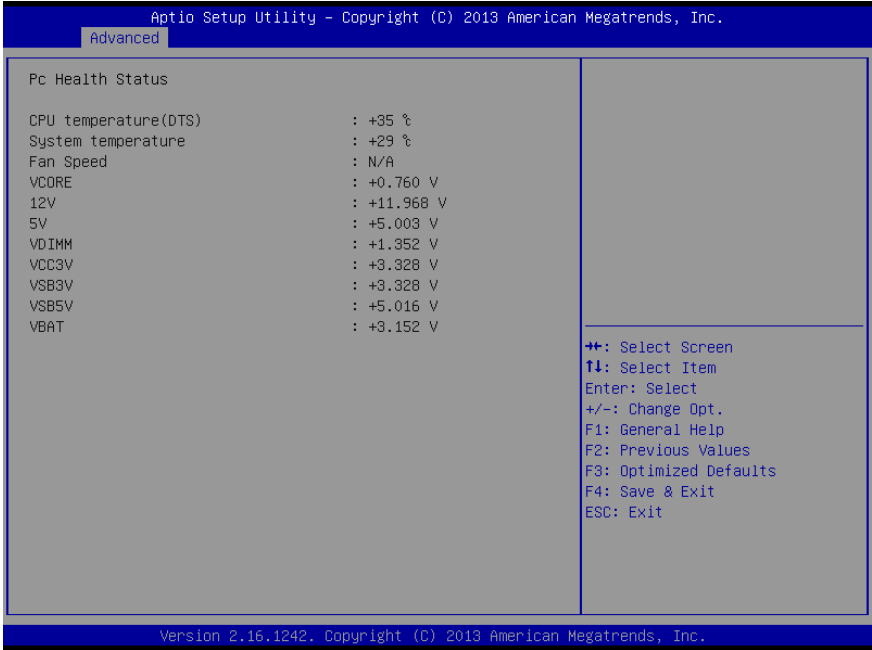

### 3.4.4 Advanced: CPU Configuration

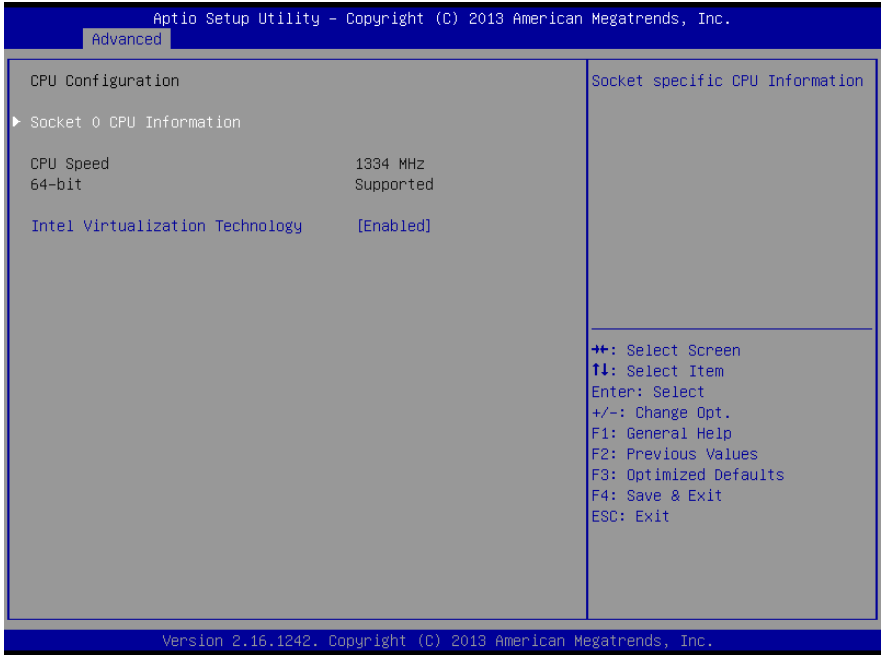

Options summary:

Intel Virtualization	Disabled	Optimal Default, Failsafe Default
Technology	Enabled	
When enabled, a VMM can utilize the additional hardware capabilities provided by Vander pool Technology		

### 3.4.4.1 CPU Configuration: Socket 0 CPU Information

Aptio Setup Utility - Copyright (C) 2013 American Megatrends, Inc.

Main

Socket 0 CPU Information

Intel(R) Atom(TM) CPU E3825 @ 1.33GHz	
CPU Signature	30679
Microcode Patch	901
Max CPU Speed	1330 MHz
Min CPU Speed	533 MHz
Processor Cores	2
Intel HT Technology	Not Supported
Intel VT-x Technology	Supported
L1 Data Cache	24 kB x 2
L1 Code Cache	32 kB x 2
L2 Cache	1024 kB x 1
L3 Cache	Not Present

→+: Select Screen  
↑↓: Select Item  
Enter: Select  
+/-: Change Opt.  
F1: General Help  
F2: Previous Values  
F3: Optimized Defaults  
F4: Save & Exit  
ESC: Exit

Version 2.16.1242. Copyright (C) 2013 American Megatrends, Inc.

### 3.4.5 Advanced: IDE Configuration

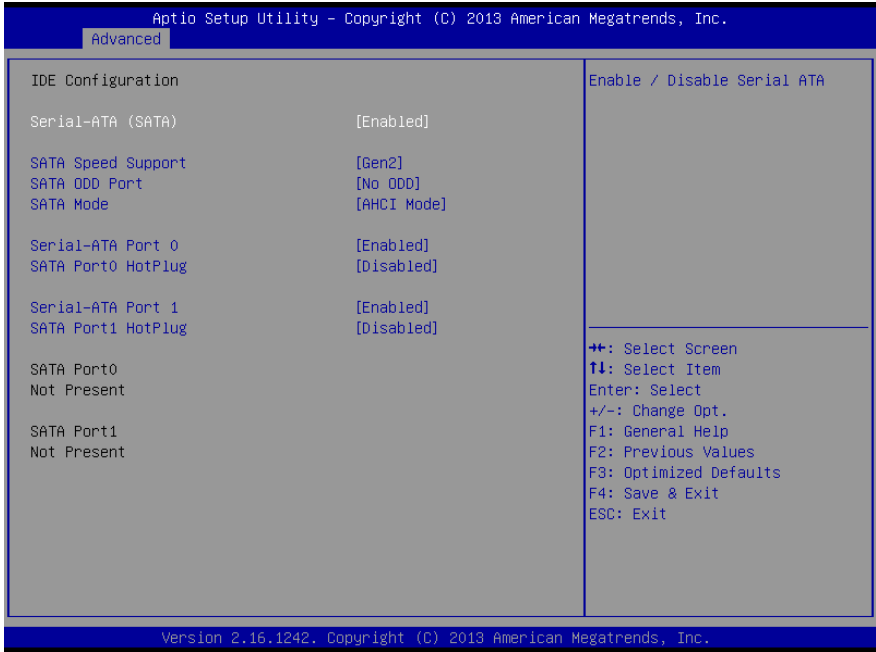

Options summary:

Serial-ATA(SATA)	Enabled	Default
	Disable	
SATA Speed Support	Gen1	
	Gen2	Default
SATA ODD Port	Port0 ODD	
	Port1 ODD	
	No ODD	Default
SATA Mode	IDE	
	AHCI	Default

IDE: Configure SATA controllers as legacy IDE		
AHCI: Configure SATA controllers to operate in AHCI mode		
Serial-ATA Port0/1	Enabled	Default
	Disable	
SATA Port0/1 HotPlug	Enabled	
	Disable	Default

### 3.4.6 Advanced: CSM Configuration

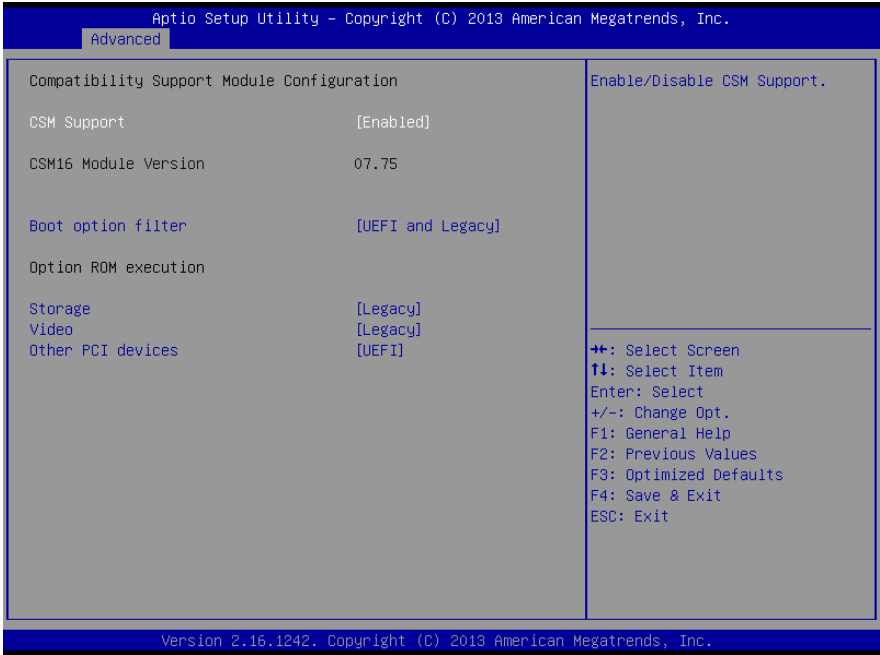

Options summary:

CSM Support	Disable	Default
	Enabled	
Boot option filter	UEFI and Legacy	Default
	Legacy only	
	UEFI only	
Storage & Video	Do not launch	Default
	UEFI	
	Legacy	
Other PCI devices	UEFI	Default
	Legacy	



### 3.4.7 Advanced: Trusted Computing

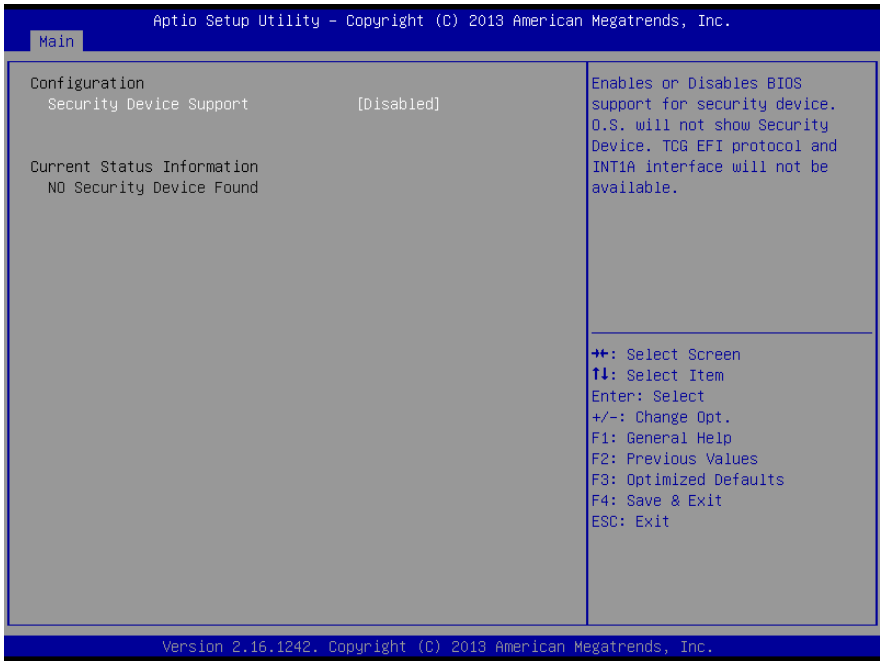

Options summary:

Security Device Support	Enabled	Optimal Default, Failsafe Default
	Disabled	
Enabled or Disabled BIOS Support for Security device. O.S. will not show Security Device. TCG EFI protocol and INT1A interface will not be available		

### 3.4.8 Advanced: USB Configuration

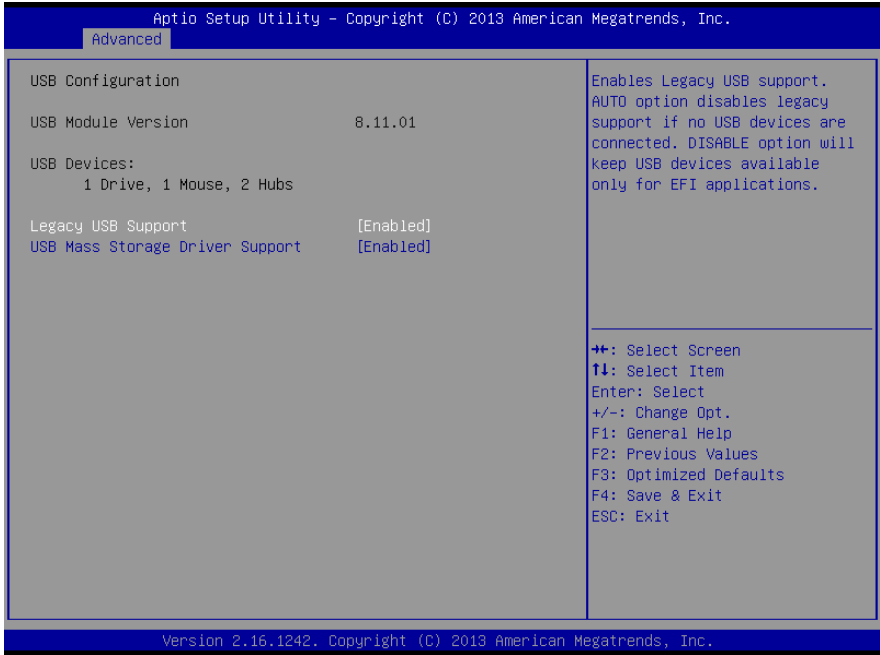

Options summary:

Legacy USB Support	Enabled	Optimal Default, Failsafe Default
	Disabled	
	Auto	
Enables BIOS Support for Legacy USB Support. When enabled, USB can be functional in legacy environment like DOS.		
AUTO option disables legacy support if no USB devices are connected		
USB Mass Storage Driver Support	Disabled	Optimal Default, Failsafe Default
	Enabled	
Enable/Disable USB Mass Storage Driver Support		
Device Name (Emulation	Auto	Optimal Default, Failsafe Default

Type)	Floppy	
	Forced FDD	
	Hard Disk	
	CDROM	
If Auto. USB devices less than 530MB will be emulated as Floppy and remaining as Floppy and remaining as hard drive. Forced FDD option can be used to force a HDD formatted drive to boot as FDD(Ex. ZIP drive)		

### 3.4.9 Advanced: Touch Device

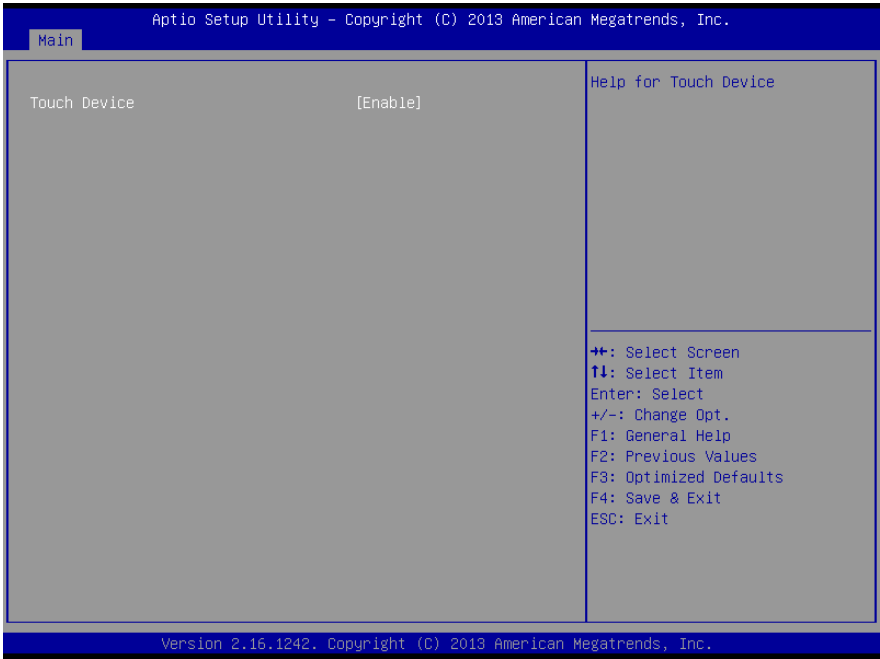

Options summary:

Touch Device	Disable	Default
	Enable	
Help for Touch Device		

### 3.5 Setup submenu: Chipset

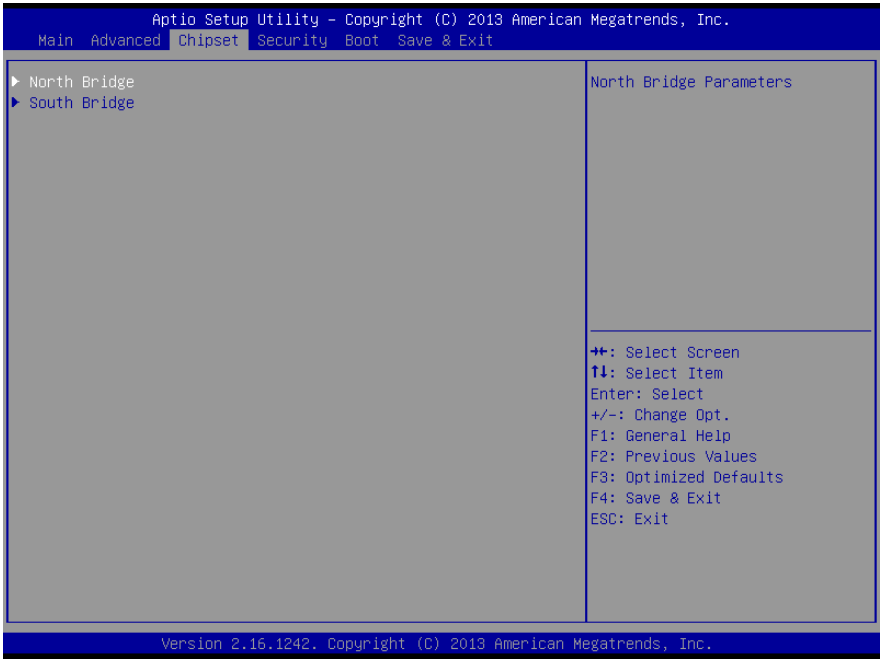

### 3.5.1 Chipset: Host Bridge

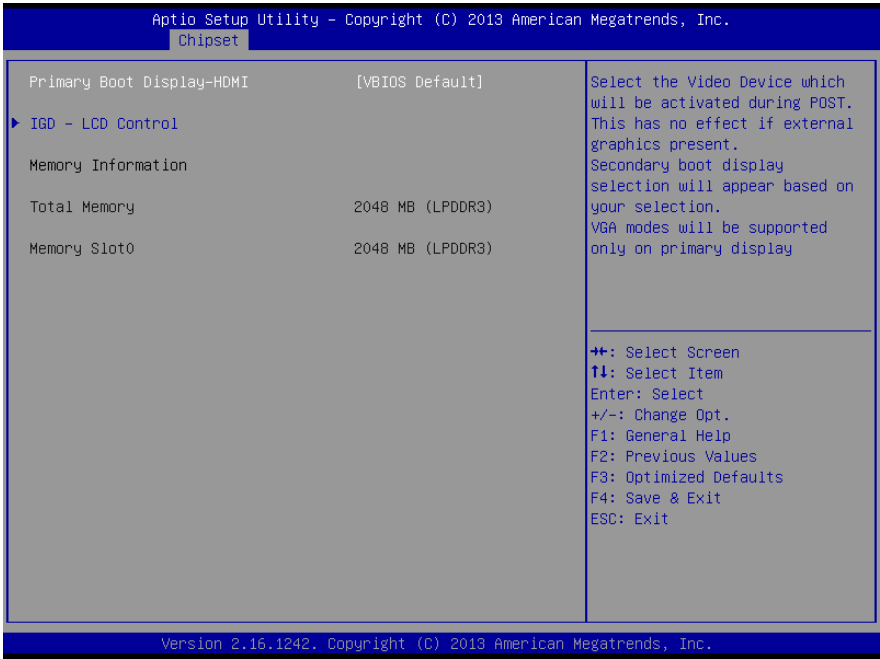

Options summary:

Primary Boot Display	VBIOS Default	Default
	CRT	
	DP/HDMI	
	LVDS	

### 3.5.1.1 Host Bridge: IGD - LCD Control

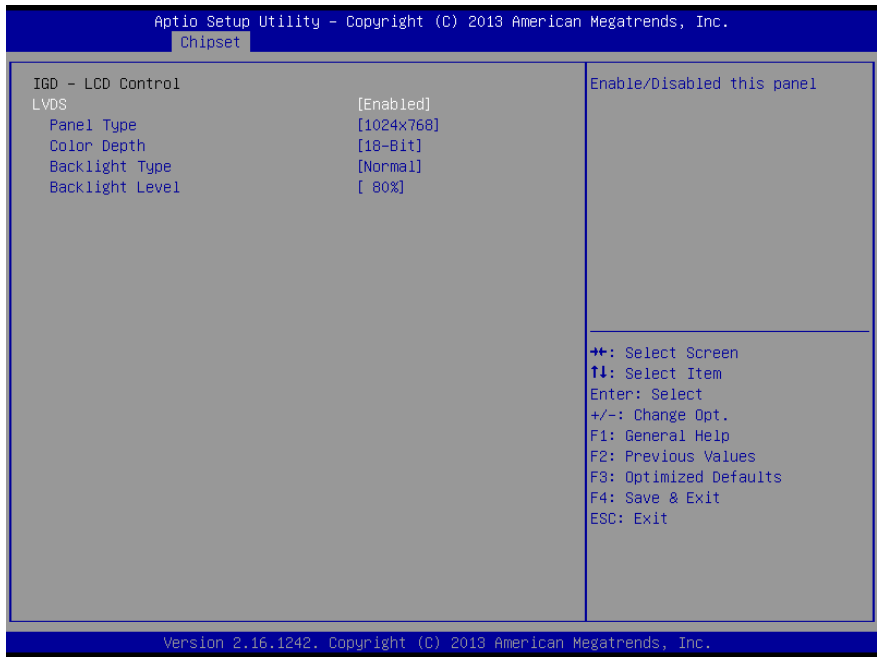

Options summary:

LVDS	Disabled	
	Enabled	Default
Enable or Disable LVDS interface		
Panel Type	640x480	Default
	800x480	
	800x600	
	1024x600	
	1024x768	
	1280x768	
	1280x1024	
	1366x768	

	1440x900	
	1600x1200	
	1920x1080	
	1920x1200	
Select panel resolution.		
Color Depth	18-Bit	Default
	24-Bit	
	36-Bit	
	48-Bit	
Select color depth of the panel		
Backlight Type	Normal	Default
	Inverted	
Select Backlight control type.		
Inverted: Brightest for low PWM duty cycle and low voltage.		
Normal: Brightest for high PWM duty cycle and high voltage.		
Backlight Level	0%	Default
	10%	
	20%	
	30%	
	40%	
	50%	
	60%	
	70%	
	80%	
	90%	
	100%	
Select Backlight Level		



## 3.5.2 Chipset: South Bridge

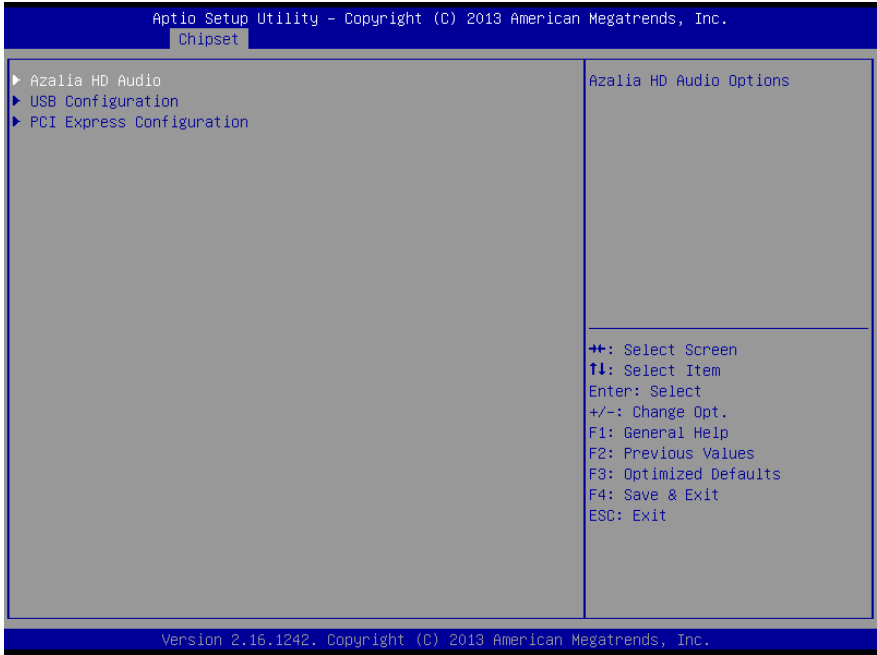

### 3.5.2.1 South Bridge: Azalia HD Audio

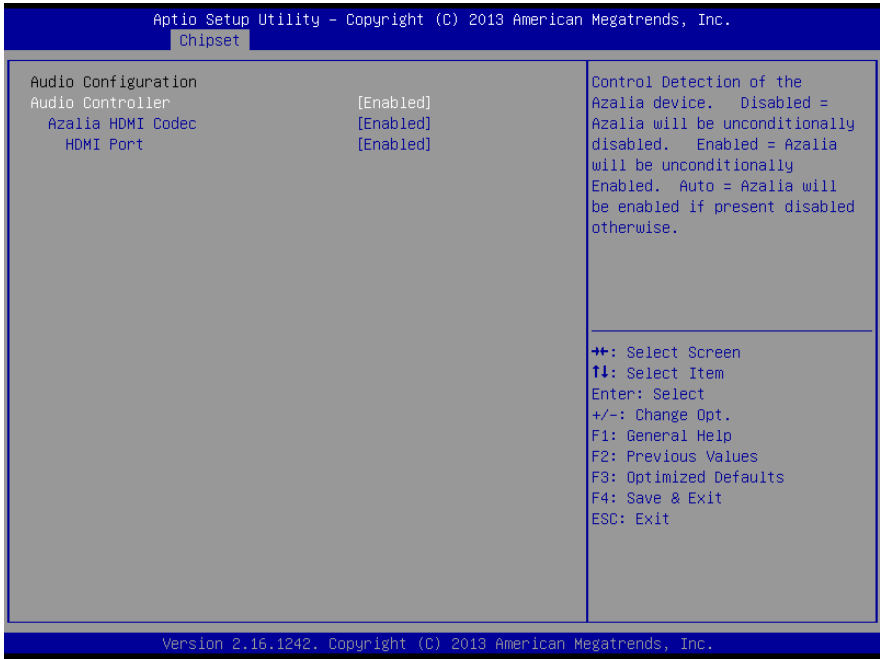

Options summary:

Audio Controller	Disabled	Default
	Enabled	
Control Detection of the Azalia device.		
Disabled = Azalia will be unconditionally disabled.		
Enabled = Azalia will be unconditionally Enabled.		
Auto = Azalia will be enabled if present disabled otherwise.		
Azalia HDMI codec	Disabled	Default
	Enabled	
Enable/Disable internal HDMI codec for Azalia		
HDMI Port	Disabled	

	Enabled	Default
Enable/Disable HDMI Port		

### 3.5.2.2 South Bridge: USB Configuration

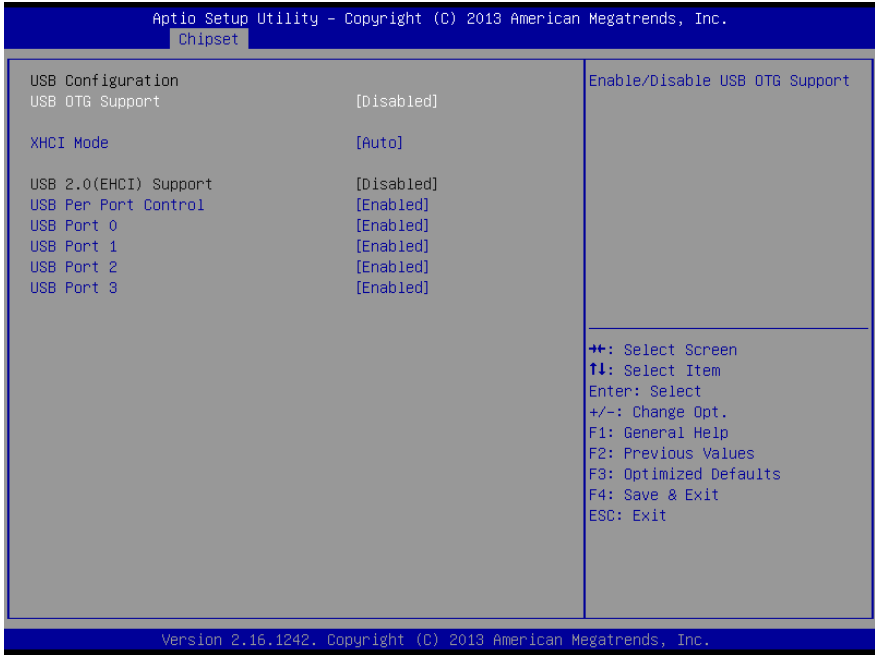

Options summary:

USB OTG Support	PCI mode	Default
	Disabled	
Enable/Disable USB OTG Support		
XHCI Mode	Enabled	Default
	Disabled	
	Auto	
	Smart Auto	
Mode of operation of XHCI controller		
USB Per Port Control	Enabled	Default
	Disabled	

Control each of the USB ports (0~3).		
Enable: Enable USB per port		
Disable: Use USB port X settings		
USB Port0/1/2/3	Enabled	Default
	Disabled	
Enable/Disable USB Port0/1/2/3		

### 3.5.2.3 South Bridge: PCI Express Configuration

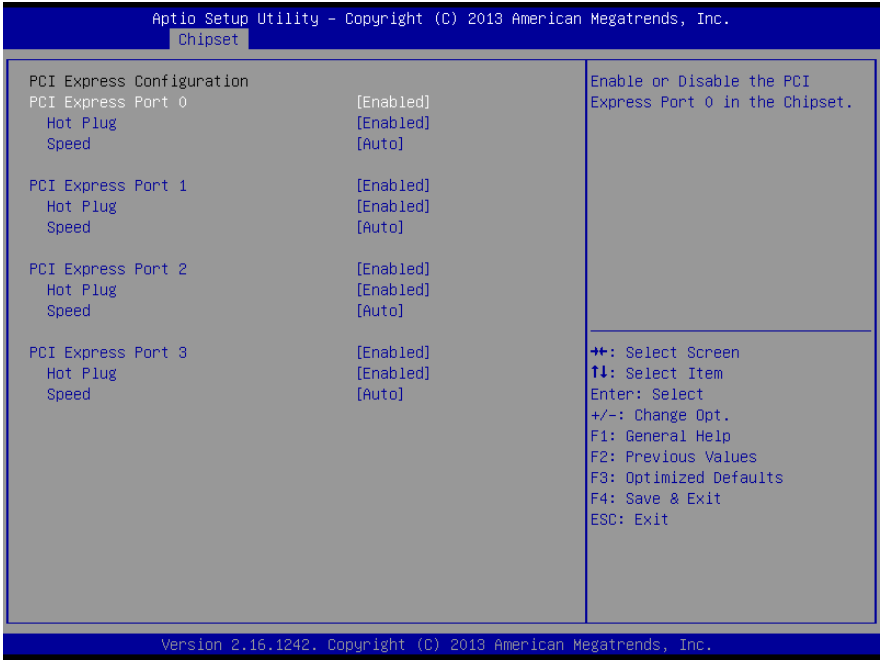

Options summary:

PCI Express Root Port 0/1/2/3	Enabled	Optimal Default, Failsafe Default
	Disabled	
Enabling/Disabling the PCI Express root ports		
Hot Plug	Disabled	Default
	Enabled	
Enabling/Disabling the PCI Express Hot Plug		
Speed	Auto	Default
	Gen2	
	Gen1	
Configure PCIe Port Speed		

## 3.6 Setup submenu: Security

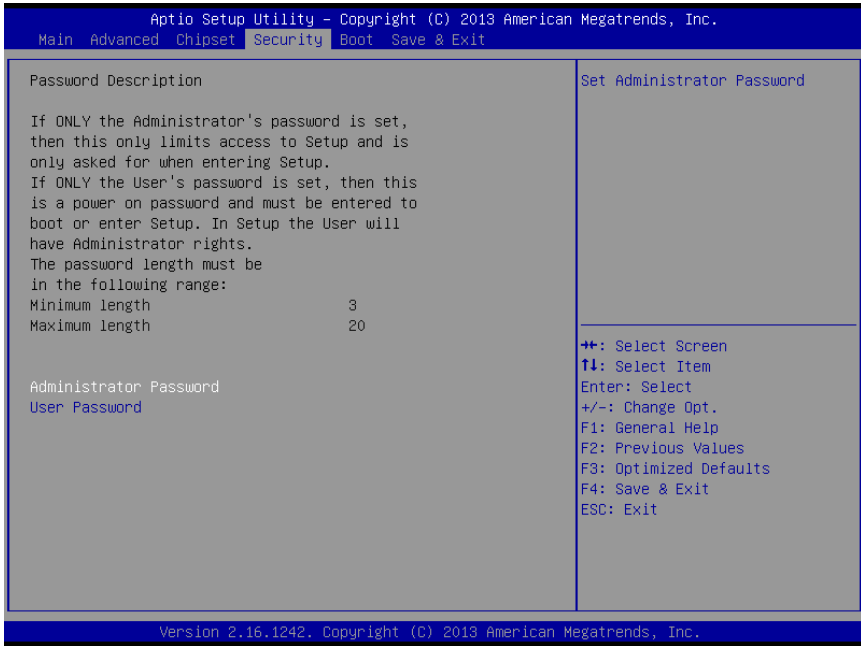

### Change User/Administrator Password

You can set a User Password once an Administrator Password is set. The password will be required during boot up, or when the user enters the Setup utility. Please Note that a User Password does not provide access to many of the features in the Setup utility.

Select the password you wish to set, press Enter to open a dialog box to enter your password (you can enter no more than six letters or numbers). Press Enter to confirm your entry, after which you will be prompted to retype your password for a final confirmation. Press Enter again after you have retyped it correctly.

## Removing the Password

Highlight this item and type in the current password. At the next dialog box press Enter to disable password protection.



### 3.7 Setup submenu: Boot

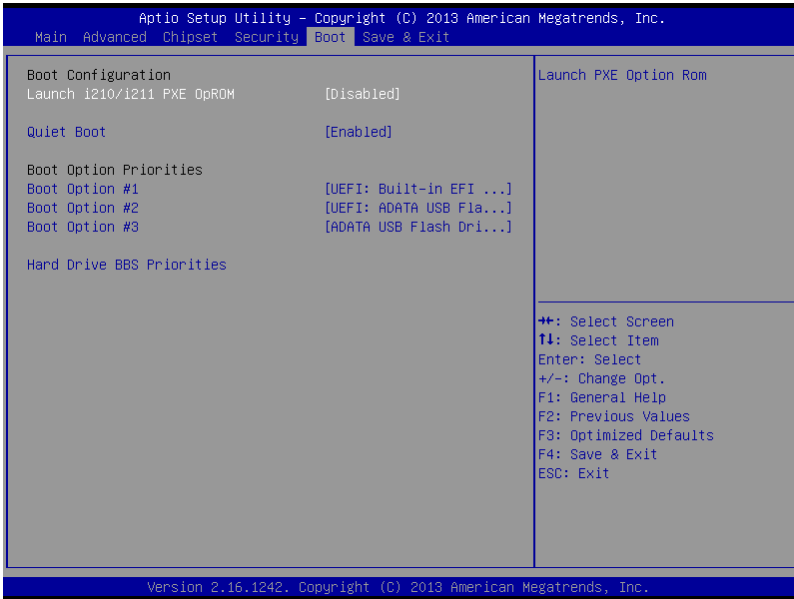

Options summary:

Launch i210/i211 PXE	Disabled	Default
OpROM	Enabled	
Launch PXE Option Rom		
Quiet Boot	Disabled	Default
	Enabled	
En/Disables Quiet Boot option		

### 3.8 Setup submenu: Exit

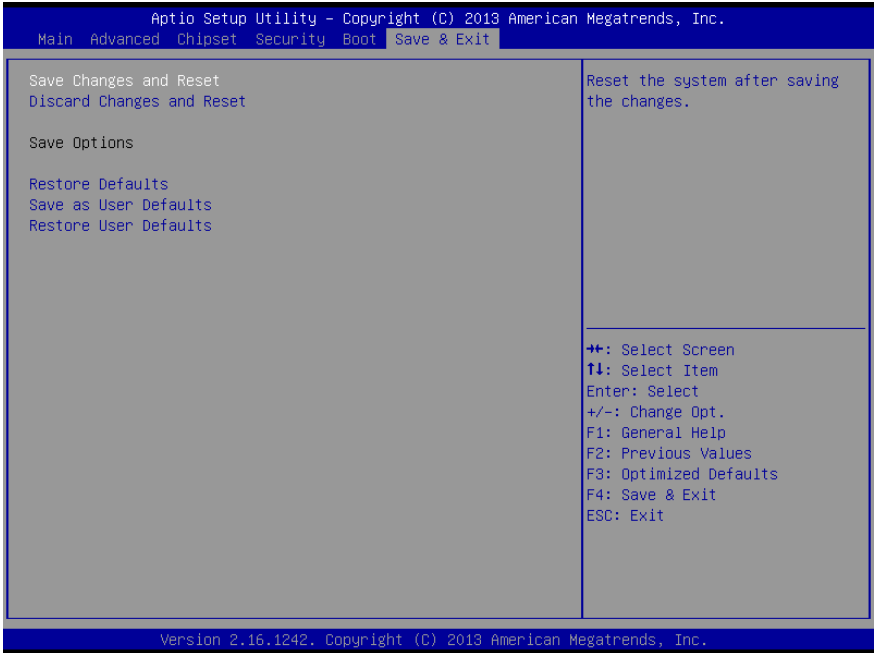

# Chapter 4

---

Drivers Installation

## 4.1 Product CD/DVD

---

The GENE-BT06 comes with a product DVD that contains all the drivers and utilities you need to setup your product. Insert the DVD and follow the steps in the autorun program to install the drivers.

In case the program does not start, follow the sequence below to install the drivers.

### Step 1 – Install Chipset Driver

1. Open the **Step 1 - Chipset** folder and select your OS
2. Open the **SetupChipset.exe** in the folder
3. Follow the instructions
4. Drivers will be installed automatically

### Step 2 – Install Graphics Driver

1. Open the **Step 2 - Graphics** folder and select your OS
2. Open the **Setup.exe** file in the folder
3. Follow the instructions
4. Drivers will be installed automatically

### Step 3 – Install LAN Driver

1. Click on the **Step 3 - LAN** folder and select your OS
2. Open the **.exe** file in the folder
3. Follow the instructions
4. Drivers will be installed automatically

#### Step 4 – Install Audio Driver

1. Open the **Step 4 - Audio** folder and select your OS
2. Open the **.exe** file in the folder
3. Follow the instructions
4. Drivers will be installed automatically

#### Step 5 – Install TXE Driver (Windows 8.1/10 only)

1. Open the **Step 5 – TXE Device** folder and select your OS
2. Open the **SetupTXE.exe** file in the folder
3. Follow the instructions
4. Drivers will be installed automatically

#### Step 6 – Install PenMount Touch 6000 Driver

1. Open the **Step 6 – PenMount Touch 6000** folder and select your OS
2. Open the **Setup.exe file** in the folder
3. Follow the instructions
4. Drivers will be installed automatically

#### Step 7 – Install TPM Driver

1. Open the **Step 7 - TPM** folder followed by **Atmel TPM Driver Installer 3.0.3.15.exe**
2. Follow the instructions
3. Drivers will be installed automatically

#### Step 8 – Install MBI Driver (Optional, Windows 8.1/10 only)

1. Open the **Step 8 – MBI (Optional)** folder and select your OS
2. Open the **Setup.exe** file in the folder
3. Follow the instructions
4. Drivers will be installed automatically

### Step 9 – Install USB 3.0 Driver (Windows 7 only)

1. Open the **Step 9 – USB 3.0** folder followed by **Setup.exe**
2. Follow the instructions
3. Drivers will be installed automatically

### Step 10 – Install Serial Port Driver (Optional)

For Windows 7:

1. Change User Account Control settings to **Never notify**

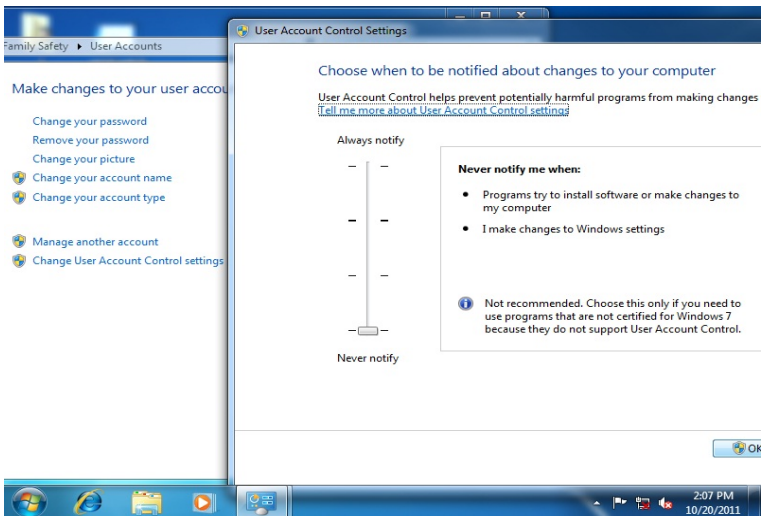

2. Reboot and log in as administrator

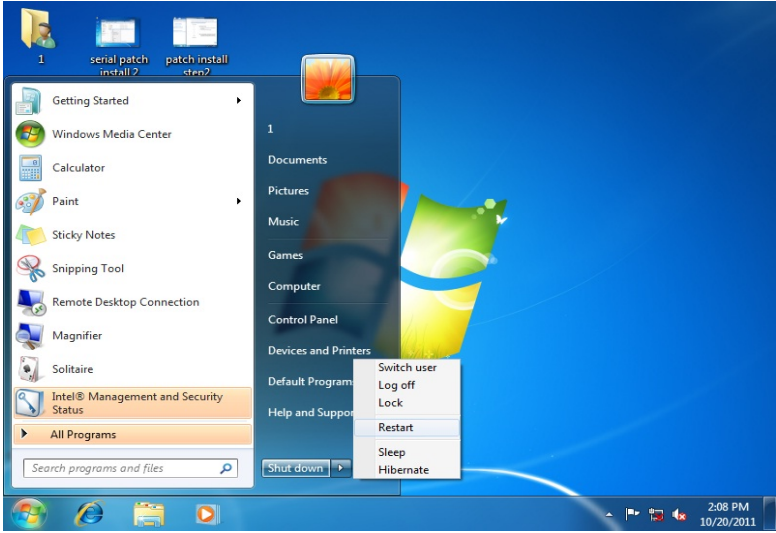

3. Run patch.bat as administrator

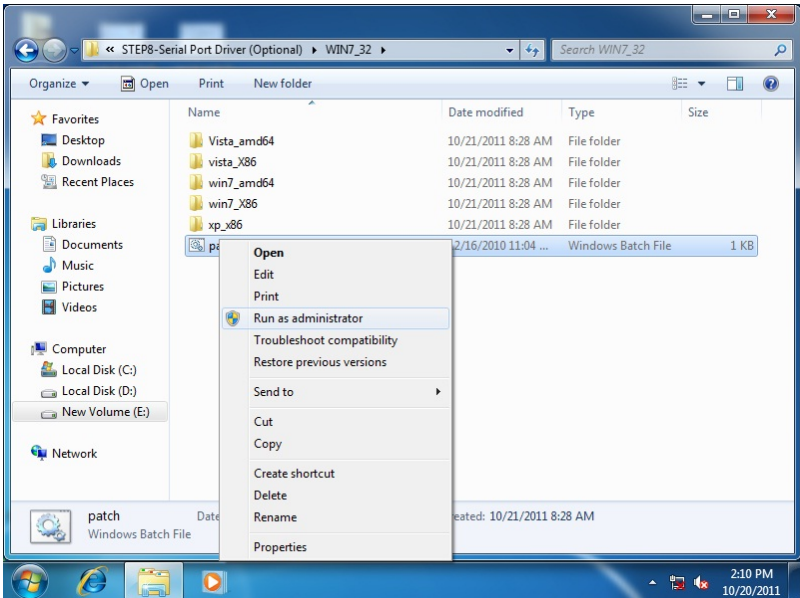

## For Windows 8:

1. Open the Apps Screen, right click on the **Command Prompt** tile and select **Run as Administrator**

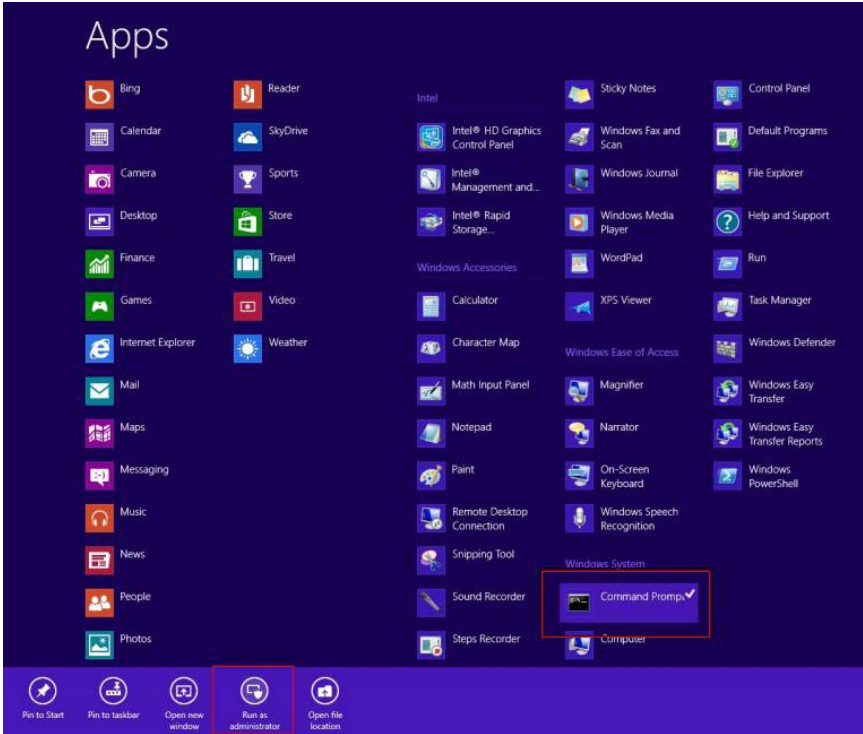

2. To install the driver (patch.bat), you will first have to locate the file in command prompt. To do that, go to the folder in which the file resides by entering **cd (file path)** eg: if the file is in a folder named abc in c drive, enter **cd c:\abc** (screenshot for reference only)
3. You are now at the folder where the file is located. Enter the **patch.bat** to open and install the drivers.



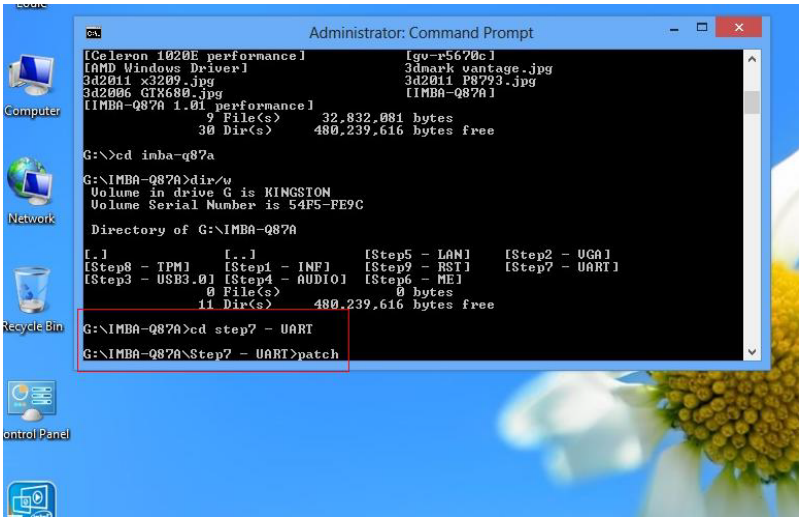

4. Reboot after installation completes.
5. To confirm the installation, go to Device Manager, expand the Ports (COM & LPT) tree and double click on any of the COM ports to open its properties. Go to the Driver tab, select Driver Details and click on **serial.sys**, you should see its provider as **Windows (R) Win 7 DDK Provider**.

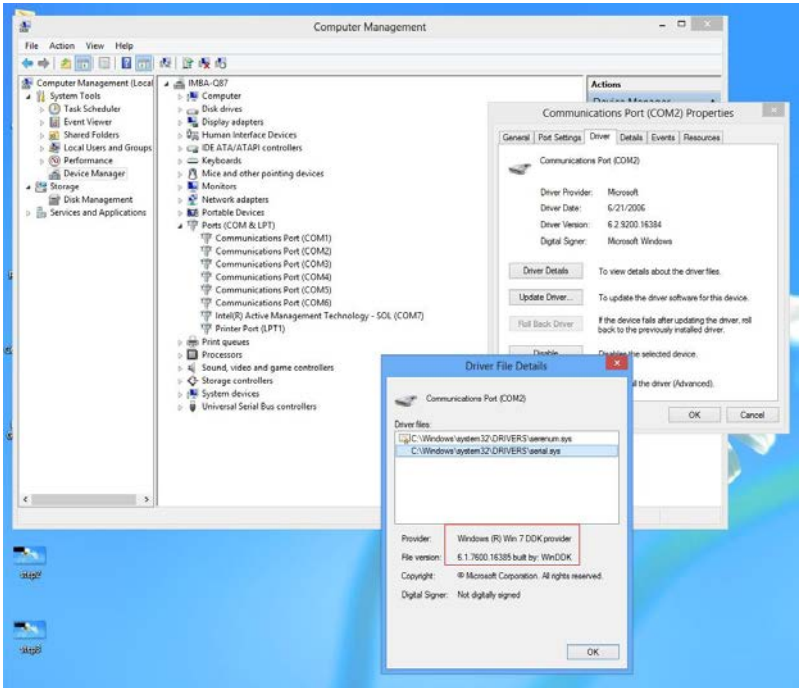

## For Windows 10:

1. You will need administrator rights to install the drivers. To get it, first go to **Computer Management** in **Control Panel** and double-click on **Administrator**

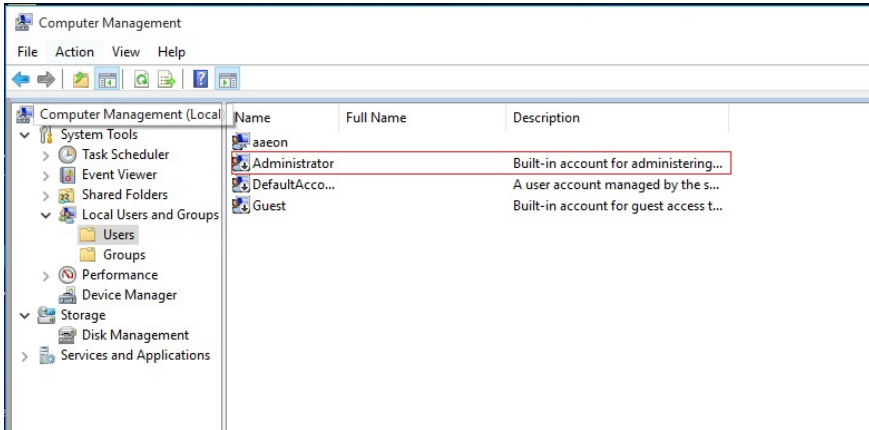

2. In the dialog box, **uncheck** the **Account is disabled** option to enable administrator account.

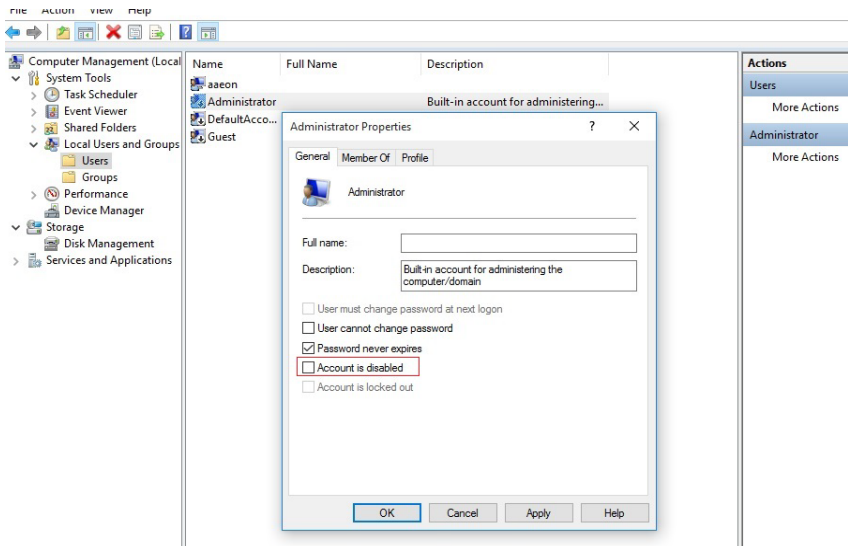

- Restart and sign in as the administrator (not password-protected by default)



- Go back to the Windows 10 Serial Port drivers directory and run `patch.bat` as administrator.

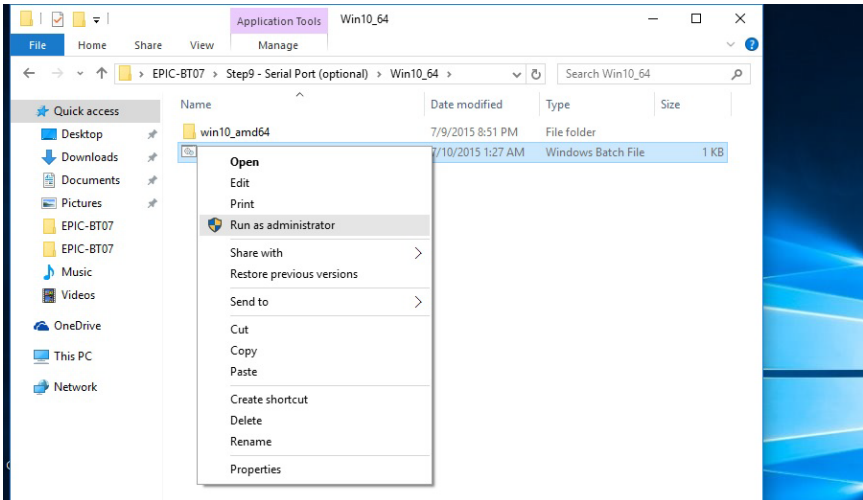

# Appendix A

---

## Watchdog Timer Programming

## A.1 Watchdog Timer Registers

Table 1 : Watch dog relative IO address

	Default Value	Note
I/O Base Address	0xA00	I/O Base address for Watchdog operation. This address is assigned by SIO LDN7, register 0x60-0x61.

Table 2 : Watchdog relative register table

Register	Offset	BitNum	Value	Note
Watchdog WDTRST# Enable	0x00	7	1	Enable/Disable time out output via WDTRST# 0: Disable 1: Enable
Pulse Width	0x05	0:1	01	Width of Pulse signal 00: 1ms (do not use) 01: 25ms 10: 125ms 11: 5s <i>Pulse width is must longer than 16ms.</i>
Signal Polarity	0x05	2	0	0: low active 1: high active <i>Must set this bit to 0</i>
Counting Unit	0x05	3	0	Select time unit. 0: second 1: minute
Output Signal	0x05	4	1	0: Level

Type				1: Pulse <i>Must set this bit to 1</i>
Watchdog Timer Enable	0x05	5	1	0: Disable 1: Enable
Timeout Status	0x05	6	1	1: timeout occurred. Write a 1 to clear timeout status
Timer Counter	0x06			Time of watchdog timer (0~255)

## A.2 Watchdog Sample Program

---

```

*****// WDT I/O
operation relative definition (Please reference to Table 1)
#define WDTAddr 0xA00 // WDT I/O base address
Void WDTWriteByte(byte Register, byte Value);
byte WDTReadByte(byte Register);
Void WDTSetReg(byte Register, byte Bit, byte Val);
// Watch Dog relative definition (Please reference to Table 2)
#define DevReg 0x00 // Device configuration register
#define WDTRstBit 0x80 // Watchdog WDTRST# (Bit7)
#define WDTRstVal 0x80 // Enabled WDTRST#
#define TimerReg 0x05 // Timer register
#define PSWidthBit 0x00 // WDTRST# Pulse width (Bit0:1)
#define PSWidthVal 0x01 // 25ms for WDTRST# pulse
#define PolarityBit 0x02 // WDTRST# Signal polarity (Bit2)
#define PolarityVal 0x00 // Low active for WDTRST#
#define UnitBit 0x03 // Unit for timer (Bit3)
#define ModeBit 0x04 // WDTRST# mode (Bit4)
#define ModeVal 0x01 // 0:level 1: pulse
#define EnableBit 0x05 // WDT timer enable (Bit5)
#define EnableVal 0x01 // 1: enable
#define StatusBit 0x06 // WDT timer status (Bit6)
#define CounterReg 0x06 // Timer counter register
*****
*****
VOID Main(){
// Procedure : AaeonWDTConfig
// (byte)Timer : Counter of WDT timer.(0x00~0xFF)

```



```

// (boolean)Unit : Select time unit(0: second, 1: minute).
AaeonWDTConfig(Counter, Unit);
// Procedure : AaeonWDTEnable
// This procedure will enable the WDT counting.
WDTSetBit(TimerReg, PSWidthBit, PSWidthVal);
// Watchdog WDRST# Enable
WDTSetBit(DevReg, WDTRstBit, WDTRstVal);
}
VOID WDTClearTimeoutStatus(){
WDTSetBit(TimerReg, StatusBit, 1);
}
*****

*****

VOID WDTWriteByte(byte Register, byte Value){
IOWriteByte(WDAddr+Register, Value);
}
byte WDTReadByte(byte Register){
return IOReadByte(WDAddr+Register);
}
VOID WDTSetBit(byte Register, byte Bit, byte Val){
byte TmpValue;
TmpValue = WDTReadByte(Register);
TmpValue &= ~(1 << Bit);
TmpValue |= Val << Bit;
WDTWriteByte(Register, TmpValue);
}
*****

```

# Appendix B







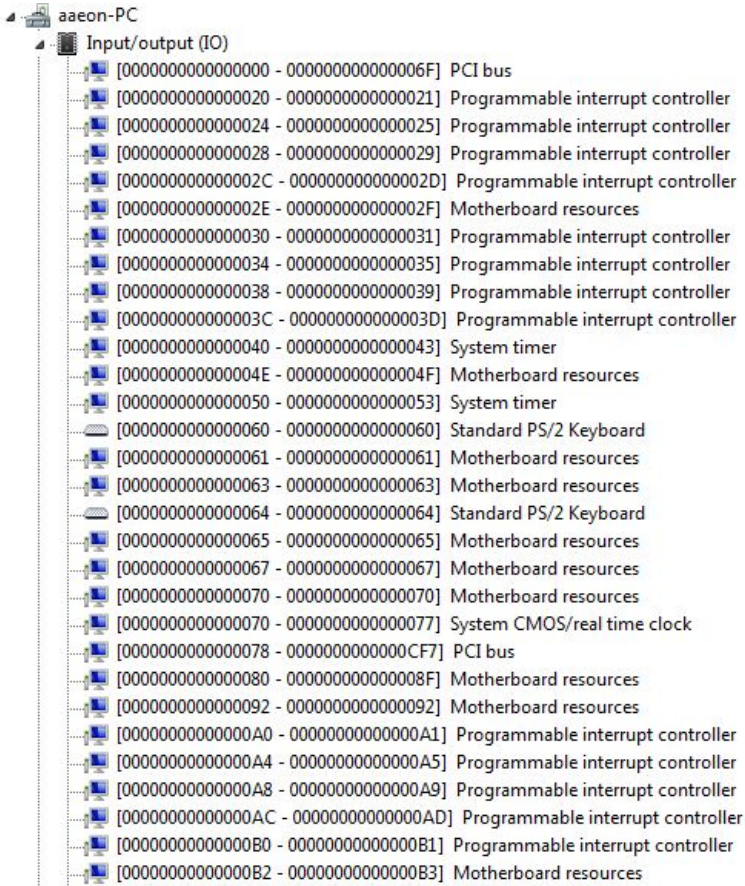





















---

I/O Information

## B.1 I/O Address Map



Address Range	Device Name
[0000000000000000 - 000000000000006F]	PCI bus
[0000000000000020 - 0000000000000021]	Programmable interrupt controller
[0000000000000024 - 0000000000000025]	Programmable interrupt controller
[0000000000000028 - 0000000000000029]	Programmable interrupt controller
[000000000000002C - 000000000000002D]	Programmable interrupt controller
[000000000000002E - 000000000000002F]	Motherboard resources
[0000000000000030 - 0000000000000031]	Programmable interrupt controller
[0000000000000034 - 0000000000000035]	Programmable interrupt controller
[0000000000000038 - 0000000000000039]	Programmable interrupt controller
[000000000000003C - 000000000000003D]	Programmable interrupt controller
[0000000000000040 - 0000000000000043]	System timer
[000000000000004E - 000000000000004F]	Motherboard resources
[0000000000000050 - 0000000000000053]	System timer
[0000000000000060 - 0000000000000060]	Standard PS/2 Keyboard
[0000000000000061 - 0000000000000061]	Motherboard resources
[0000000000000063 - 0000000000000063]	Motherboard resources
[0000000000000064 - 0000000000000064]	Standard PS/2 Keyboard
[0000000000000065 - 0000000000000065]	Motherboard resources
[0000000000000067 - 0000000000000067]	Motherboard resources
[0000000000000070 - 0000000000000070]	Motherboard resources
[0000000000000070 - 0000000000000077]	System CMOS/real time clock
[0000000000000078 - 000000000000CF7]	PCI bus
[0000000000000080 - 000000000000008F]	Motherboard resources
[0000000000000092 - 0000000000000092]	Motherboard resources
[00000000000000A0 - 00000000000000A1]	Programmable interrupt controller
[00000000000000A4 - 00000000000000A5]	Programmable interrupt controller
[00000000000000A8 - 00000000000000A9]	Programmable interrupt controller
[00000000000000AC - 00000000000000AD]	Programmable interrupt controller
[00000000000000B0 - 00000000000000B1]	Programmable interrupt controller
[00000000000000B2 - 00000000000000B3]	Motherboard resources

	[00000000000000B4 - 00000000000000B5]	Programmable interrupt controller
	[00000000000000B8 - 00000000000000B9]	Programmable interrupt controller
	[00000000000000BC - 00000000000000BD]	Programmable interrupt controller
	[00000000000002E8 - 00000000000002EF]	Communications Port (COM4)
	[00000000000002F8 - 00000000000002FF]	Communications Port (COM2)
	[00000000000003B0 - 00000000000003BB]	Intel(R) Atom(TM) Processor E3800 Series/Intel(R) Ce
	[00000000000003C0 - 00000000000003DF]	Intel(R) Atom(TM) Processor E3800 Series/Intel(R) Ce
	[00000000000003E8 - 00000000000003EF]	Communications Port (COM3)
	[00000000000003F8 - 00000000000003FF]	Communications Port (COM1)
	[0000000000000400 - 000000000000047F]	Motherboard resources
	[00000000000004D0 - 00000000000004D1]	Programmable interrupt controller
	[0000000000000500 - 00000000000005FE]	Motherboard resources
	[0000000000000600 - 000000000000061F]	Motherboard resources
	[0000000000000680 - 000000000000069F]	Motherboard resources
	[0000000000000A00 - 0000000000000A0F]	Motherboard resources
	[0000000000000A10 - 0000000000000A1F]	Motherboard resources
	[0000000000000A20 - 0000000000000A2F]	Motherboard resources
	[0000000000000D00 - 000000000000FFFF]	PCI bus
	[000000000000C000 - 000000000000CFFF]	Intel(R) Atom(TM)/Celeron(R)/Pentium(R) Processo
	[000000000000D000 - 000000000000DFFF]	Intel(R) Atom(TM)/Celeron(R)/Pentium(R) Processo
	[000000000000E000 - 000000000000E01F]	Intel(R) Atom(TM)/Celeron(R)/Pentium(R) Processor
	[000000000000E020 - 000000000000E03F]	Intel(R) Atom(TM)/Celeron(R)/Pentium(R) Processor
	[000000000000E040 - 000000000000E043]	Intel(R) Atom(TM)/Celeron(R)/Pentium(R) Processor
	[000000000000E050 - 000000000000E057]	Intel(R) Atom(TM)/Celeron(R)/Pentium(R) Processor
	[000000000000E060 - 000000000000E063]	Intel(R) Atom(TM)/Celeron(R)/Pentium(R) Processor
	[000000000000E070 - 000000000000E077]	Intel(R) Atom(TM)/Celeron(R)/Pentium(R) Processor
	[000000000000E080 - 000000000000E087]	Intel(R) Atom(TM) Processor E3800 Series/Intel(R) Cel
		Interrupt request (IRQ)

## B.2 Memory Address Map

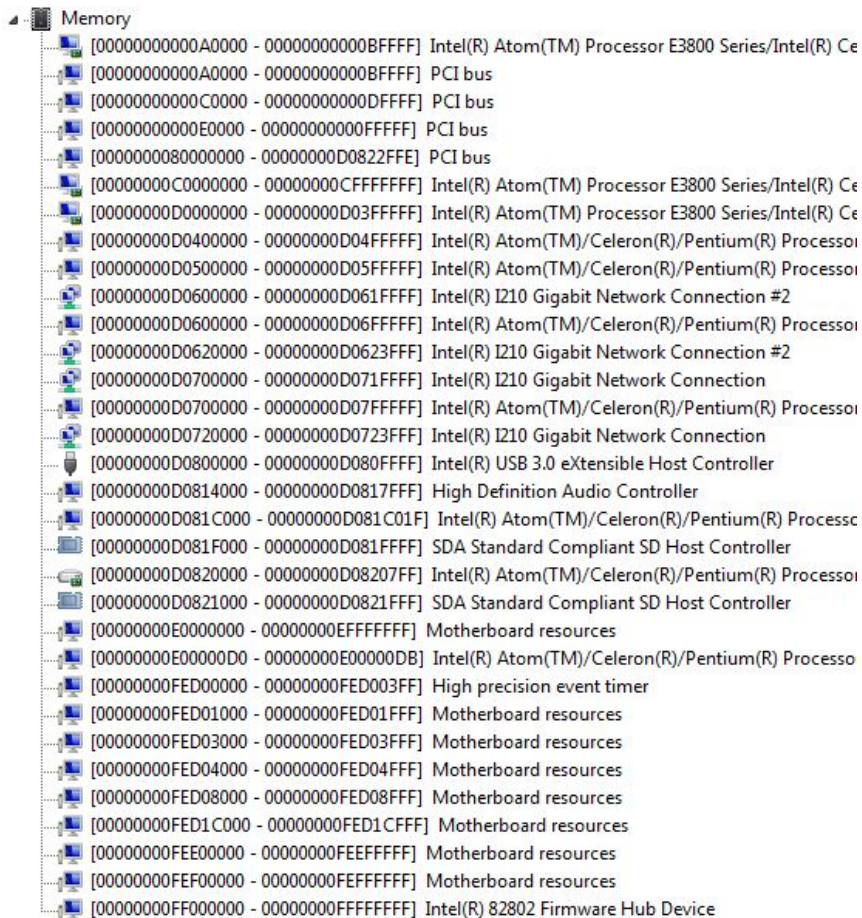





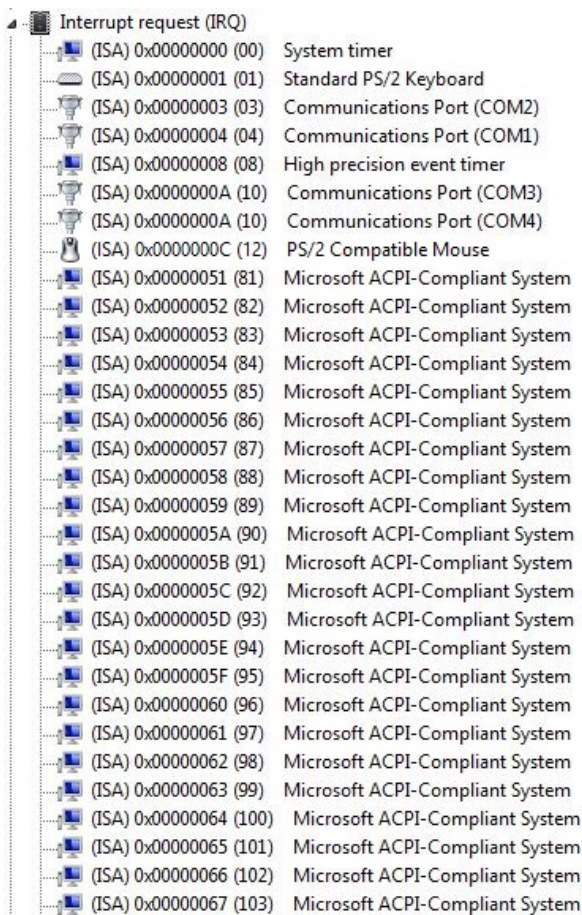



























Address Range	Device Name
[00000000000A0000 - 00000000000BFFFFF]	Intel(R) Atom(TM) Processor E3800 Series/Intel(R) Ce
[00000000000A0000 - 00000000000BFFFFF]	PCI bus
[00000000000C0000 - 00000000000DFFFFF]	PCI bus
[00000000000E0000 - 00000000000FFFFFFF]	PCI bus
[0000000080000000 - 00000000D0822FFE]	PCI bus
[00000000C0000000 - 00000000CFFFFFFF]	Intel(R) Atom(TM) Processor E3800 Series/Intel(R) Ce
[00000000D0000000 - 00000000D03FFFFFFF]	Intel(R) Atom(TM) Processor E3800 Series/Intel(R) Ce
[00000000D0400000 - 00000000D04FFFFFFF]	Intel(R) Atom(TM)/Celeron(R)/Pentium(R) Processo
[00000000D0500000 - 00000000D05FFFFFFF]	Intel(R) Atom(TM)/Celeron(R)/Pentium(R) Processo
[00000000D0600000 - 00000000D061FFFFF]	Intel(R) I210 Gigabit Network Connection #2
[00000000D0600000 - 00000000D06FFFFFFF]	Intel(R) Atom(TM)/Celeron(R)/Pentium(R) Processo
[00000000D0620000 - 00000000D0623FFF]	Intel(R) I210 Gigabit Network Connection #2
[00000000D0700000 - 00000000D071FFFFF]	Intel(R) I210 Gigabit Network Connection
[00000000D0700000 - 00000000D07FFFFFFF]	Intel(R) Atom(TM)/Celeron(R)/Pentium(R) Processo
[00000000D0720000 - 00000000D0723FFF]	Intel(R) I210 Gigabit Network Connection
[00000000D0800000 - 00000000D080FFFFF]	Intel(R) USB 3.0 eXtensible Host Controller
[00000000D0814000 - 00000000D0817FFF]	High Definition Audio Controller
[00000000D081C000 - 00000000D081C01F]	Intel(R) Atom(TM)/Celeron(R)/Pentium(R) Processo
[00000000D081F000 - 00000000D081FFFFF]	SDA Standard Compliant SD Host Controller
[00000000D0820000 - 00000000D08207FF]	Intel(R) Atom(TM)/Celeron(R)/Pentium(R) Processo
[00000000D0821000 - 00000000D0821FFF]	SDA Standard Compliant SD Host Controller
[00000000E0000000 - 00000000EFFFFFFF]	Motherboard resources
[00000000E00000D0 - 00000000E00000DB]	Intel(R) Atom(TM)/Celeron(R)/Pentium(R) Processo
[00000000FED00000 - 00000000FED003FF]	High precision event timer
[00000000FED01000 - 00000000FED01FFF]	Motherboard resources
[00000000FED03000 - 00000000FED03FFF]	Motherboard resources
[00000000FED04000 - 00000000FED04FFF]	Motherboard resources
[00000000FED08000 - 00000000FED08FFF]	Motherboard resources
[00000000FED1C000 - 00000000FED1CFFF]	Motherboard resources
[00000000FEE00000 - 00000000FEEFFFFFFF]	Motherboard resources
[00000000FEF00000 - 00000000FEFFFFFFF]	Motherboard resources
[00000000FF000000 - 00000000FFFFFFFFF]	Intel(R) 82802 Firmware Hub Device

































## B.3 IRQ Mapping Chart



Device	IRQ
System timer	(ISA) 0x00000000 (00)
Standard PS/2 Keyboard	(ISA) 0x00000001 (01)
Communications Port (COM2)	(ISA) 0x00000003 (03)
Communications Port (COM1)	(ISA) 0x00000004 (04)
High precision event timer	(ISA) 0x00000008 (08)
Communications Port (COM3)	(ISA) 0x0000000A (10)
Communications Port (COM4)	(ISA) 0x0000000A (10)
PS/2 Compatible Mouse	(ISA) 0x0000000C (12)
Microsoft ACPI-Compliant System	(ISA) 0x00000051 (81)
Microsoft ACPI-Compliant System	(ISA) 0x00000052 (82)
Microsoft ACPI-Compliant System	(ISA) 0x00000053 (83)
Microsoft ACPI-Compliant System	(ISA) 0x00000054 (84)
Microsoft ACPI-Compliant System	(ISA) 0x00000055 (85)
Microsoft ACPI-Compliant System	(ISA) 0x00000056 (86)
Microsoft ACPI-Compliant System	(ISA) 0x00000057 (87)
Microsoft ACPI-Compliant System	(ISA) 0x00000058 (88)
Microsoft ACPI-Compliant System	(ISA) 0x00000059 (89)
Microsoft ACPI-Compliant System	(ISA) 0x0000005A (90)
Microsoft ACPI-Compliant System	(ISA) 0x0000005B (91)
Microsoft ACPI-Compliant System	(ISA) 0x0000005C (92)
Microsoft ACPI-Compliant System	(ISA) 0x0000005D (93)
Microsoft ACPI-Compliant System	(ISA) 0x0000005E (94)
Microsoft ACPI-Compliant System	(ISA) 0x0000005F (95)
Microsoft ACPI-Compliant System	(ISA) 0x00000060 (96)
Microsoft ACPI-Compliant System	(ISA) 0x00000061 (97)
Microsoft ACPI-Compliant System	(ISA) 0x00000062 (98)
Microsoft ACPI-Compliant System	(ISA) 0x00000063 (99)
Microsoft ACPI-Compliant System	(ISA) 0x00000064 (100)
Microsoft ACPI-Compliant System	(ISA) 0x00000065 (101)
Microsoft ACPI-Compliant System	(ISA) 0x00000066 (102)
Microsoft ACPI-Compliant System	(ISA) 0x00000067 (103)

---

 (ISA) 0x00000068 (104)	Microsoft ACPI-Compliant System
 (ISA) 0x00000069 (105)	Microsoft ACPI-Compliant System
 (ISA) 0x0000006A (106)	Microsoft ACPI-Compliant System
 (ISA) 0x0000006B (107)	Microsoft ACPI-Compliant System
 (ISA) 0x0000006C (108)	Microsoft ACPI-Compliant System
 (ISA) 0x0000006D (109)	Microsoft ACPI-Compliant System
 (ISA) 0x0000006E (110)	Microsoft ACPI-Compliant System
 (ISA) 0x0000006F (111)	Microsoft ACPI-Compliant System
 (ISA) 0x00000070 (112)	Microsoft ACPI-Compliant System
 (ISA) 0x00000071 (113)	Microsoft ACPI-Compliant System
 (ISA) 0x00000072 (114)	Microsoft ACPI-Compliant System
 (ISA) 0x00000073 (115)	Microsoft ACPI-Compliant System
 (ISA) 0x00000074 (116)	Microsoft ACPI-Compliant System
 (ISA) 0x00000075 (117)	Microsoft ACPI-Compliant System
 (ISA) 0x00000076 (118)	Microsoft ACPI-Compliant System
 (ISA) 0x00000077 (119)	Microsoft ACPI-Compliant System
 (ISA) 0x00000078 (120)	Microsoft ACPI-Compliant System
 (ISA) 0x00000079 (121)	Microsoft ACPI-Compliant System
 (ISA) 0x0000007A (122)	Microsoft ACPI-Compliant System
 (ISA) 0x0000007B (123)	Microsoft ACPI-Compliant System
 (ISA) 0x0000007C (124)	Microsoft ACPI-Compliant System
 (ISA) 0x0000007D (125)	Microsoft ACPI-Compliant System
 (ISA) 0x0000007E (126)	Microsoft ACPI-Compliant System
 (ISA) 0x0000007F (127)	Microsoft ACPI-Compliant System
 (ISA) 0x00000080 (128)	Microsoft ACPI-Compliant System
 (ISA) 0x00000081 (129)	Microsoft ACPI-Compliant System
 (ISA) 0x00000082 (130)	Microsoft ACPI-Compliant System
 (ISA) 0x00000083 (131)	Microsoft ACPI-Compliant System
 (ISA) 0x00000084 (132)	Microsoft ACPI-Compliant System
 (ISA) 0x00000085 (133)	Microsoft ACPI-Compliant System
 (ISA) 0x00000086 (134)	Microsoft ACPI-Compliant System
 (ISA) 0x00000087 (135)	Microsoft ACPI-Compliant System

	(ISA) 0x00000088 (136)	Microsoft ACPI-Compliant System
	(ISA) 0x00000089 (137)	Microsoft ACPI-Compliant System
	(ISA) 0x0000008A (138)	Microsoft ACPI-Compliant System
	(ISA) 0x0000008B (139)	Microsoft ACPI-Compliant System
	(ISA) 0x0000008C (140)	Microsoft ACPI-Compliant System
	(ISA) 0x0000008D (141)	Microsoft ACPI-Compliant System
	(ISA) 0x0000008E (142)	Microsoft ACPI-Compliant System
	(ISA) 0x0000008F (143)	Microsoft ACPI-Compliant System
	(ISA) 0x00000090 (144)	Microsoft ACPI-Compliant System
	(ISA) 0x00000091 (145)	Microsoft ACPI-Compliant System
	(ISA) 0x00000092 (146)	Microsoft ACPI-Compliant System
	(ISA) 0x00000093 (147)	Microsoft ACPI-Compliant System
	(ISA) 0x00000094 (148)	Microsoft ACPI-Compliant System
	(ISA) 0x00000095 (149)	Microsoft ACPI-Compliant System
	(ISA) 0x00000096 (150)	Microsoft ACPI-Compliant System
	(ISA) 0x00000097 (151)	Microsoft ACPI-Compliant System
	(ISA) 0x00000098 (152)	Microsoft ACPI-Compliant System
	(ISA) 0x00000099 (153)	Microsoft ACPI-Compliant System
	(ISA) 0x0000009A (154)	Microsoft ACPI-Compliant System
	(ISA) 0x0000009B (155)	Microsoft ACPI-Compliant System
	(ISA) 0x0000009C (156)	Microsoft ACPI-Compliant System
	(ISA) 0x0000009D (157)	Microsoft ACPI-Compliant System
	(ISA) 0x0000009E (158)	Microsoft ACPI-Compliant System
	(ISA) 0x0000009F (159)	Microsoft ACPI-Compliant System
	(ISA) 0x000000A0 (160)	Microsoft ACPI-Compliant System
	(ISA) 0x000000A1 (161)	Microsoft ACPI-Compliant System
	(ISA) 0x000000A2 (162)	Microsoft ACPI-Compliant System
	(ISA) 0x000000A3 (163)	Microsoft ACPI-Compliant System
	(ISA) 0x000000A4 (164)	Microsoft ACPI-Compliant System
	(ISA) 0x000000A5 (165)	Microsoft ACPI-Compliant System
	(ISA) 0x000000A6 (166)	Microsoft ACPI-Compliant System
	(ISA) 0x000000A7 (167)	Microsoft ACPI-Compliant System



(ISA) 0x000000A8 (168)	Microsoft ACPI-Compliant System
(ISA) 0x000000A9 (169)	Microsoft ACPI-Compliant System
(ISA) 0x000000AA (170)	Microsoft ACPI-Compliant System
(ISA) 0x000000AB (171)	Microsoft ACPI-Compliant System
(ISA) 0x000000AC (172)	Microsoft ACPI-Compliant System
(ISA) 0x000000AD (173)	Microsoft ACPI-Compliant System
(ISA) 0x000000AE (174)	Microsoft ACPI-Compliant System
(ISA) 0x000000AF (175)	Microsoft ACPI-Compliant System
(ISA) 0x000000B0 (176)	Microsoft ACPI-Compliant System
(ISA) 0x000000B1 (177)	Microsoft ACPI-Compliant System
(ISA) 0x000000B2 (178)	Microsoft ACPI-Compliant System
(ISA) 0x000000B3 (179)	Microsoft ACPI-Compliant System
(ISA) 0x000000B4 (180)	Microsoft ACPI-Compliant System
(ISA) 0x000000B5 (181)	Microsoft ACPI-Compliant System
(ISA) 0x000000B6 (182)	Microsoft ACPI-Compliant System
(ISA) 0x000000B7 (183)	Microsoft ACPI-Compliant System
(ISA) 0x000000B8 (184)	Microsoft ACPI-Compliant System
(ISA) 0x000000B9 (185)	Microsoft ACPI-Compliant System
(ISA) 0x000000BA (186)	Microsoft ACPI-Compliant System
(ISA) 0x000000BB (187)	Microsoft ACPI-Compliant System
(ISA) 0x000000BC (188)	Microsoft ACPI-Compliant System
(ISA) 0x000000BD (189)	Microsoft ACPI-Compliant System
(ISA) 0x000000BE (190)	Microsoft ACPI-Compliant System
(PCI) 0x00000005 (05)	Intel(R) Atom(TM)/Celeron(R)/Pentium(R) Processor Platform Control
(PCI) 0x0000000B (11)	Intel(R) Atom(TM)/Celeron(R)/Pentium(R) Processor Trusted Execution
(PCI) 0x00000010 (16)	Intel(R) Atom(TM)/Celeron(R)/Pentium(R) Processor PCI Express - Root
(PCI) 0x00000011 (17)	Intel(R) Atom(TM)/Celeron(R)/Pentium(R) Processor PCI Express - Root
(PCI) 0x00000012 (18)	Intel(R) Atom(TM)/Celeron(R)/Pentium(R) Processor PCI Express - Root
(PCI) 0x00000012 (18)	SDA Standard Compliant SD Host Controller
(PCI) 0x00000013 (19)	Intel(R) Atom(TM)/Celeron(R)/Pentium(R) Processor AHCI - 0F23
(PCI) 0x00000013 (19)	Intel(R) Atom(TM)/Celeron(R)/Pentium(R) Processor PCI Express - Root
(PCI) 0x00000016 (22)	High Definition Audio Controller
(PCI) 0xFFFFFFFF1 (-15)	Intel(R) I210 Gigabit Network Connection #2
(PCI) 0xFFFFFFFF2 (-14)	Intel(R) I210 Gigabit Network Connection #2
(PCI) 0xFFFFFFFF3 (-13)	Intel(R) I210 Gigabit Network Connection #2
(PCI) 0xFFFFFFFF4 (-12)	Intel(R) I210 Gigabit Network Connection #2
(PCI) 0xFFFFFFFF5 (-11)	Intel(R) I210 Gigabit Network Connection #2
(PCI) 0xFFFFFFFF6 (-10)	Intel(R) I210 Gigabit Network Connection #2
(PCI) 0xFFFFFFFF7 (-9)	Intel(R) I210 Gigabit Network Connection
(PCI) 0xFFFFFFFF8 (-8)	Intel(R) I210 Gigabit Network Connection
(PCI) 0xFFFFFFFF9 (-7)	Intel(R) I210 Gigabit Network Connection
(PCI) 0xFFFFFFFFA (-6)	Intel(R) I210 Gigabit Network Connection
(PCI) 0xFFFFFFFFB (-5)	Intel(R) I210 Gigabit Network Connection
(PCI) 0xFFFFFFFFC (-4)	Intel(R) I210 Gigabit Network Connection
(PCI) 0xFFFFFFFFD (-3)	Intel(R) USB 3.0 eXtensible Host Controller
(PCI) 0xFFFFFFFFE (-2)	Intel(R) Atom(TM) Processor E3800 Series/Intel(R) Celeron(R) Processor

▶ Memory

# Appendix C

---

Mating Connectors

## C.1 List of Mating Connectors and Cables

Connector Label	Function	Mating Connector		Available Cable	Cable P/N
		Vendor	Model no		
CN1	Amplifier right channel output	Molex	51021-0200	N/A	N/A
CN2	Amplifier left channel output	Molex	51021-0200	N/A	N/A
CN3	External +5VSB Power output and PS_ON#	Catch Electronics	2418HJ-06	N/A	N/A
CN4	Digital I/O Connector	Neltron	2026B-10	N/A	N/A
CN5	External +5VSB Power Input and PS_ON#	JST	PHR-3	ATX Cable	170220020B
CN6	+5Vout Connector	JST	PHR-2	2 Pins For HDD Power	1702150155
CN8	+9~24V Vin Connector	N/A	N/A	Power Cable	1702002010
CN9	Audio Connector	Molex	51021-1000	Audio Cable	1709100254
CN10	COM Port 4 Connector	Molex	51021-0900	Serial Port Cable	1701090150
CN12	COM Port 3 Connector	Molex	51021-0900	Serial Port Cable	1701090150
CN15	COM Port 2 Connector	Molex	51021-0900	Serial Port Cable	1701090150
CN18	USB Port Connector	Molex	51021-0500	USB Wafer Cable	1700050207
CN19	USB Port Connector	Molex	51021-0500	USB Wafer Cable	1700050207

CN20	COM Port 1 Connector	Molex	51021-0900	Serial Port Cable	1701090150
CN21	LVDS Connector	HIROSE	DF13-30DS-1.25C	N/A	N/A
CN22	P/S2 KB/MS Connector	JST	PHDR-06VS	P/S2 KB/MS Cable	1700060157
CN23	Touch Screen Connector	JST	SHR-9V-S-B	N/A	N/A
CN24	LVDS Inverter Connector	JST	PHR-5	N/A	N/A
CN25	CPU Fan Connector	Molex	22-01-2035	N/A	N/A

# Appendix D

---

Electrical Specifications for I/O Ports

## D.1 Electrical Specifications for I/O Ports

I/O	Reference	Signal name	Rate output
Digital IO Port	CN4	+5V	+5V/1A
+5V Output for SATA HDD	CN6	+5V	+5V/1A
Audio I/O Port	CN9	+5V	+5V/1A
LPC Port	CN11	+3.3V	+3.3V/0.5A
COM Port 3	CN12	+5V/+12V	+5V/1A or +12V/1A
MiniCard Slot (Half-MiniCard)	CN14	+3.3VSB +1.5V	+3.3V/1.1A +1.5V/0.375A
COM Port 2	CN15	+5V/+12V	+5V/1A or +12V/1A
Mini-Card Slot (Full-MiniCard)	CN17	+3.3VSB +1.5V	+3.3V/1.1A +1.5V/0.375A
USB 2.0 Ports 3	CN18	+5VSB	+5V/0.5A (per channel)
USB 2.0 Ports 2	CN19	+5VSB	
LVDS Port	CN21	+3.3V/+5V	+3.3V/2A or +5V/2A

PS/2 Keyboard/Mouse Combo Port	CN22	+5VSB	+5V/1A
LVDS Port Inverter / Backlight Connector	CN24	+5V/+12V	+5V/1.5A or +12V/1.5A
CPU FAN	CN25	+12V	+12V/0.5A
USB Ports 0 and 1	CN28	+5VSB	+5V/1A (per channel)
DP port	CN29	+3.3V	+3.3V/1A
HDMI Port	CN31	+5V	+5V/1A
VGA Port	CN33	+5V	+5V/1A (reserved)

# Appendix E

---

Digital I/O Ports



## E.1 Digital I/O Register

7.1.2 Logic Device Number Register (LDN) — Index 07h

Bit	Name	R/W	Reset	Default	Description
7-0	LDN	R/W	LRESET#	00h	00h: Select FDC device configuration registers. 03h: Select Parallel Port device configuration registers. 04h: Select Hardware Monitor device configuration registers. 05h: Select KBC device configuration registers. 06h: Select GPIO device configuration registers. 07h: Select WDT device configuration registers. 0Ah: Select PME, ACPI and ERP device configuration registers. 10h: Select UART1 device configuration registers. 11h: Select UART2 device configuration registers. 12h: Select UART3 device configuration registers. 13h: Select UART4 device configuration registers. 14h: Select UART5 device configuration registers. 15h: Select UART6 device configuration registers. Otherwise: Reserved.

GPIO5 Output Enable Register — Index A0h

Bit	Name	R/W	Reset	Default	Description
7	GPIO57_OE	R/W	LRESET#	0	0: GPIO57 is in input mode. 1: GPIO57 is in output mode.
6	GPIO56_OE	R/W	LRESET#	0	0: GPIO56 is in input mode. 1: GPIO56 is in output mode.
5	GPIO55_OE	R/W	LRESET#	0	0: GPIO55 is in input mode. 1: GPIO55 is in output mode.
4	GPIO54_OE	R/W	LRESET#	0	0: GPIO54 is in input mode. 1: GPIO54 is in output mode.
3	GPIO53_OE	R/W	LRESET#	0	0: GPIO53 is in input mode. 1: GPIO53 is in output mode.
2	GPIO52_OE	R/W	LRESET#	0	0: GPIO52 is in input mode. 1: GPIO52 is in output mode.
1	GPIO51_OE	R/W	LRESET#	0	0: GPIO51 is in input mode. 1: GPIO51 is in output mode.
0	GPIO50_OE	R/W	LRESET#	0	0: GPIO50 is in input mode. 1: GPIO50 is in output mode.

**GPIO5 Output Data Register — Index A1h (This byte could be also written by base address + 5)**

Bit	Name	R/W	Reset	Default	Description
7	GPIO57_DATA	R/W	LRESET#	1	0: GPIO57 outputs 0 when in output mode. 1: GPIO57 outputs 1 when in output mode.
6	GPIO56_DATA	R/W	LRESET#	1	0: GPIO56 outputs 0 when in output mode. 1: GPIO56 outputs 1 when in output mode.
5	GPIO55_DATA	R/W	LRESET#	1	0: GPIO55 outputs 0 when in output mode. 1: GPIO55 outputs 1 when in output mode.
4	GPIO54_DATA	R/W	LRESET#	1	0: GPIO54 outputs 0 when in output mode. 1: GPIO54 outputs 1 when in output mode.
3	GPIO53_DATA	R/W	LRESET#	1	0: GPIO53 outputs 0 when in output mode. 1: GPIO53 outputs 1 when in output mode.
2	GPIO52_DATA	R/W	LRESET#	1	0: GPIO52 outputs 0 when in output mode. 1: GPIO52 outputs 1 when in output mode.
1	GPIO51_DATA	R/W	LRESET#	1	0: GPIO51 outputs 0 when in output mode. 1: GPIO51 outputs 1 when in output mode.
0	GPIO50_DATA	R/W	LRESET#	1	0: GPIO50 outputs 0 when in output mode. 1: GPIO50 outputs 1 when in output mode.

**GPIO5 Pin Status Register — Index A2h (This byte could be also read by base address + 5)**

Bit	Name	R/W	Reset	Default	Description
7	GPIO57_ST	R	-	-	The pin status of GPIO57/WGATE#/DSR6#.
6	GPIO56_ST	R	-	-	The pin status of GPIO56/HDSEL#/DTR6#.
5	GPIO55_ST	R	-	-	The pin status of GPIO55/STEP#/CTS6#.

4	GPIO54_ST	R	-	-	The pin status of GPIO54/DIR#/RI6#.
3	GPIO53_ST	R	-	-	The pin status of GPIO53/WDATA#/DCD6#.
2	GPIO52_ST	R	-	-	The pin status of GPIO52/DRVA#/SOUT6.
1	GPIO51_ST	R	-	-	The pin status of GPIO51/MOA#/SIN6.
0	GPIO50_ST	R	-	-	The pin status of GPIO50/DENSEL#/RTS6#.

## E.2 Digital I/O Sample Code (4 in 4 out, 2 low 2 high)

---

```
Outputb(0x2E,0x87); //enter configuration
```

```
Outputb(0x2E,0x87);
```

```
Outputb(0x2E,0x07); //set LDN
```

```
Outputb(0x2F,0x06);
```

```
Outputb(0x2E,0xA0); //GPIO set 5 register
```

```
Outputb(0x2F,0xF0);
```

```
Outputb(0x2E,0xA1); //GPIO output data register
```

```
Outputb(0x2F,0x30);
```

```
Outputb(0x2E,0xAA); //exit configuration
```