

# GENE-APL5

---

3.5" Subcompact Board

User's Manual 3<sup>rd</sup> Ed

## Copyright Notice

---

This document is copyrighted, 2018. All rights are reserved. The original manufacturer reserves the right to make improvements to the products described in this manual at any time without notice.

No part of this manual may be reproduced, copied, translated, or transmitted in any form or by any means without the prior written permission of the original manufacturer. Information provided in this manual is intended to be accurate and reliable. However, the original manufacturer assumes no responsibility for its use, or for any infringements upon the rights of third parties that may result from its use.

The material in this document is for product information only and is subject to change without notice. While reasonable efforts have been made in the preparation of this document to assure its accuracy, AAEMON assumes no liabilities resulting from errors or omissions in this document, or from the use of the information contained herein.

AAEMON reserves the right to make changes in the product design without notice to its users.

## Acknowledgement

---

All other products' name or trademarks are properties of their respective owners.

- Microsoft Windows is a registered trademark of Microsoft Corp.
- Intel, Pentium, Celeron, and Xeon are registered trademarks of Intel Corporation
- Core, Atom are trademarks of Intel Corporation
- ITE is a trademark of Integrated Technology Express, Inc.
- IBM, PC/AT, PS/2, and VGA are trademarks of International Business Machines Corporation.

All other product names or trademarks are properties of their respective owners.

## Packing List

---

Before setting up your product, please make sure the following items have been shipped:

Item	Quantity
● GENE-APL5	1
● Product DVD with User's Manual (in pdf) and drivers	1

If any of these items are missing or damaged, please contact your distributor or sales representative immediately.

## About this Document

---

This User's Manual contains all the essential information, such as detailed descriptions and explanations on the product's hardware and software features (if any), its specifications, dimensions, jumper/connector settings/definitions, and driver installation instructions (if any), to facilitate users in setting up their product.

Users may refer to the [AAEON.com](http://AAEON.com) for the latest version of this document.

## Safety Precautions

---

Please read the following safety instructions carefully. It is advised that you keep this manual for future references

1. All cautions and warnings on the device should be noted.
2. Make sure the power source matches the power rating of the device.
3. Position the power cord so that people cannot step on it. Do not place anything over the power cord.
4. Always completely disconnect the power before working on the system's hardware.
5. No connections should be made when the system is powered as a sudden rush of power may damage sensitive electronic components.
6. If the device is not to be used for a long time, disconnect it from the power supply to avoid damage by transient over-voltage.
7. Always disconnect this device from any AC supply before cleaning.
8. While cleaning, use a damp cloth instead of liquid or spray detergents.
9. Make sure the device is installed near a power outlet and is easily accessible.
10. Keep this device away from humidity.
11. Place the device on a solid surface during installation to prevent falls
12. Do not cover the openings on the device to ensure optimal heat dissipation.
13. Watch out for high temperatures when the system is running.
14. Do not touch the heat sink or heat spreader when the system is running
15. Never pour any liquid into the openings. This could cause fire or electric shock.
16. As most electronic components are sensitive to static electrical charge, be sure to ground yourself to prevent static charge when installing the internal components. Use a grounding wrist strap and contain all electronic components in any static-shielded containers.

17. If any of the following situations arises, please the contact our service personnel:
  - i. Damaged power cord or plug
  - ii. Liquid intrusion to the device
  - iii. Exposure to moisture
  - iv. Device is not working as expected or in a manner as described in this manual
  - v. The device is dropped or damaged
  - vi. Any obvious signs of damage displayed on the device
18. **DO NOT LEAVE THIS DEVICE IN AN UNCONTROLLED ENVIRONMENT WITH TEMPERATURES BEYOND THE DEVICE'S PERMITTED STORAGE TEMPERATURES (SEE CHAPTER 1) TO PREVENT DAMAGE.**

### **Warning!**



This device complies with Part 15 FCC Rules. Operation is subject to the following two conditions: (1) this device may not cause harmful interference, and (2) this device must accept any interference received including interference that may cause undesired operation.

### **Caution:**

*There is a danger of explosion if the battery is incorrectly replaced. Replace only with the same or equivalent type recommended by the manufacturer. Dispose of used batteries according to the manufacturer's instructions and your local government's recycling or disposal directives.*

### **Attention:**

*Il y a un risque d'explosion si la batterie est remplacée de façon incorrecte. Ne la remplacer qu'avec le même modèle ou équivalent recommandé par le constructeur. Recycler les batteries usées en accord avec les instructions du fabricant et les directives gouvernementales de recyclage.*



## China RoHS Requirements (CN)

产品中有毒有害物质或元素名称及含量

AAEON Main Board/ Daughter Board/ Backplane

部件名称	有毒有害物质或元素					
	铅 (Pb)	汞 (Hg)	镉 (Cd)	六价铬 (Cr(VI))	多溴联苯 (PBB)	多溴二苯醚 (PBDE)
印刷电路板 及其电子组件	○	○	○	○	○	○
外部信号 连接器及线材	○	○	○	○	○	○
<p>O: 表示该有毒有害物质在该部件所有均质材料中的含量均在 SJ/T 11363-2006 标准规定的限量要求以下。</p> <p>X: 表示该有毒有害物质至少在该部件的某一均质材料中的含量超出 SJ/T 11363-2006 标准规定的限量要求。</p> <p>备注: 此产品所标示之环保使用期限, 系指在一般正常使用状况下。</p>						

## China RoHS Requirement (EN)

Poisonous or Hazardous Substances or Elements in Products

AAEON Main Board/ Daughter Board/ Backplane

Component	Poisonous or Hazardous Substances or Elements					
	Lead (Pb)	Mercury (Hg)	Cadmium (Cd)	Hexavalent Chromium (Cr(VI))	Polybrominated Biphenyls (PBB)	Polybrominated Diphenyl Ethers (PBDE)
PCB & Other Components	○	○	○	○	○	○
Wires & Connectors for External Connections	○	○	○	○	○	○
<p>O: The quantity of poisonous or hazardous substances or elements found in each of the component's parts is below the SJ/T 11363-2006-stipulated requirement.</p> <p>X: The quantity of poisonous or hazardous substances or elements found in at least one of the component's parts is beyond the SJ/T 11363-2006-stipulated requirement.</p> <p><b>Note:</b> The Environment Friendly Use Period as labeled on this product is applicable under normal usage only</p>						

# Table of Contents

---

<b>Chapter 1 - Product Specifications</b> .....	<b>1</b>
1.1 Specifications .....	2
<b>Chapter 2 – Hardware Information</b> .....	<b>5</b>
2.1 Dimensions .....	6
2.1.1 Dimensions (Optional HDMI SKU) .....	8
2.2 Jumpers and Connectors.....	10
2.2.1 Jumpers and Connectors (Optional HDMI SKU).....	12
2.3 Block Diagram .....	14
2.4 List of Jumpers .....	15
2.4.1 LVDS Port 1 Backlight Inverter VCC Selection (JP1) .....	16
2.4.2 LVDS Port 1 Operating VDD Selection (JP1) .....	16
2.4.3 LVDS Port 1 Backlight Lightness Control Mode Selection (JP2) ..	16
2.4.4 COM2 Pin8 Function Selection (JP3).....	16
2.4.5 COM3 Pin8 Function Selection (JP4).....	17
2.4.6 Auto Power Button Enable/Disable Selection (JP5) .....	17
2.4.7 Front Panel Connector (JP6) .....	17
2.4.8 LVDS Port 2 Backlight Inverter VCC Selection (JP7) .....	18
2.4.9 LVDS Port 2 Operating VDD Selection (JP7) .....	18
2.4.10 LVDS Port 2 Backlight Lightness Control Mode Selection (JP8) .	18
2.4.11 Touch Screen 4, 5, 8 Wire Selection (JP9) .....	18
2.4.12 Clear CMOS Jumper (JP10).....	19
2.5 List of Connectors.....	20
2.5.1 +5VSB Output w/SMBus (CN1) .....	22
2.5.2 LVDS Port 1 Inverter / Backlight Connector (CN2) .....	22
2.5.3 +5V Output for SATA HDD (CN3).....	23
2.5.4 SATA Port (CN4).....	23

2.5.5	External Power Input (CN5).....	24
2.5.6	External +5VSB Input (CN6) (Optional).....	24
2.5.7	Audio I/O Port (CN7).....	25
2.5.8	LVDS Port 1 (CN8).....	26
2.5.9	COM Port 2 (CN9).....	28
2.5.10	LPT Port or Digital I/O Port (CN10).....	30
2.5.11	LPC Port (CN11).....	33
2.5.12	COM Port 3 (CN12).....	34
2.5.13	BIOS Debug Port (CN13).....	36
2.5.14	COM Port 4 (CN14).....	36
2.5.15	PS/2 Keyboard/Mouse Combo Port (CN15).....	37
2.5.16	USB 2.0 Port 2 (CN16).....	38
2.5.17	USB 2.0 Port 3 (CN17).....	38
2.5.18	COM Port 1 (CN18) (Wafer, Optional).....	39
2.5.19	USB 2.0 Port 4 (CN19).....	40
2.5.20	USB 2.0 Port 5 (CN20).....	40
2.5.21	LVDS Port 2 (CN21).....	41
2.5.22	Touchscreen Connector (CN22).....	43
2.5.23	CPU Fan (CN23, Optional).....	46
2.5.24	LVDS Port 2 Inverter / Backlight Connector (CN24).....	46
2.5.25	USB 3.0 Ports 0 and 1 (CN25).....	47
2.5.26	LAN (RJ-45) Port 2 (CN26).....	48
2.5.27	LAN (RJ-45) Port 1 (CN27).....	48
2.5.28	COM Port 1 (CN28, D-SUB 9).....	49
2.5.29	HDMI Port (CN29, Optional).....	50
2.5.30	Battery (CN30).....	51
2.5.31	VGA Port (CN31).....	51
2.5.32	Micro SIM Card Socket (CN32).....	52

2.5.33	Mini-Card Slot (Half-Mini) (CN33) .....	52
2.5.34	mSATA (Full-Size) (CN34).....	55
<b>Chapter 3 - AMI BIOS Setup .....</b>		<b>58</b>
3.1	System Test and Initialization .....	59
3.2	AMI BIOS Setup .....	60
3.3	Setup submenu: Main .....	61
3.4	Setup submenu: Advanced .....	62
3.4.1	Advanced: Trusted Computing.....	63
3.4.2	Advanced: CPU Configuration .....	65
3.4.3	Advanced: SATA Configuration .....	67
3.4.3.1	PCI Express Configuration.....	69
3.4.4	Advanced: Hardware Monitor .....	70
3.4.4.1	CPU Smart Fan Configuration .....	71
3.4.5	Advanced: SIO Configuration.....	72
3.4.5.1	SIO Configuration: Serial Port 1 Configuration .....	73
3.4.5.2	SIO Configuration: Serial Port 2 Configuration.....	74
3.4.5.3	SIO Configuration: Serial Port 3 Configuration.....	75
3.4.5.4	SIO Configuration: Serial Port 4 Configuration.....	76
3.4.5.5	SIO Configuration: Parallel Port Configuration .....	77
3.4.6	Advanced: Power Management.....	78
3.4.7	Advanced: Digital IO Port Configuration .....	79
3.5	Setup submenu: Chipset.....	80
3.5.1	Chipset: North Bridge .....	81
3.5.1.1	North Bridge: LVDS Panel Configuration .....	82
3.6	Setup submenu: Security .....	84
3.7	Setup submenu: Boot.....	85
3.8	Setup submenu: Save & Exit .....	86
3.9	Note for Users.....	87

<b>Chapter 4 – Drivers Installation</b> .....	<b>88</b>
4.1 Product CD/DVD .....	89
<b>Appendix A - Watchdog Timer Programming</b> .....	<b>91</b>
A.1 Watchdog Timer Registers .....	92
A.2 Watchdog Sample Program.....	93
<b>Appendix B - I/O Information</b> .....	<b>96</b>
B.1 I/O Address Map .....	97
B.2 Memory Address Map .....	99
B.3 IRQ Mapping Chart.....	100
<b>Appendix C – Mating Connectors</b> .....	<b>105</b>
C.1 List of Mating Connectors and Cables.....	106
<b>Appendix D – Electrical Specifications for I/O Ports</b> .....	<b>109</b>
D.1 Electrical Specifications for I/O Ports.....	110
<b>Appendix E – Digital I/O Ports</b> .....	<b>111</b>
E.1 Digital I/O Register.....	112
E.2 Digital I/O Sample Code (4 in 4 out, 2 low 2 high).....	114

# Chapter 1

---

Product Specifications

## 1.1 Specifications

---

### System

● Form Factor	3.5"
● CPU	Intel® Pentium® N4200 / Celeron® N3350 Processor SoC
● CPU Frequency	Up to 2.5 GHz
● Chipset	Intel® Atom™ N4200/ N3350 Processor SoC
● Memory Type	DDR3L 1866MHz SODIMM x 1
● Max Memory Capacity	Up to 8 GB
● BIOS	UEFI
● Wake On LAN	Yes
● Watchdog Timer	255 levels
● Power Requirement	+12 V or 9 ~ 19 V (optional)
● Power Supply Type	AT/ATX
● Power Consumption (Typical)	Intel® N4200, DDR3L 1600MHz 8G, 0.8A@ +12V
● Dimensions (L x W)	146 x 101.7 mm (5.75 x 4")
● Operating Temperature	0 ~ 60°C (32 ~ 140°F)
● Storage Temperature	-40 ~ 81°C (-40 ~ 176°F)
● Operation Humidity	10 ~ 90% relative humidity, non-condensing
● MTBF	-



- Certification CE/FCC

## Display

- **VGA/LCD Controller** Intel® Pentium® N4200 / Celeron® N3350 Processor SoC integrated
- **Video Output** VGA/LVDS/ LVDS2 (co-layout with HDMI, optional)
- **Backlight Inverter Supply** Yes

## I/O

- **Ethernet** Intel® I210/I211, 10/100/1000Base-TX, RJ-45 x 2
- **Audio** High definition audio interface
- **USB** USB 3.0 x 2  
USB 2.0 x 4
- **Serial Port** RS-232 x 2  
RS-232/422/485 x 2
- **Parallel Port** SPP/EPP/ECP x 1 (option, share with DIO)
- **HDD Interface** SATA 3.0 x 1  
+5V SATA power connector x 1
- **SSD** mSATA
- **Expansion Slot** Mini Card x 2 and default is  
1.1. mSATA x 1 (full-size)  
1.2. miniCard x 1(half-size)
- **DI/O** 8-bit
- **SIM** 1 (uSIM, option)

- TPM 1 (option)
- Touch 1 (option)

# Chapter 2

---

Hardware Information

## 2.1 Dimensions

### Component Side

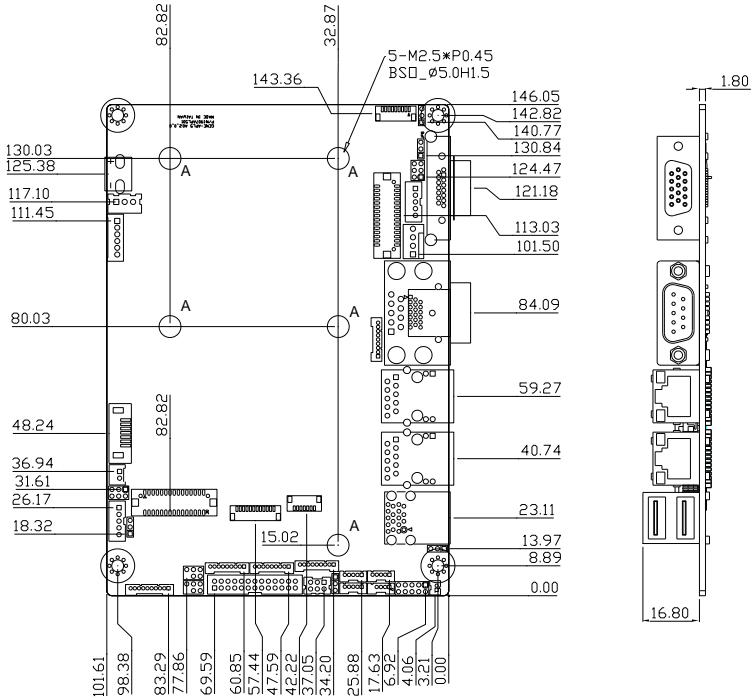

# Solder Side

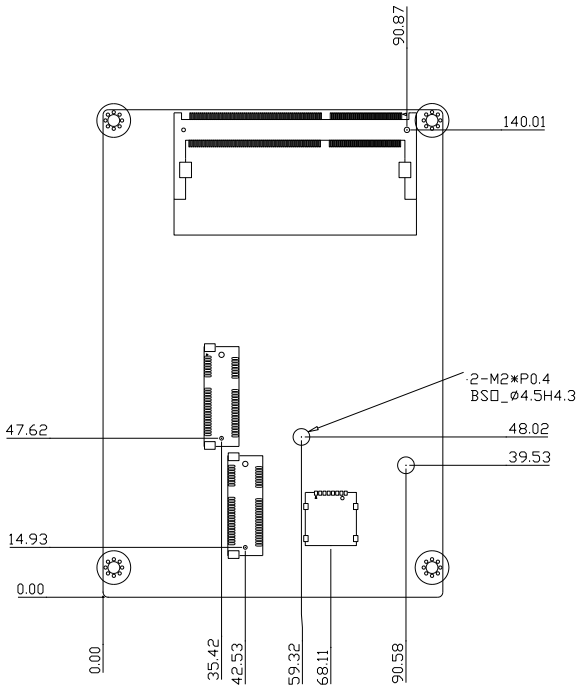

## 2.1.1 Dimensions (Optional HDMI SKU)

### Component Side

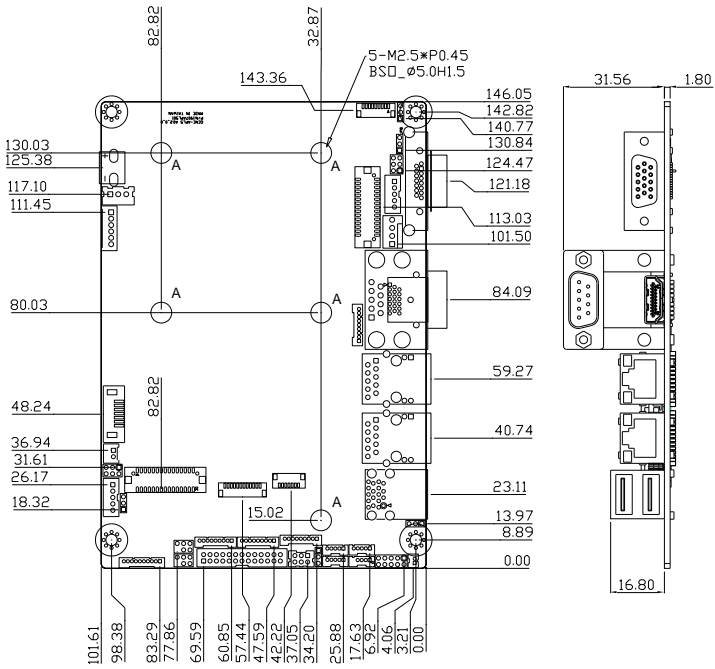

### Solder Side

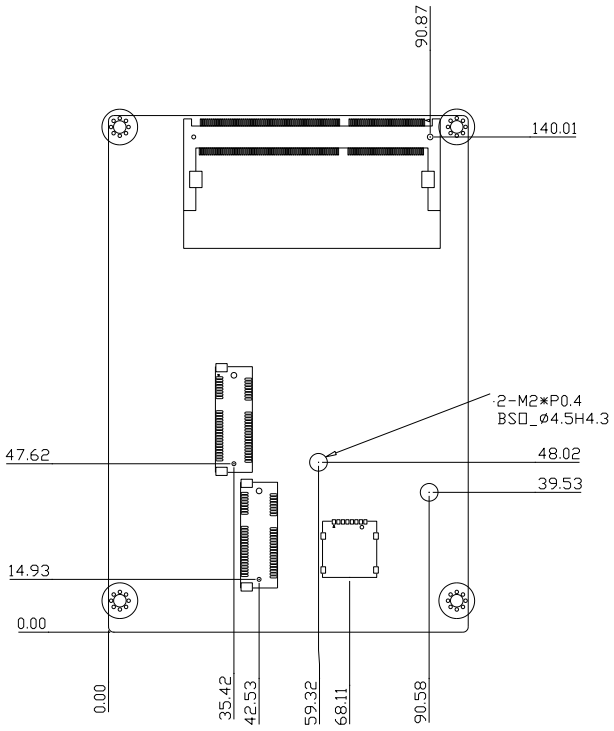

## 2.2 Jumpers and Connectors

### Component Side

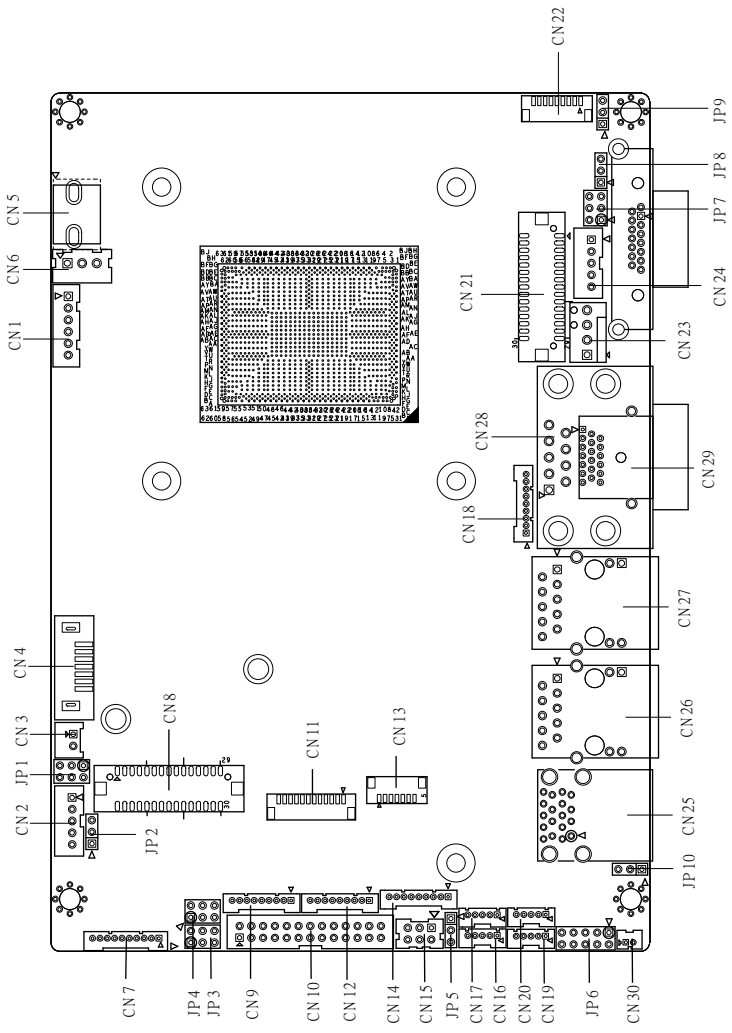



### Solder Side

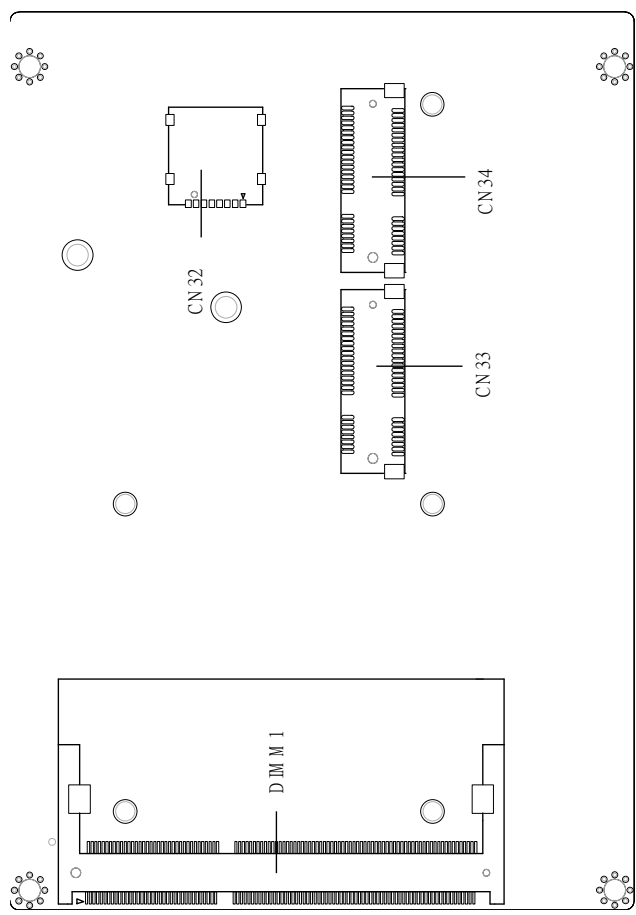

## 2.2.1 Jumpers and Connectors (Optional HDMI SKU)

### Component Side

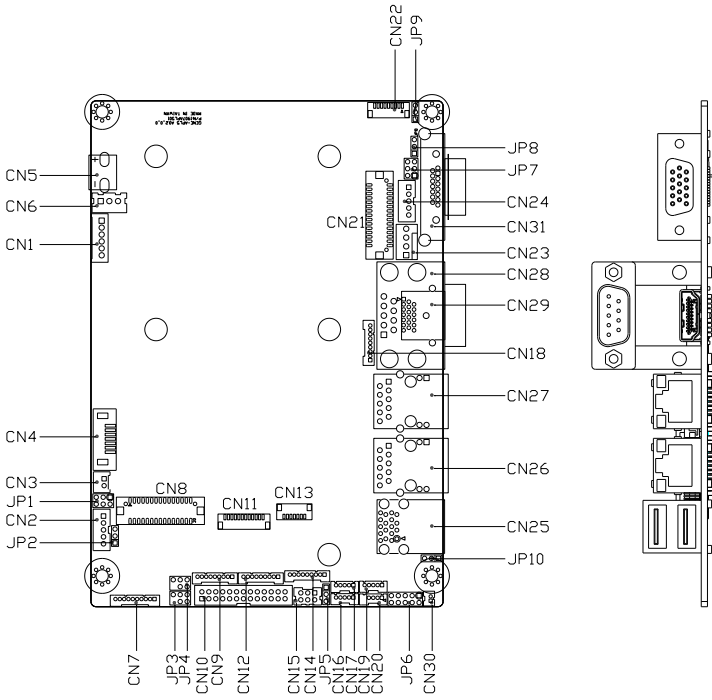

### Solder Side

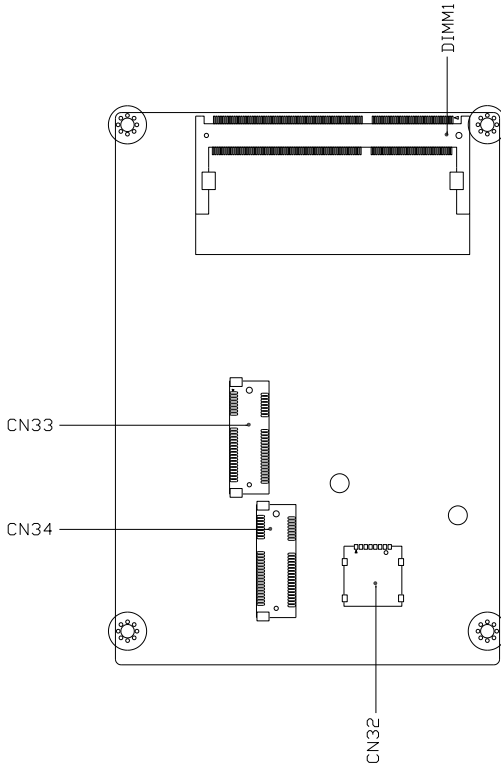

## 2.3 Block Diagram

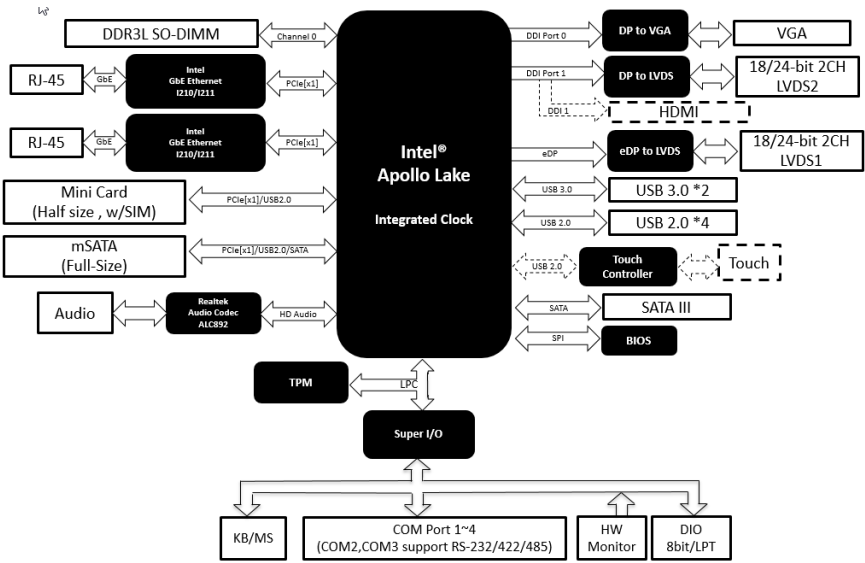

## 2.4 List of Jumpers

---

Please refer to the table below for all of the board's jumpers that you can configure for your application

Label	Function
JP1	LVDS Port1 Backlight Inverter VCC Selection and Operating VDD Selection
JP2	LVDS Port1 Backlight Lightness Control Mode Selection
JP3	COM2 Pin8 Function Selection
JP4	COM3 Pin8 Function Selection
JP5	Auto Power Button Enable/Disable Selection
JP6	Front Panel Connector
JP7	LVDS Port2 Backlight Inverter VCC Selection and Operating VDD Selection
JP8	LVDS Port2 Backlight Lightness Control Mode Selection
JP9	Touch Screen 4/5/8-wire Mode Selection
JP10	Clear CMOS Jumper

### 2.4.1 LVDS Port 1 Backlight Inverter VCC Selection (JP1)

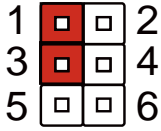

+12V

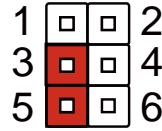

+5V (Default)

### 2.4.2 LVDS Port 1 Operating VDD Selection (JP1)

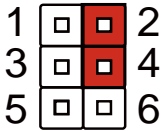

+3.3V (Default)

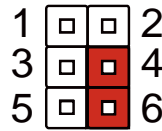

+5V

### 2.4.3 LVDS Port 1 Backlight Lightness Control Mode Selection (JP2)

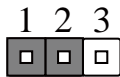

VR Mode (Default)



PWM Mode

### 2.4.4 COM2 Pin8 Function Selection (JP3)

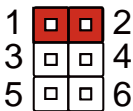

+12V

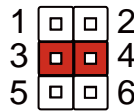

Ring (Default)

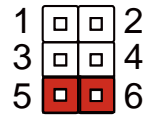

+5V

## 2.4.5 COM3 Pin8 Function Selection (JP4)

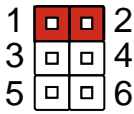

+12V

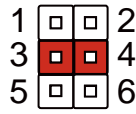

Ring (Default)

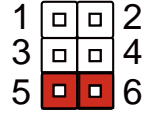

+5V

## 2.4.6 Auto Power Button Enable/Disable Selection (JP5)

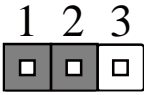

Disable/ATX



Enable/AT (Default)

※ When disabled, the power button of JP6 (1-2) will be used to power on the system.

## 2.4.7 Front Panel Connector (JP6)

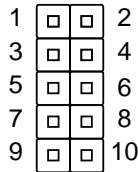

Pin	Pin Name	Pin	Pin Name
1	PWR_BTN-	2	PWR_BTN+
3	HDD_LED-	4	HDD_LED+
5	SPEAKER-	6	SPEAKER+
7	PWR_LED-	8	PWR_LED+
9	H/W RESET-	10	H/W RESET+

## 2.4.8 LVDS Port 2 Backlight Inverter VCC Selection (JP7)

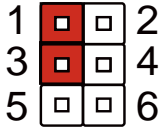

+12V

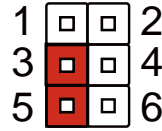

+5V (Default)

## 2.4.9 LVDS Port 2 Operating VDD Selection (JP7)

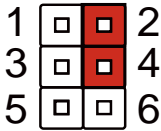

+3.3V (Default)

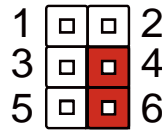

+5V

## 2.4.10 LVDS Port 2 Backlight Lightness Control Mode Selection (JP8)

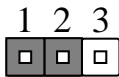

VR Mode (Default)



PWM Mode

## 2.4.11 Touch Screen 4, 5, 8 Wire Selection (JP9)

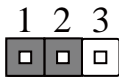

4/8 Wires Mode (Default)



5 Wires Mode



## 2.4.12 Clear CMOS Jumper (JP10)

---

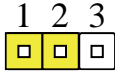

Normal (Default)

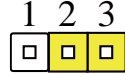

Clear CMOS

## 2.5 List of Connectors

Please refer to the table below for all of the board's connectors that you can configure for your application

Label	Function
CN1	+5VSB Output w/SMBus
CN2	LVDS Port1 Inverter / Backlight Connector
CN3	+5V Output for SATA HDD
CN4	SATA Port
CN5	External Power Input
CN6	External +5VSB Input (Optional)
CN7	Audio I/O Port
CN8	LVDS Port1
CN9	COM Port 2
CN10	LPT Port or Digital I/O Port
CN11	LPC Port
CN12	COM Port 3
CN13	SPI Debug Port
CN14	COM Port 4
CN15	PS/2 Keyboard/Mouse Combo Port
CN16	USB 2.0 Port 2
CN17	USB 2.0 Port 3
CN18	COM Port 1 (Wafer, Optional)
CN19	USB 2.0 Port 4
CN20	USB 2.0 Port 5
CN21	LVDS Port2
CN22	Touch Screen Connector (Optional)
CN23	CPU FAN (Optional)

Label	Function
CN24	LVDS Port2 Inverter / Backlight Connector
CN25	USB Ports 0 and 1
CN26	LAN (RJ-45) Port2
CN27	LAN (RJ-45) Port1
CN28	COM Port 1 (D-SUB 9)
CN29	HDMI Port (Optional)
CN30	Battery
CN31	VGA Port
CN32	Micro SIM Card Socket
CN33	Mini-Card Slot (Half-Size)
CN34	mSATA Slot (Full-Size)
DIMM1	DDR3L SO-DIMM Slot

## 2.5.1 +5VSB Output w/SMBus (CN1)

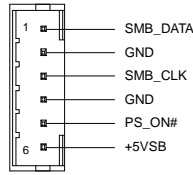

Pin	Pin Name	Signal Type	Signal level
1	SMB_DATA	I/O	+3.3V
2	GND	GND	
3	SMB_CLK	I/O	+3.3V
4	GND	GND	
5	PS_ON#	OUT	+5V
6	+5VSB	PWR	+5V

## 2.5.2 LVDS Port 1 Inverter / Backlight Connector (CN2)

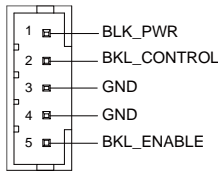

Pin	Pin Name	Signal Type	Signal level
1	BKL_PWR	PWR	+5V / +12V
2	BKL_CONTROL	OUT	
3	GND	GND	
4	GND	GND	
5	BKL_ENABLE	OUT	+5V

\* LVDS BKL\_PWR can be set to +5V or +12V by JP1

\* LVDS BKL\_CONTROL can be set by JP2

### 2.5.3 +5V Output for SATA HDD (CN3)

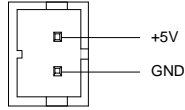

Pin	Pin Name	Signal Type	Signal Level
1	+5V	PWR	+5V
2	GND	GND	

### 2.5.4 SATA Port (CN4)

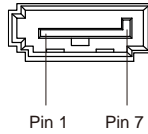

Pin	Pin Name	Signal Type	Signal Level
1	GND	GND	
2	SATA_TX+	DIFF	
3	SATA_TX-	DIFF	
4	GND	GND	
5	SATA_RX-	DIFF	
6	SATA_RX+	DIFF	
7	GND	GND	

## 2.5.5 External Power Input (CN5)

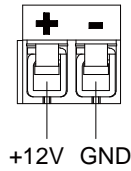

Pin	Pin Name	Signal Type	Signal Level
1	+VIN	PWR	9V~19V or 12V
2	GND	GND	

※There are two types of power input, 9V~19V or 12V only, by BOM Change.

## 2.5.6 External +5VSB Input (CN6) (Optional)

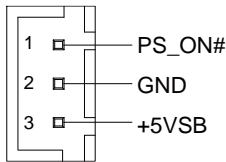

Pin	Pin Name	Signal Type	Signal Level
1	PS_ON#	OUT	+5V
2	GND	GND	
3	+5VSB	PWR	+5V

※Please make sure ATX power is full discharge when a system that use this connector(CN6) power off. Discharge time is relative to power supply and it may be 3~5s or more seconds.

## 2.5.7 Audio I/O Port (CN7)

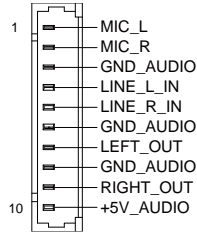

Pin	Pin Name	Signal Type	Signal Level
1	MIC_L	IN	
2	MIC_R	IN	
3	GND_AUDIO	GND	
4	LINE_L_IN	IN	
5	LINE_R_IN	IN	
6	GND_AUDIO	GND	
7	LEFT_OUT	OUT	
8	GND_AUDIO	GND	
9	RIGHT_OUT	OUT	
10	+5V_AUDIO	PWR	+5V

## 2.5.8 LVDS Port 1 (CN8)

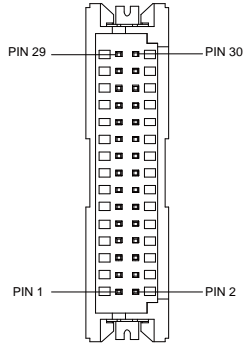

\*LVDS LCD\_PWR can be set to +3.3V or +5V by JP1

Pin	Pin Name	Signal Type	Signal Level
1	BKL_ENABLE	OUT	
2	BKL_CONTROL	OUT	
3	LCD_PWR	PWR	+3.3V/+5V
4	GND	GND	
5	LVDS_A_CLK-	DIFF	
6	LVDS_A_CLK+	DIFF	
7	LCD_PWR	PWR	+3.3V/+5V
8	GND	GND	
9	LVDS_DA0-	DIFF	
10	LVDS_DA0+	DIFF	
11	LVDS_DA1-	DIFF	
12	LVDS_DA1+	DIFF	
13	LVDS_DA2-	DIFF	
14	LVDS_DA2+	DIFF	
15	LVDS_DA3-	DIFF	
16	LVDS_DA3+	DIFF	



Pin	Pin Name	Signal Type	Signal Level
17	DDC_DATA	I/O	+3.3V
18	DDC_CLK	I/O	+3.3V
19	LVDS_DB0-	DIFF	
20	LVDS_DB0+	DIFF	
21	LVDS_DB1-	DIFF	
22	LVDS_DB1+	DIFF	
23	LVDS_DB2-	DIFF	
24	LVDS_DB2+	DIFF	
25	LVDS_DB3-	DIFF	
26	LVDS_DB3+	DIFF	
27	LCD_PWR	PWR	+3.3V/+5V
28	GND	GND	
29	LVDS_B_CLK-	DIFF	
30	LVDS_B_CLK+	DIFF	

## 2.5.9 COM Port 2 (CN9)

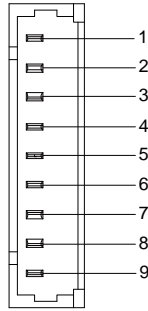

### RS-232

Pin	Pin Name	Signal Type	Signal Level
1	DCD2	IN	
2	DSR2	IN	
3	RX2	IN	
4	RTS2	OUT	±5V
5	TX2	OUT	±5V
6	CTS2	IN	
7	DTR2	OUT	±5V
8	RI2/+5V/+12V	IN	+5V/+12V
9	GND	GND	

### RS-485

Pin	Pin Name	Signal Type	Signal Level
1	RS485_D2-	I/O	±5V
2	NC		
3	RS485_D2+	I/O	±5V
4	NC		

5	NC		
6	NC		
7	NC		
8	NC/+5V/+12V	PWR	+5V/+12V
9	GND	GND	

## RS-422

Pin	Pin Name	Signal Type	Signal Level
1	RS422_TX2-	OUT	±5V
2	NC		
3	RS422_TX2+	OUT	±5V
4	NC		
5	RS422_RX2+	IN	
6	NC		
7	RS422_RX2-	IN	
8	NC/+5V/+12V	PWR	+5V/+12V
9	GND	GND	

\* COM2 RS-232/422/485 can be set by BIOS setting. Default is RS-232.

\* Pin 8 function can be set by JP3.

## 2.5.10 LPT Port or Digital I/O Port (CN10)

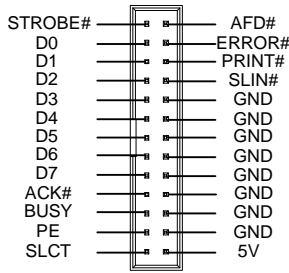

※ LPT or Digital I/O function can be selected by BIOS setting. Default is Digital I/O.

LPT Port			
Pin	Pin Name	Signal Type	Signal Level
1	STROBE#	IN	
2	AFD#	I/O	
3	PD0	I/O	
4	ERROR#	IN	
5	PD1	I/O	
6	PRINT#	I/O	
7	PD2	I/O	
8	SLIN#	I/O	
9	PD3	I/O	
10	GND	GND	
11	PD4	I/O	
12	GND	GND	
13	PD5	I/O	
14	GND	GND	
15	PD6	I/O	
16	GND	GND	

## LPT Port

Pin	Pin Name	Signal Type	Signal Level
17	PD7	I/O	
18	GND	GND	
19	ACK#	IN	
20	GND	GND	
21	BUSY	IN	
22	GND	GND	
23	PE	IN	
24	GND	GND	
25	SLCT	IN	
26	5V	PWR	+5V

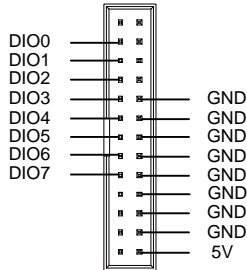

## Digital I/O Port

Pin	Pin Name	Signal Type	Signal Level
1	NC		
2	NC		
3	DIO0	I/O	+5V
4	NC		
5	DIO1	I/O	+5V

Digital I/O Port			
Pin	Pin Name	Signal Type	Signal Level
6	NC		
7	DIO2	I/O	+5V
8	NC		
9	DIO3	I/O	+5V
10	GND	GND	
11	DIO4	I/O	+5V
12	GND	GND	
13	DIO5	I/O	+5V
14	GND	GND	
15	DIO6	I/O	+5V
16	GND	GND	
17	DIO7	I/O	+5V
18	GND	GND	
19	NC		
20	GND	GND	
21	NC		
22	GND	GND	
23	NC		
24	GND	GND	
25	NC		
26	5V	PWR	+5V

## 2.5.11 LPC Port (CN11)

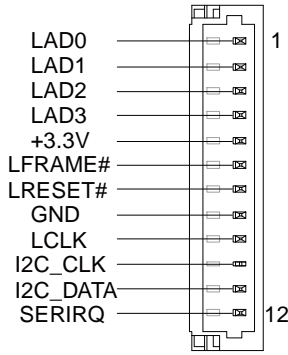

Pin	Pin Name	Signal Type	Signal Level
1	LAD0	I/O	+3.3V
2	LAD1	I/O	+3.3V
3	LAD2	I/O	+3.3V
4	LAD3	I/O	+3.3V
5	+3.3V	PWR	+3.3V
6	LFRAME#	IN	
7	LRESET#	OUT	+3.3V
8	GND	GND	
9	LCLK	OUT	
10	I2C_CLK	OUT	+3.3V
11	I2C_DATA	I/O	+3.3V
12	SERIRQ	I/O	+3.3V

## 2.5.12 COM Port 3 (CN12)

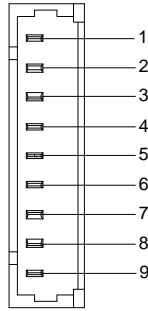

### RS-232

Pin	Pin Name	Signal Type	Signal Level
1	DCD3	IN	
2	DSR3	IN	
3	RX3	IN	
4	RTS3	OUT	±5V
5	TX3	OUT	±5V
6	CTS3	IN	
7	DTR3	OUT	±5V
8	RI3/+5V/+12V	IN	+5V/+12V
9	GND	GND	

### RS-485

Pin	Pin Name	Signal Type	Signal Level
1	RS485_D3-	I/O	±5V
2	NC		
3	RS485_D3+	I/O	±5V



4	NC		
5	NC		
6	NC		
7	NC		
8	NC/+5V/+12V	PWR	+5V/+12V
9	GND	GND	

RS-422			
Pin	Pin Name	Signal Type	Signal Level
1	RS422_TX3-	OUT	±5V
2	NC		
3	RS422_TX3+	OUT	±5V
4	NC		
5	RS422_RX3+	IN	
6	NC		
7	RS422_RX3-	IN	
8	NC/+5V/+12V	PWR	+5V/+12V
9	GND	GND	

\* COM3 RS-232/422/485 can be set by BIOS setting. Default is RS-232.

\* Pin 8 function can be set by JP4.

## 2.5.13 BIOS Debug Port (CN13)

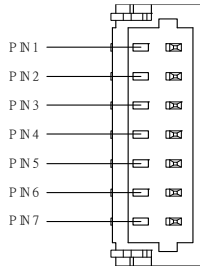

Pin	Pin Name	Signal Type	Signal Level
1	SPI_MISO	OUT	
2	GND	GND	
3	SPI_CLK	IN	
4	+3.3VSB	PWR	+3.3V
5	SPI_MOSI	IN	
6	SPI_CS	IN	
7	NC		

## 2.5.14 COM Port 4 (CN14)

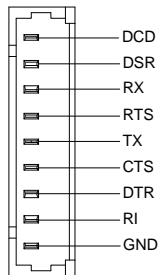

Pin	Pin Name	Signal Type	Signal Level
1	DCD4	IN	
2	DSR4	IN	
3	RX4	IN	

4	RTS4	OUT	±9V
5	TX4	OUT	±9V
6	CTS4	IN	
7	DTR4	OUT	±9V
8	RI4	IN	
9	GND	GND	

### 2.5.15PS/2 Keyboard/Mouse Combo Port (CN15)

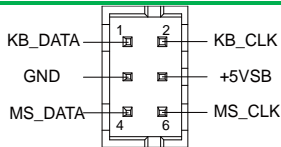

Pin	Pin Name	Signal Type	Signal Level
1	KB_DATA	I/O	+5V
2	KB_CLK	I/O	+5V
3	GND	GND	
4	+5VSB	PWR	+5V
5	MS_DATA	I/O	+5V
6	MS_CLK	I/O	+5V

## 2.5.16 USB 2.0 Port 2 (CN16)

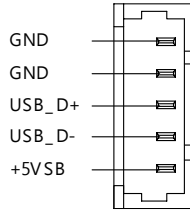

Pin	Pin Name	Signal Type	Signal Level
1	+5VSB	PWR	+5V
2	USB_D-	DIFF	
3	USB_D+	DIFF	
4	GND	GND	
5	GND	GND	

## 2.5.17 USB 2.0 Port 3 (CN17)

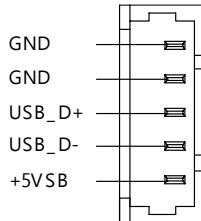

Pin	Pin Name	Signal Type	Signal Level
1	+5VSB	PWR	+5V
2	USB_D-	DIFF	
3	USB_D+	DIFF	
4	GND	GND	
5	GND	GND	

## 2.5.18COM Port 1 (CN18) (Wafer, Optional)

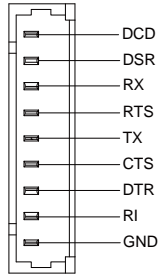

Pin	Pin Name	Signal Type	Signal Level
1	DCD1	IN	
2	DSR1	IN	
3	RX1	IN	
4	RTS1	OUT	±9V
5	TX1	OUT	±9V
6	CTS1	IN	
7	DTR1	OUT	±9V
8	RI1	IN	
9	GND	GND	

### 2.5.19 USB 2.0 Port 4 (CN19)

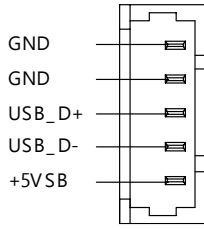

Pin	Pin Name	Signal Type	Signal Level
1	+5VSB	PWR	+5V
2	USB_D-	DIFF	
3	USB_D+	DIFF	
4	GND	GND	
5	GND	GND	

### 2.5.20 USB 2.0 Port 5 (CN20)

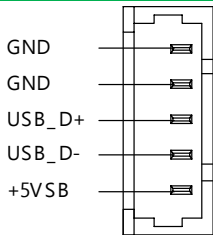

Pin	Pin Name	Signal Type	Signal Level
1	+5VSB	PWR	+5V
2	USB_D-	DIFF	
3	USB_D+	DIFF	
4	GND	GND	
5	GND	GND	

## 2.5.21LVDS Port 2 (CN21)

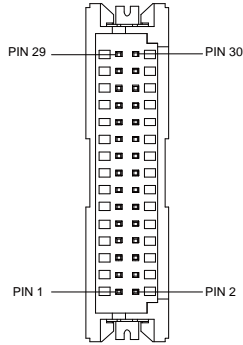

\*LVDS2 LCD\_PWR can be set to +3.3V or +5V by JP7

Pin	Pin Name	Signal Type	Signal Level
1	BKL_ENABLE	OUT	
2	BKL_CONTROL	OUT	
3	LCD_PWR	PWR	+3.3V/+5V
4	GND	GND	
5	LVDS_A_CLK-	DIFF	
6	LVDS_A_CLK+	DIFF	
7	LCD_PWR	PWR	+3.3V/+5V
8	GND	GND	
9	LVDS_DA0-	DIFF	
10	LVDS_DA0+	DIFF	
11	LVDS_DA1-	DIFF	
12	LVDS_DA1+	DIFF	
13	LVDS_DA2-	DIFF	
14	LVDS_DA2+	DIFF	
15	LVDS_DA3-	DIFF	
16	LVDS_DA3+	DIFF	

Pin	Pin Name	Signal Type	Signal Level
17	DDC_DATA	I/O	+3.3V
18	DDC_CLK	I/O	+3.3V
19	LVDS_DB0-	DIFF	
20	LVDS_DB0+	DIFF	
21	LVDS_DB1-	DIFF	
22	LVDS_DB1+	DIFF	
23	LVDS_DB2-	DIFF	
24	LVDS_DB2+	DIFF	
25	LVDS_DB3-	DIFF	
26	LVDS_DB3+	DIFF	
27	LCD_PWR	PWR	+3.3V/+5V
28	GND	GND	
29	LVDS_B_CLK-	DIFF	
30	LVDS_B_CLK+	DIFF	



## 2.5.22 Touchscreen Connector (CN22)

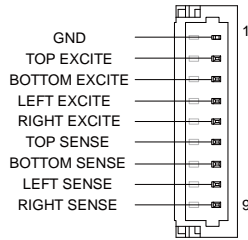

### 8-Wire

Pin	Pin Name	Signal Type	Signal Level
1	GND	GND	
2	TOP EXCITE	IN	
3	BOTTOM EXCITE	IN	
4	LEFT EXCITE	IN	
5	RIGHT EXCITE	IN	
6	TOP SENSE	IN	
7	BOTTOM SENSE	IN	
8	LEFT SENSE	IN	
9	RIGHT SENSE	IN	

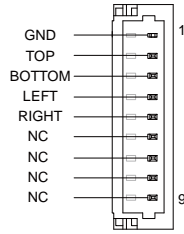

## 4-Wire

Pin	Pin Name	Signal Type	Signal Level
1	GND	GND	
2	TOP	IN	
3	BOTTOM	IN	
4	LEFT	IN	
5	RIGHT	IN	
6	NC		
7	NC		
8	NC		
9	NC		

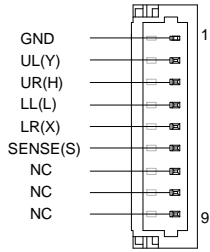

## 5-Wire

Pin	Pin Name	Signal Type	Signal Level
1	GND	GND	
2	UL(Y)	IN	
3	UR(H)	IN	
4	LL(L)	IN	
5	LR(X)	IN	
6	SENSE(S)	IN	
7	NC		
8	NC		
9	NC		

### 2.5.23 CPU Fan (CN23, Optional)

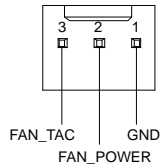

Pin	Pin Name	Signal Type	Signal Level
1	GND	GND	
2	FAN_POWER	PWR	+12V
3	FAN_TAC	IN	

### 2.5.24 LVDS Port 2 Inverter / Backlight Connector (CN24)

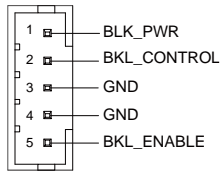

Pin	Pin Name	Signal Type	Signal level
1	BKL_PWR	PWR	+5V / +12V
2	BKL_CONTROL	OUT	
3	GND	GND	
4	GND	GND	
5	BKL_ENABLE	OUT	+5V

\* LVDS2 BKL\_PWR can be set to +5V or +12V by JP7

\* LVDS2 BKL\_CONTROL can be set by JP8

## 2.5.25 USB 3.0 Ports 0 and 1 (CN25)

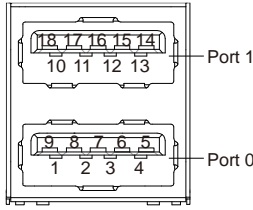

Pin	Pin Name	Signal Type	Signal Level
1	+5VSB	PWR	+5V
2	USB_D-	DIFF	
3	USB_D+	DIFF	
4	GND	GND	
5	USB_SSRX-	DIFF	
6	USB_SSRX+	DIFF	
7	GND	GND	
8	USB_SSTX-	DIFF	
9	USB_SSTX+	DIFF	
10	+5VSB	PWR	+5V
11	USB_D-	DIFF	
12	USB_D+	DIFF	
13	GND	GND	
14	USB_SSRX-	DIFF	
15	USB_SSRX+	DIFF	
16	GND	GND	
17	USB_SSTX-	DIFF	
18	USB_SSTX+	DIFF	

### 2.5.26 LAN (RJ-45) Port 2 (CN26)

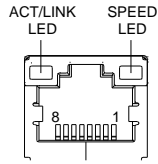

Pin	Pin Name	Signal Type	Signal level
1	MDI0+	DIFF	
2	MDI0-	DIFF	
3	MDI1+	DIFF	
4	MDI2+	DIFF	
5	MDI2-	DIFF	
6	MDI1-	DIFF	
7	MDI3+	DIFF	
8	MDI3-	DIFF	

### 2.5.27 LAN (RJ-45) Port 1 (CN27)

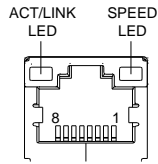

Pin	Pin Name	Signal Type	Signal level
1	MDI0+	DIFF	
2	MDI0-	DIFF	
3	MDI1+	DIFF	
4	MDI2+	DIFF	
5	MDI2-	DIFF	
6	MDI1-	DIFF	

7	MDI3+	DIFF
8	MDI3-	DIFF

### 2.5.28 COM Port 1 (CN28, D-SUB 9)

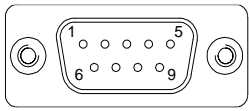

Pin	Pin Name	Signal Type	Signal level
1	DCD	IN	
2	RX	IN	
3	TX	OUT	±9V
4	DTR	OUT	±9V
5	GND	GND	
6	DSR	IN	
7	RTS	OUT	±9V
8	CTS	IN	
9	RI	IN	

## 2.5.29 HDMI Port (CN29, Optional)

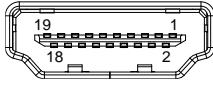

Pin	Pin Name	Signal Type	Signal level
1	TMDS_DAT2+	DIFF	
2	GND	GND	
3	TMDS_DAT2-	DIFF	
4	TMDS_DAT1+	DIFF	
5	GND	GND	
6	TMDS_DAT1-	DIFF	
7	TMDS_DAT0+	DIFF	
8	GND	GND	
9	TMDS_DAT0-	DIFF	
10	TMDS_CLK+	DIFF	
11	GND	GND	
12	TMDS_CLK-	DIFF	
13	NC		
14	NC		
15	DDC_CLK	I/O	+5V
16	DDC_DATA	I/O	+5V
17	GND	GND	
18	+5V	I/O	+5V
19	HPLG_DETECT	IN	



### 2.5.30 Battery (CN30)

Pin	Pin Name	Signal Type	Signal level
1	+3.3V	PWR	3.3V
2	GND	GND	

### 2.5.31VGA Port (CN31)

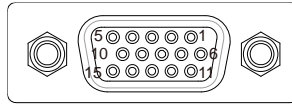

Pin	Pin Name	Signal Type	Signal level
1	RED	OUT	
2	GREEN	OUT	
3	BLUE	OUT	
4	NC		
5	GND	GND	
6	RED_GND_RTN	GND	
7	GREEN_GND_RTN	GND	
8	BLUE_GND_RTN	GND	
9	+5V	PWR	+5V
10	NC		
11	NC		
12	DDC_DATA	I/O	+5V
13	HSYNC	OUT	
14	VSYNC	OUT	
15	DDC_CLK	I/O	+5V

### 2.5.32 Micro SIM Card Socket (CN32)

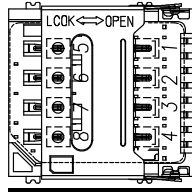

Pin	Pin Name	Signal Type	Signal level
1	UIM_PWR	PWR	
2	UIM_RST	IN	
3	UIM_CLK	IN	
4	NC		
5	GND	GND	
6	UIM_VPP	PWR	
7	UIM_DATA	I/O	
8	NC		

### 2.5.33 Mini-Card Slot (Half-Mini) (CN33)

Pin	Pin Name	Signal Type	Signal level
1	PCIE_WAKE#	IN	
2	+3.3VSB	PWR	+3.3V
3	NC		
4	GND	GND	
5	NC		
6	+1.5V	PWR	+1.5V
7	PCIE_CLK_REQ#	IN	

Pin	Pin Name	Signal Type	Signal level
8	UIM_PWR	PWR	
9	GND	GND	
10	UIM_DATA	I/O	
11	PCIE_REF_CLK-	DIFF	
12	UIM_CLK	IN	
13	PCIE_REF_CLK+	DIFF	
14	UIM_RST	IN	
15	GND	GND	
16	UIM_VPP	PWR	
17	NC		
18	GND	GND	
19	NC		
20	W_DISABLE#	OUT	+3.3V
21	GND	GND	
22	PCIE_RST#	OUT	+3.3V
23	PCIE_RX-	DIFF	
24	+3.3VSB	PWR	+3.3V
25	PCIE_RX+	DIFF	
26	GND	GND	
27	GND	GND	
28	+1.5V	PWR	+1.5V
29	GND	GND	
30	SMB_CLK	I/O	+3.3V
31	PCIE_TX-	DIFF	
32	SMB_DATA	I/O	+3.3V
33	PCIE_TX+	DIFF	

Pin	Pin Name	Signal Type	Signal level
34	GND	GND	
35	GND	GND	
36	USB_D-	DIFF	
37	GND	GND	
38	USB_D+	DIFF	
39	+3.3VSB	PWR	+3.3V
40	GND	GND	
41	+3.3VSB	PWR	+3.3V
42	NC		
43	GND	GND	
44	NC		
45	NC		
46	NC		
47	NC		
48	+1.5V	PWR	+1.5V
49	NC		
50	GND	GND	
51	NC		
52	+3.3VSB	PWR	+3.3V

### 2.5.34 mSATA (Full-Size) (CN34)

※ CN34 can be changed to mini-card by BOM change.

Pin	Pin Name	Signal Type	Signal Level
1	NC	IN	
2	+3.3V	PWR	+3.3V
3	NC		
4	GND	GND	
5	NC		
6	+1.5V	PWR	+1.5V
7	NC		
8	NC		
9	GND	GND	
10	NC		
11	NC		
12	NC		
13	NC		
14	NC		
15	GND	GND	
16	NC		
17	NC		
18	GND	GND	
19	NC		GND
20	NC		
21	GND	GND	
22	NC	OUT	
23	SATA_RX+	DIFF	
24	+3.3V	PWR	+3.3V

Pin	Pin Name	Signal Type	Signal Level
25	SATA_RX-	DIFF	
26	GND	GND	
27	GND	GND	
28	+1.5V	PWR	+1.5V
29	GND	GND	
30	SMB_CLK	I/O	+3.3V
31	SATA_TX-	DIFF	
32	SMB_DATA	I/O	+3.3V
33	SATA_TX+	DIFF	
34	GND	GND	
35	GND	GND	
36	NC		
37	GND	GND	
38	NC		
39	+3.3V	PWR	+3.3V
40	GND	GND	
41	+3.3V	PWR	+3.3V
42	NC		
43	GND	GND	
44	NC		
45	NC		
46	NC		
47	NC		
48	+1.5V	PWR	+1.5V
49	NC		
50	GND	GND	

Pin	Pin Name	Signal Type	Signal Level
51	NC		
52	+3.3V	PWR	+3.3V

# Chapter 3

---

AMI BIOS Setup



## 3.1 System Test and Initialization

---

These routines test and initialize board hardware. If the routines encounter an error during the tests, you will either hear a few short beeps or see an error message on the screen. There are two kinds of errors: fatal and non-fatal. The system can usually continue the boot up sequence with non-fatal errors.

### System configuration verification

These routines check the current system configuration stored in the CMOS memory and BIOS NVRAM. If system configuration is not found or system configuration data error is detected, system will load optimized default and re-boot with this default system configuration automatically.

There are four situations in which you will need to setup system configuration:

1. You are starting your system for the first time
2. You have changed the hardware attached to your system
3. The system configuration is reset by Clear-CMOS jumper
4. The CMOS memory has lost power and the configuration information has been erased.

The GENE-APL5 CMOS memory has an integral lithium battery backup for data retention. However, you will need to replace the complete unit when it finally runs down.

## 3.2 AMI BIOS Setup

---

AMI BIOS ROM has a built-in Setup program that allows users to modify the basic system configuration. This type of information is stored in battery-backed CMOS RAM and BIOS NVRAM so that it retains the Setup information when the power is turned off.

### Entering Setup

Power on the computer and press <Del> or <ESC> immediately. This will allow you to enter Setup.

**Main** – Set the date, use tab to switch between date elements.

**Advanced** – Enable/disable boot option for legacy network devices.

**Chipset** – Host bridge parameters.

**Boot** – Enable/Disable quiet Boot Option

**Security** – Set setup administrator password.

**Save & Exit** – Save your changes and exit the program

### 3.3 Setup submenu: Main

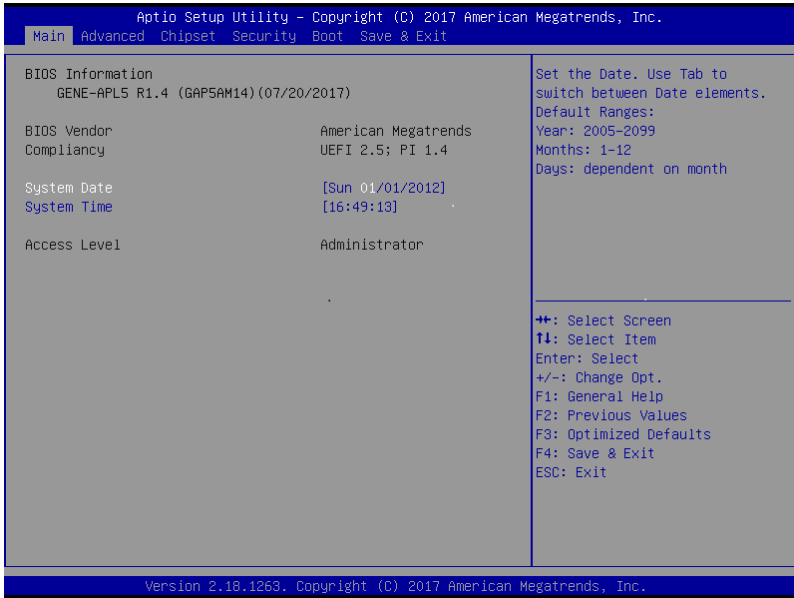

### 3.4 Setup submenu: Advanced

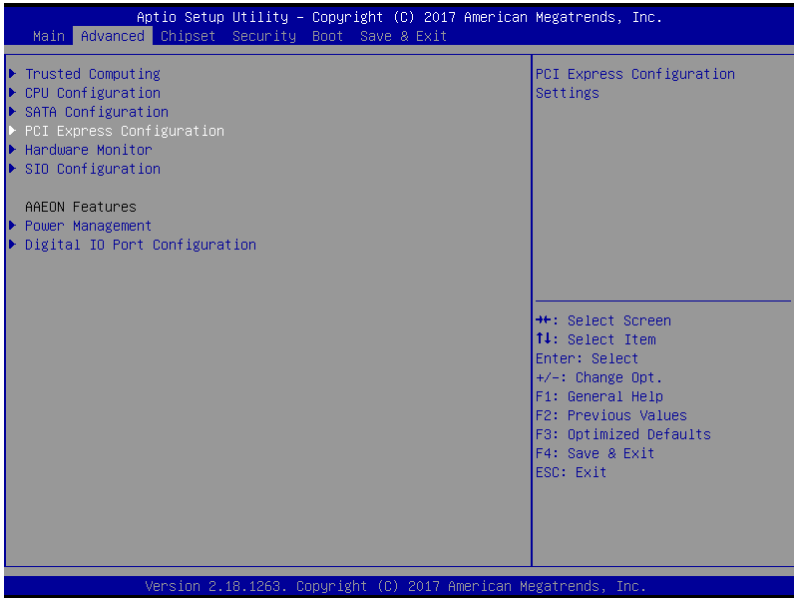

### 3.4.1 Advanced: Trusted Computing



Options summary:

Security Device Support	Disable	
	Enable	Optimal Default, Failsafe Default
Enables or Disables BIOS support for security device. O.S. will not show Security Device. TCG EFI protocol and INT1A interface will not be available.		
SHA-1 PCR Bank	Disable	
	Enable	Optimal Default, Failsafe Default
Enable or Disable SHA-1 PCR Bank		
SHA256 PCR Bank	Disable	
	Enable	Optimal Default, Failsafe Default
Enable or Disable SHA256 PCR Bank		
Pending Operation	None	Optimal Default, Failsafe Default
	TPM Clear	
Schedule an Operation for the Security Device. NOTE: Your Computer will reboot during restart in order to change State of Security Device.		

Platform Hierarchy	Disabled	
	Enabled	Optimal Default, Failsafe Default
Enable or disable Platform Hierarchy		
Storage Hierarchy	Disabled	
	Enabled	Optimal Default, Failsafe Default
Enable or Disable Storage Hierarchy		
Endorsement Hierarchy	Disabled	
	Enabled	Optimal Default, Failsafe Default
Enable or Disable Endorsement Hierarchy		
TPM2.0 UEFI Spec Version	TCG_1_2	
	TCG_2	Optimal Default, Failsafe Default
Select the TCG2 Spec Version Support, TCG_1_2: the Compatible mode for Win8/Win10 TCG_2: Support new TCG2 protocol and event format for Win10 or later		
Physical Presence Spec Version	1.2	
	1.3	Optimal Default, Failsafe Default
Select to Tell O.S. to support PPI Spec Version 1.2 or 1.3. Note some HCK tests might not support 1.3.		

### 3.4.2 Advanced: CPU Configuration

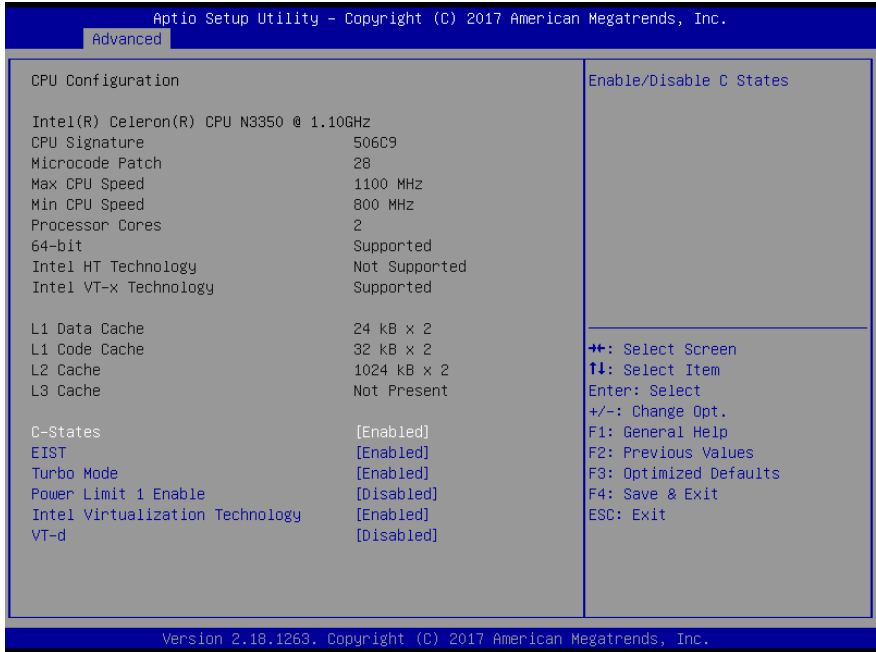

Options summary:

C-States	Disabled	
	Enabled	Optimal Default, Failsafe Default
Enable/Disable C States.		
EIST™	Disabled	
	Enabled	Optimal Default, Failsafe Default
Enable/Disable Intel SpeedStep.		
Turbo Mode	Disabled	
	Enabled	Optimal Default, Failsafe Default
Turbo Mode		
Power Limit 1 Enable	Disabled	Optimal Default, Failsafe Default
	Enabled	
Enable/Disable Power Limit 1		
Intel Virtualization Technology	Disabled	
	Enabled	Optimal Default, Failsafe Default
When enabled, a VMM can utilize the additional hardware capabilities provided by Vanderpool Technology.		

VT-d	Disabled	Optimal Default, Failsafe Default
	Enabled	
Enable/Disable CPU VT-d		



### 3.4.3 Advanced: SATA Configuration



Options summary:

Chipset SATA	Disabled	
	Enabled	Optimal Default, Failsafe Default
Enables or Disables the Chipset SATA Controller. The Chipset SATA controller supports the 2 black internal SATA ports (up to 3Gb/s supported per port).		
Port 0	Disabled	
	Enabled	Optimal Default, Failsafe Default
Enable or Disable SATA Port		
SATA Port 0 Hot Plug Capability	Disabled	Optimal Default, Failsafe Default
	Enabled	
If enabled, SATA port will be reported as Hot Plug capable.		

Port 1	Disabled	
	Enabled	Optimal Default, Failsafe Default
Enable or Disable SATA Port		
SATA Port 0 Hot	Disabled	Optimal Default, Failsafe Default

Plug Capability	Enabled	
If enabled, SATA port will be reported as Hot Plug capable.		

### 3.4.3.1 PCI Express Configuration

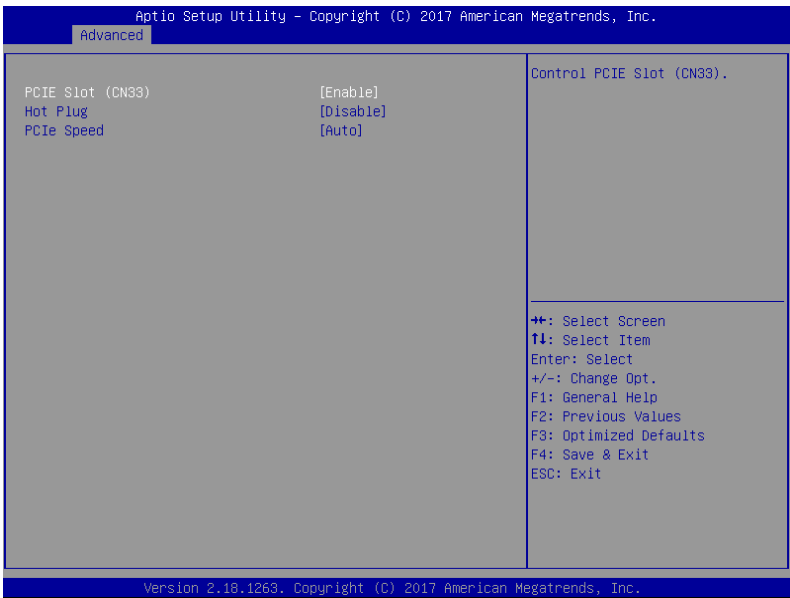
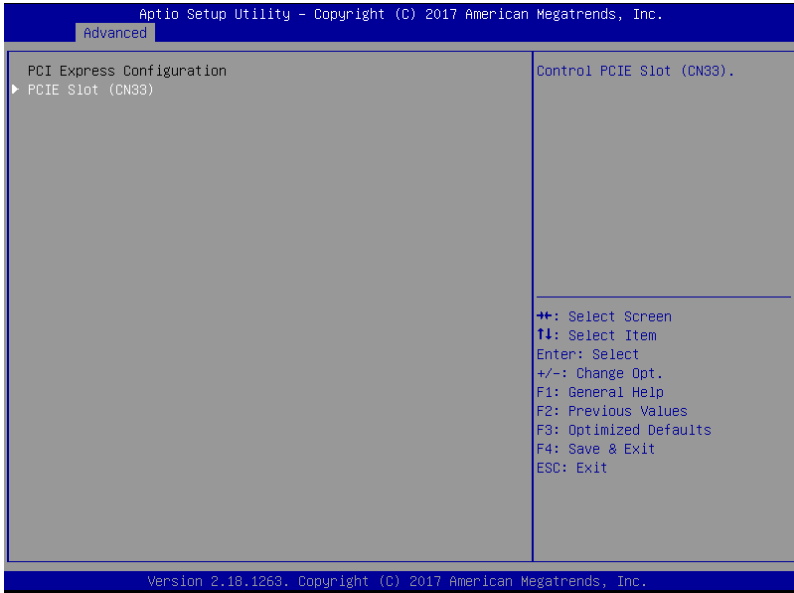

Options summary:

PCIe Slot (CN33)	Disabled	
	Enabled	Optimal Default, Failsafe Default
Control PCIe Slot (CN33)		
Hot Plug	Disabled	Optimal Default, Failsafe Default
	Enabled	
PCIe Express Hot Plug Enable/Disable		
PCIe Speed	Auto	Optimal Default, Failsafe Default
	Gen 1	
	Gen 2	
Configure PCIe Speed		

### 3.4.4 Advanced: Hardware Monitor

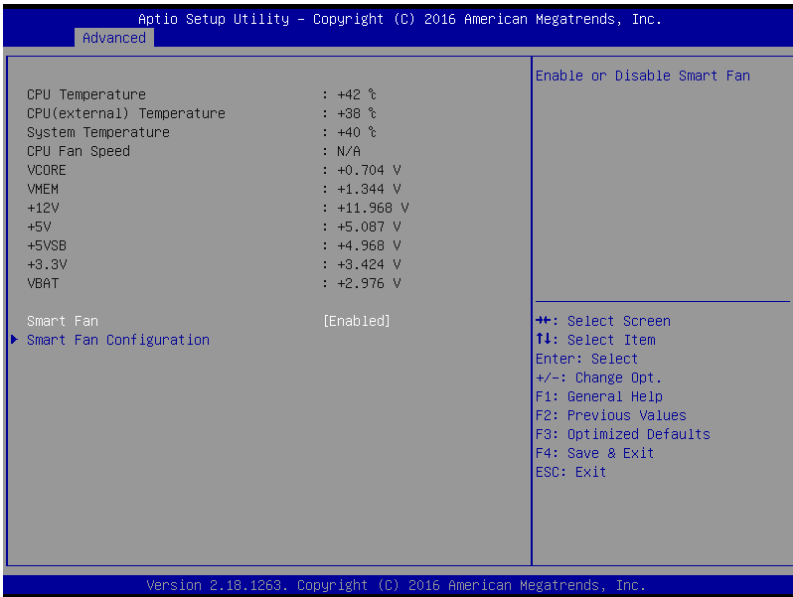

Options summary:

Smart Fan	Disable	
	Enable	Optimal Default, Failsafe Default
Enables or Disables Smart Fan.		

### 3.4.4.1 CPU Smart Fan Configuration

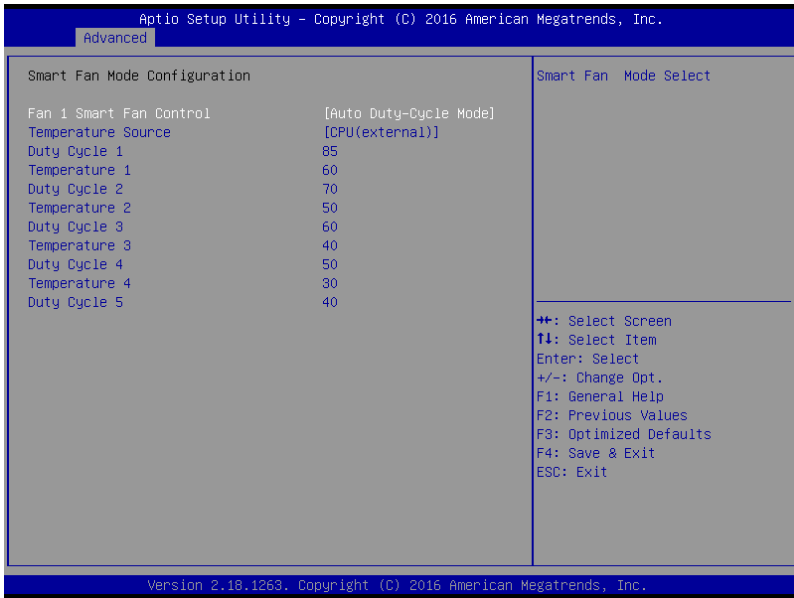

Options summary:

Fan 1 Smart Fan Control	Manual Duty Mode	
	Auto Duty-Cycle Mode	Optimal Default, Failsafe Default
Smart Fan Mode Select		
Temperature Source	CPU	
	CPU(external)	Optimal Default, Failsafe Default
	System	
Select the monitored temperature source for this fan.		
Duty Cycle 1	85	
Temperature 1	60	
Auto fan speed control. Fan speed will follow different temperature by different duty cycle 1-100		

### 3.4.5 Advanced: SIO Configuration

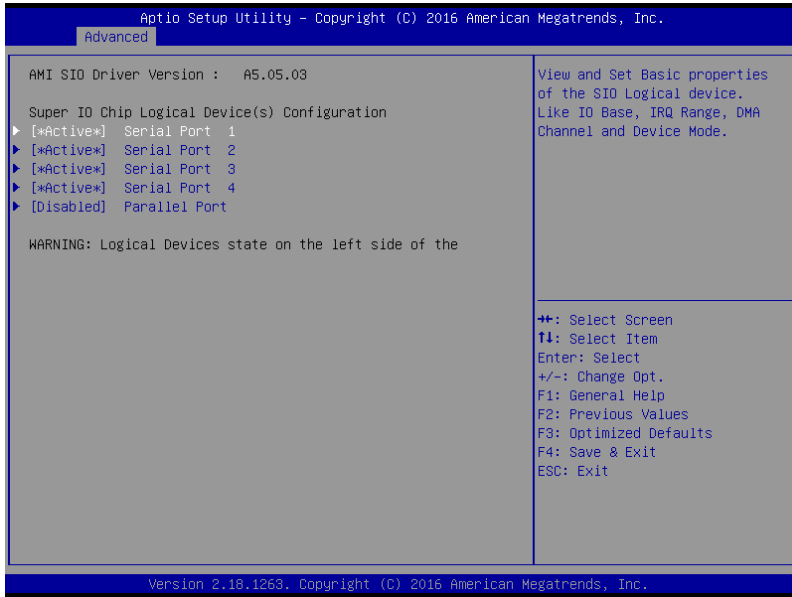

### 3.4.5.1 SIO Configuration: Serial Port 1 Configuration

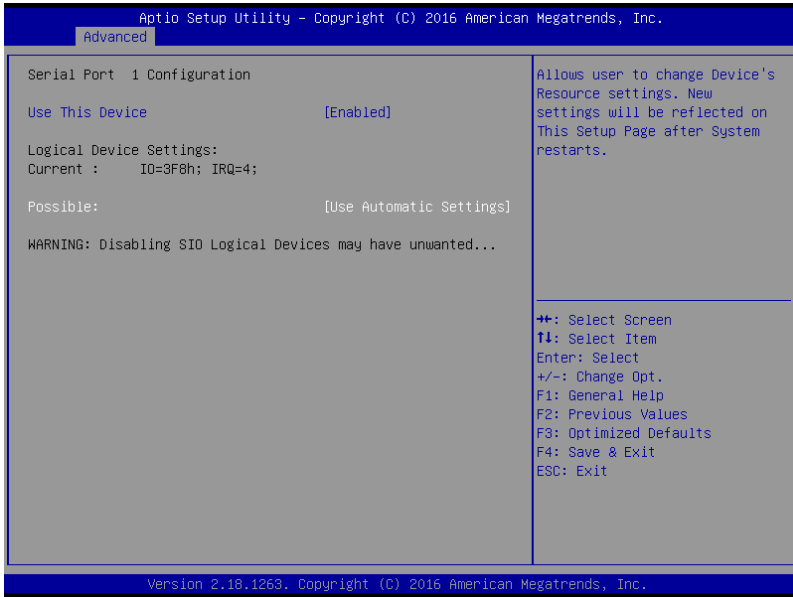

Options summary:

Use This Device	Disable	
	Enable	Optimal Default, Failsafe Default
Enable or Disable this Logical Device.		
Possible:	Use Automatic Settings	Optimal Default, Failsafe Default
	IO=3F8h; IRQ=4	
	IO=2F8h; IRQ=3	
Allows user to change Device's Resource settings. New settings will be reflected on This Setup Page after System restarts.		

### 3.4.5.2 SIO Configuration: Serial Port 2 Configuration

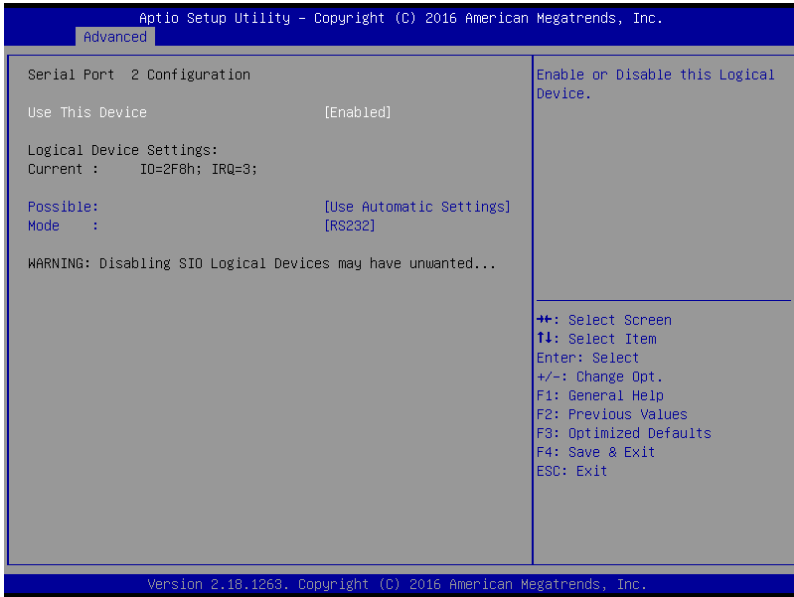

Options summary:

Use This Device	Disable	
	Enable	Optimal Default, Failsafe Default
Enable or Disable this Logical Device.		
Possible:	Use Automatic Settings	Optimal Default, Failsafe Default
	IO=2F8h; IRQ=3	
	IO=3F8h; IRQ=4	
Allows user to change Device's Resource settings. New settings will be reflected on This Setup Page after System restarts.		
Mode:	RS232	Optimal Default, Failsafe Default
	RS422	
	RS485	
UART RS232, 422, 485 selection.		



### 3.4.5.3 SIO Configuration: Serial Port 3 Configuration

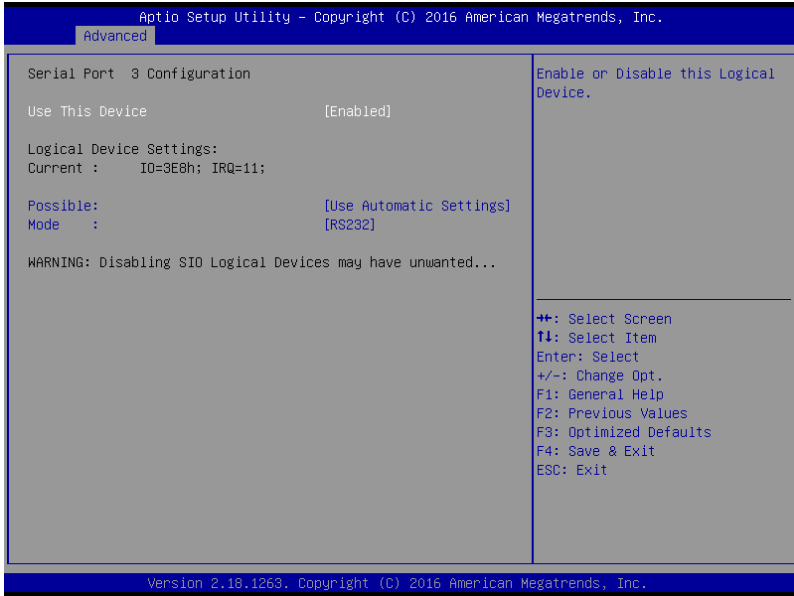

Options summary:

Use This Device	Disable	
	Enable	Optimal Default, Failsafe Default
Enable or Disable this Logical Device.		
Possible:	Use Automatic Settings	Optimal Default, Failsafe Default
	IO=3E8h; IRQ=11	
	IO=2E8h; IRQ=11	
Allows user to change Device's Resource settings. New settings will be reflected on This Setup Page after System restarts.		
Mode:	RS232	Optimal Default, Failsafe Default
	RS422	
	RS485	
UART RS232, 422, 485 selection.		

### 3.4.5.4 SIO Configuration: Serial Port 4 Configuration

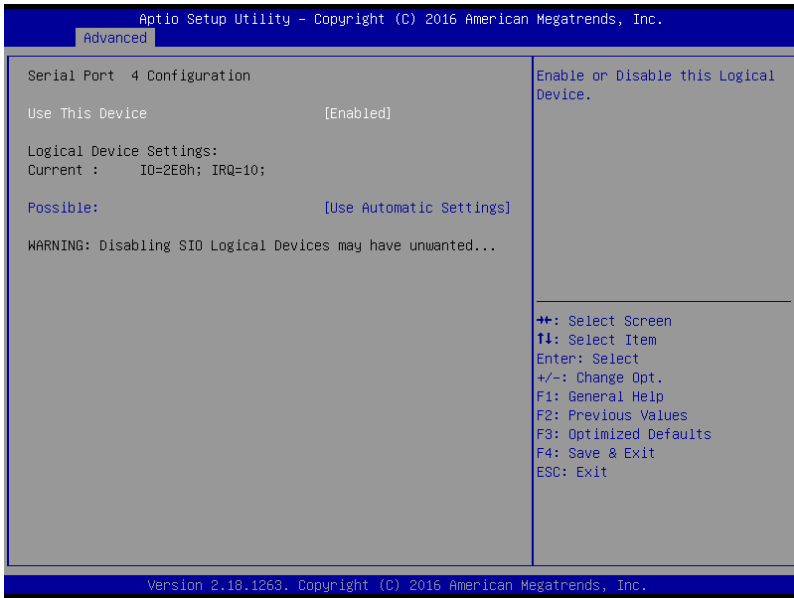

Options summary:

Use This Device	Disable	
	Enable	Optimal Default, Failsafe Default
Enable or Disable this Logical Device.		
Possible:	Use Automatic Settings	Optimal Default, Failsafe Default
	IO=2E8h; IRQ=10	
	IO=3E8h; IRQ=10	
Allows user to change Device's Resource settings. New settings will be reflected on This Setup Page after System restarts.		

### 3.4.5.5 SIO Configuration: Parallel Port Configuration



Options summary:

Use This Device	Disable	
	Enable	Optimal Default, Failsafe Default
Enable or Disable this Logical Device.		

### 3.4.6 Advanced: Power Management

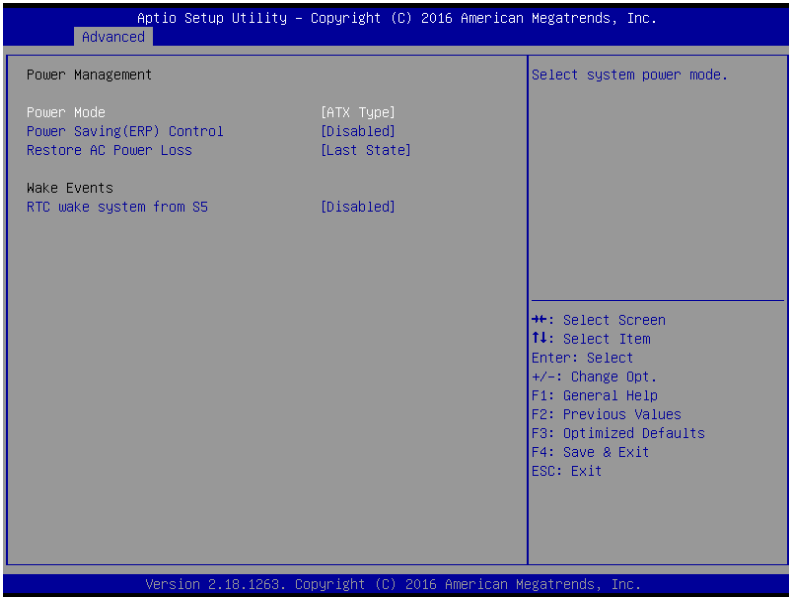

Options summary:

Power Mode	ATX Type	Optimal Default, Failsafe Default
	AT Type	
Select system power mode		
Power Saving(ERP) Control	Disabled	Optimal Default, Failsafe Default
	Enabled	
Configure power mode for power saving function.		
Restore AC Power Loss	Last State	Optimal Default, Failsafe Default
	Always On	
	Always Off	
RTC wake system from S5	Disable	Optimal Default, Failsafe Default
	Fixed Time	
Select system power mode		

### 3.4.7 Advanced: Digital IO Port Configuration

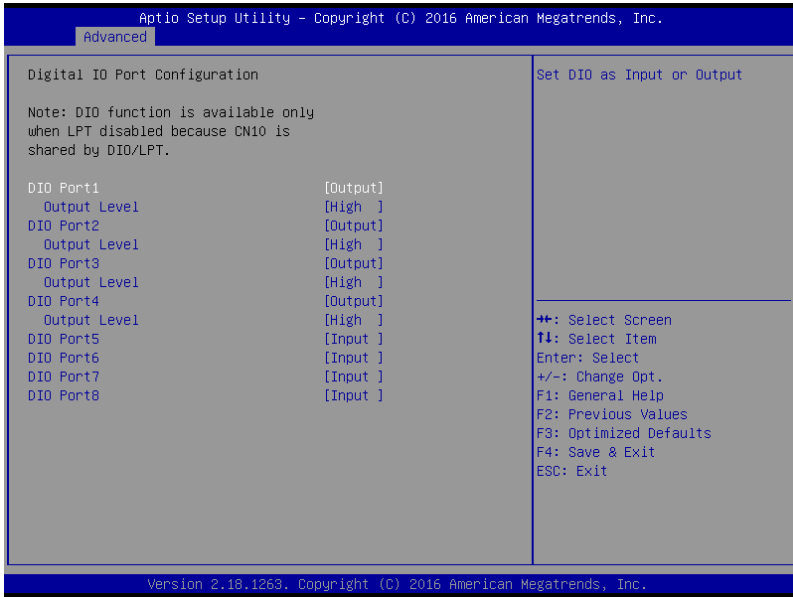

Options summary:

DIO Port*	Output	
	Input	
Set DIO as Input or Output		
Output Level	High	Optimal Default, Failsafe Default
	Low	
Set output level when DIO pin is output		

### 3.5 Setup submenu: Chipset

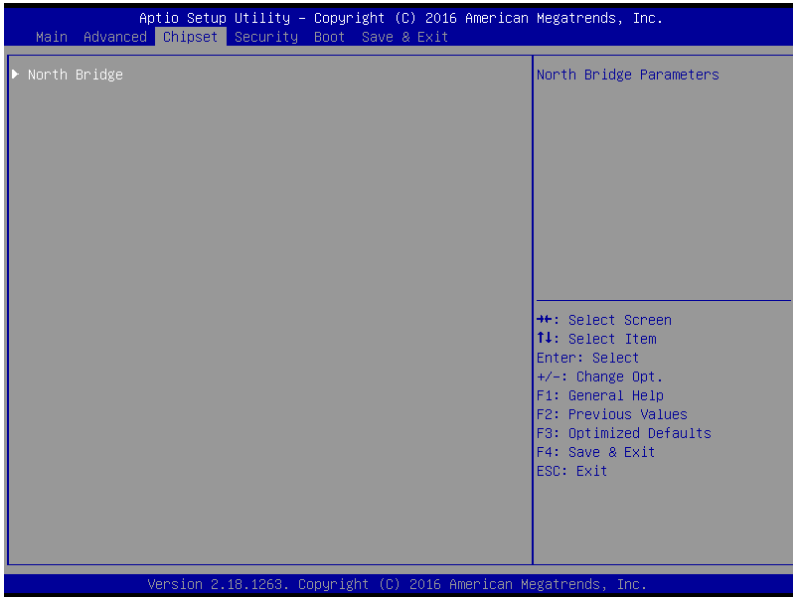

### 3.5.1 Chipset: North Bridge



### 3.5.1.1 North Bridge: LVDS Panel Configuration

\* LVDS2 only available for 2 LVDS SKU

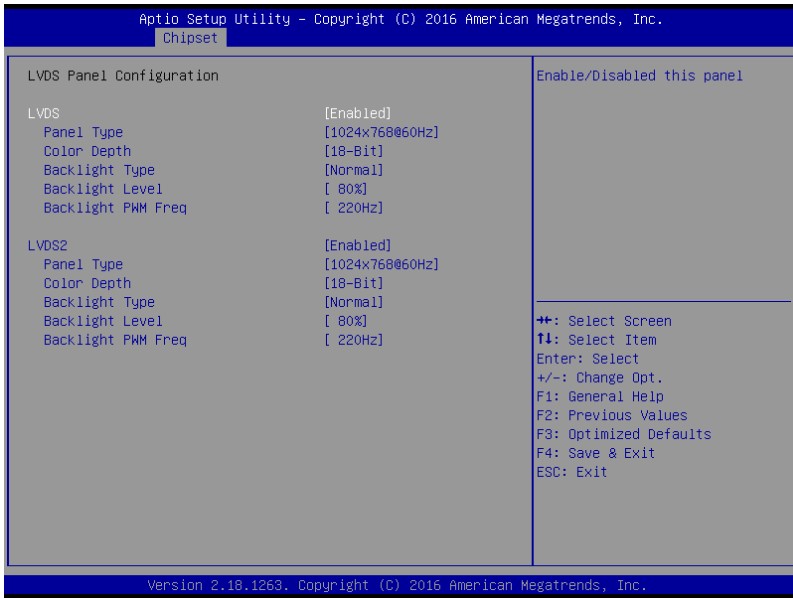

Options summary:

LVDS	Disabled	Optimal Default, Failsafe Default
	Enabled	
Enable/Disabled this panel.		
LVDS Panel Type	640x480@60Hz	Optimal Default, Failsafe Default
	800x480@60Hz	
	800x600@60Hz	
	1024x600@60Hz	
	1024x768@60Hz	
	1280x768@60Hz	
	1280x800@60Hz	
	1280x1024@60Hz	
	1366x768@60Hz	
	1440x900@60Hz	
	1600x1200@60Hz	
	1920x1080@60Hz	
	1920x1200@60Hz	



Select LCD panel used by Internal Graphics Device by selecting the appropriate setup item.

Color Depth	18-bit	Optimal Default, Failsafe Default
	24-bit	
	36-bit	
	48-bit	
Select panel type		
Backlight Type	Normal	Optimal Default, Failsafe Default
	Inverted	
Select backlight control signal type		
Backlight Level	0%	Optimal Default, Failsafe Default
	10%	
	20%	
	30%	
	40%	
	50%	
	60%	
	70%	
	80%	
	90%	
100%		
Select backlight control level		
Backlight PWM Freq	100Hz	Optimal Default, Failsafe Default
	200Hz	
	220Hz	
	500Hz	
	1KHz	
	2.2KHz	
	6.5KHz	
Select PWM frequency of backlight control signal		

## 3.6 Setup submenu: Security

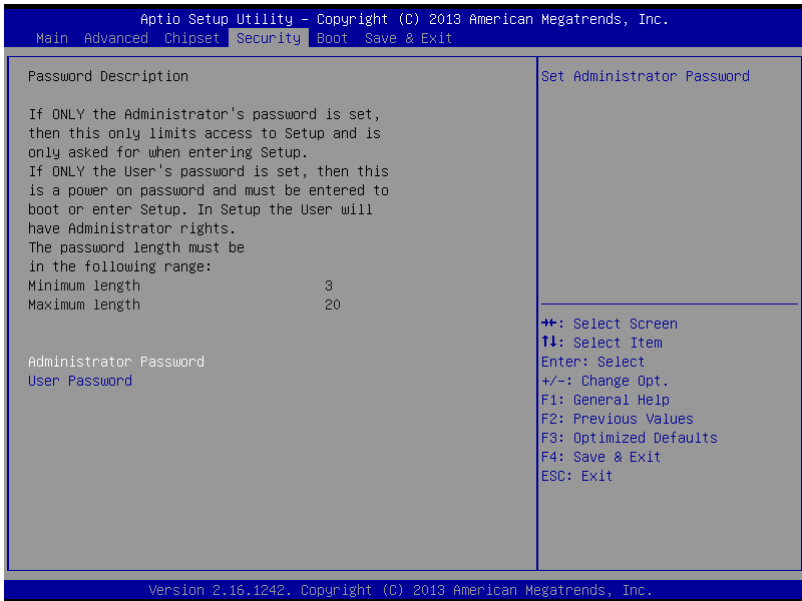

### Change User/Supervisor Password

You can install a Supervisor password, and if you install a supervisor password, you can then install a user password. A user password does not provide access to many of the features in the Setup utility.

If you highlight these items and press Enter, a dialog box appears which lets you enter a password. You can enter no more than six letters or numbers. Press Enter after you have typed in the password. A second dialog box asks you to retype the password for confirmation. Press Enter after you have retyped it correctly. The password is required at boot time, or when the user enters the Setup utility.

### Removing the Password

Highlight this item and type in the current password. At the next dialog box press Enter to disable password protection.

### 3.7 Setup submenu: Boot



Options summary:

Quiet Boot	Disabled	Optimal Default, Failsafe Default
	Enabled	
Enable/Disable showing boot logo.		
Monitor Mwait	Disable	Optimal Default, Failsafe Default
	Enabled	
	Auto	
Enable/Disable Monitor Mwait. To install Linux OS, please set this item to disable.		
Ipv4 PXE Support	Disabled	Optimal Default, Failsafe Default
	Enabled	
Enable Ipv4 PXE Boot Support. If disabled IPV4 PXE boot option will not be created.		

### 3.8 Setup submenu: Save & Exit

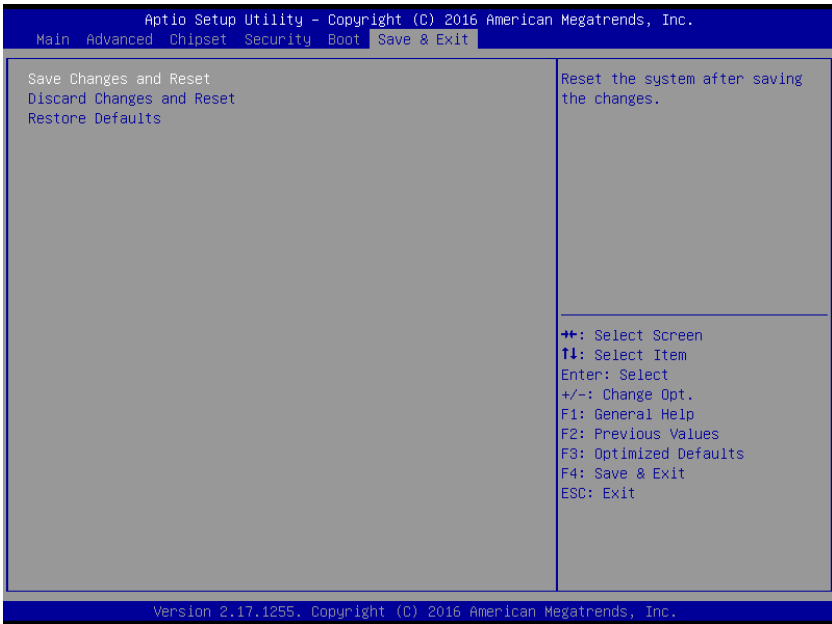

### 3.9 Note for Users

---

1. To Install Linux OS, set the **Monitor Mwait** to Disabled (Boot->Monitor Mwait->[Disabled])

# Chapter 4

---

Drivers Installation

## 4.1 Product CD/DVD

---

The GENE-APL5 comes with a product DVD that contains all the drivers and utilities you need to setup your product. Insert the DVD and follow the steps in the autorun program to install the drivers.

In case the program does not start, follow the sequence below to install the drivers.

### Step 1 – Install Chipset Drivers

1. Open the **Step1 - Chipset** folder followed by **SetupChipset.exe**
2. Follow the instructions
3. Drivers will be installed automatically

### Step 2 – Install Graphics Drivers

1. Open the **Step2 - VGA** folder followed by **Setup.exe**
2. Follow the instructions
3. Drivers will be installed automatically

### Step 3 – Install LAN Drivers

1. Click on the **Step3 - LAN** folder and select your OS
2. Open the **.exe** file in the folder
3. Follow the instructions
4. Drivers will be installed automatically

### Step 4 – Install Audio Drivers

1. Open the **Step4 - Audio** folder followed by **0006-64bit\_Win7\_Win8\_Win81\_Win10\_R279.exe**
2. Follow the instructions

3. Drivers will be installed automatically

#### Step 5 – Install TXE Driver

1. Open the **Step5 - TXE** folder followed by **SetupTXE.exe**
2. Follow the instructions
3. Drivers will be installed automatically

#### Step 6 – Install Touch Driver

1. Open the **Step6 - Touch** folder followed by **Setup.exe**
2. Follow the instructions
3. Drivers will be installed automatically

#### Step 7 – Install GPIO Driver

1. Open the **Step6 - GPIO** folder followed by **SetupSerialIO.exe**
2. Follow the instructions
3. Drivers will be installed automatically



# Appendix A

---

## Watchdog Timer Programming

## A.1 Watchdog Timer Registers

Table 1 : Watch dog relative IO address		
	Default Value	Note
I/O Base Address	0xA10	I/O Base address for Watchdog operation. This address is assigned by SIO LDN7, register 0x60-0x61.

Table 2 : Watchdog relative register table				
Register	Offset	BitNum	Value	Note
Watchdog WDRST# Enable	0x00	7	1	Enable/Disable time out output via WDRST# 0: Disable 1: Enable
Pulse Width	0x05	0:1	01	Width of Pulse signal 00: 1ms (do not use) 01: 25ms 10: 125ms 11: 5s <b>Pulse width is must longer then 16ms.</b>
Signal Polarity	0x05	2	0	0: low active 1: high active <b>Must set this bit to 0</b>
Counting Unit	0x05	3	0	Select time unit. 0: second 1: minute
Output Signal Type	0x05	4	1	0: Level 1: Pulse <b>Must set this bit to 1</b>
Watchdog Timer Enable	0x05	5	1	0: Disable 1: Enable
Timeout Status	0x05	6	1	1: timeout occurred. Write a 1 to clear timeout status
Timer Counter	0x06			Time of watchdog timer (0~255)

## A.2 Watchdog Sample Program

```
*****
// WDT I/O operation relative definition (Please reference to Table 1)
#define WDTAddr 0x510 // WDT I/O base address
Void WDTWriteByte(byte Register, byte Value);
byte WDTReadByte(byte Register);
Void WDTSetReg(byte Register, byte Bit, byte Val);
// Watch Dog relative definition (Please reference to Table 2)
#define DevReg 0x00 // Device configuration register
    #define WDRstBit 0x80 // Watchdog WDTRST# (Bit7)
    #define WDRstVal 0x80 // Enabled WDTRST#
#define TimerReg 0x05 // Timer register
    #define PSWidthBit 0x00 // WDTRST# Pulse width (Bit0:1)
    #define PSWidthVal 0x01 // 25ms for WDTRST# pulse
    #define PolarityBit 0x02 // WDTRST# Signal polarity (Bit2)
    #define PolarityVal 0x00 // Low active for WDTRST#
    #define UnitBit 0x03 // Unit for timer (Bit3)
    #define ModeBit 0x04 // WDTRST# mode (Bit4)
    #define ModeVal 0x01 // 0:level 1: pulse
    #define EnableBit 0x05 // WDT timer enable (Bit5)
    #define EnableVal 0x01 // 1: enable
    #define StatusBit 0x06 // WDT timer status (Bit6)
#define CounterReg 0x06 // Timer counter register
*****

VOID Main(){
    // Procedure : AaeonWDTConfig
    // (byte)Timer : Counter of WDT timer.(0x00~0xFF)
    // (boolean)Unit : Select time unit(0: second, 1: minute).
    AaeonWDTConfig(Counter, Unit);

    // Procedure : AaeonWDTEnable
    // This procedure will enable the WDT counting.
    AaeonWDTEnable();
}
*****

// Procedure : AaeonWDTEnable
```

```

VOID AaeonWDTEnable (){
    WDTEnableDisable(1);
}

// Procedure : AaeonWDTConfig
VOID AaeonWDTConfig (byte Counter, BOOLEAN Unit){
    // Disable WDT counting
    WDTEnableDisable(0);
    // Clear Watchdog Timeout Status
    WDTClearTimeoutStatus();
    // WDT relative parameter setting
    WDTParameterSetting(Timer, Unit);
}

VOID WDTEnableDisable(byte Value){
    If (Value == 1)
        WDTSetBit(TimerReg, EnableBit, 1);
    else
        WDTSetBit(TimerReg, EnableBit, 0);
}

VOID WDTParameterSetting(byte Counter, BOOLEAN Unit){
    // Watchdog Timer counter setting
    WDTWriteByte(CounterReg, Counter);
    // WDT counting unit setting
    WDTSetBit(TimerReg, UnitBit, Unit);
    // WDT output mode set to pulse
    WDTSetBit(TimerReg, ModeBit, ModeVal);
    // WDT output mode set to active low
    WDTSetBit(TimerReg, PolarityBit, PolarityVal);
    // WDT output pulse width is 25ms
    WDTSetBit(TimerReg, PSWidthBit, PSWidthVal);
    // Watchdog WDTRST# Enable
    WDTSetBit(DevReg, WDTRstBit, WDTRstVal);
}

VOID WDTClearTimeoutStatus(){
    WDTSetBit(TimerReg, StatusBit, 1);
}

*****
*****

```

```
VOID  WDTWriteByte(byte Register, byte Value){
    IOWriteByte(WDTAddr+Register, Value);
}

byte  WDTReadByte(byte Register){
    return IOReadByte(WDTAddr+Register);
}

VOID  WDTSetBit(byte Register, byte Bit, byte Val){
    byte TmpValue;

    TmpValue = WDTReadByte(Register);
    TmpValue &= ~(1 << Bit);
    TmpValue |= Val << Bit;
    WDTWriteByte(Register, TmpValue);
}
```

```
*****
```



















# Appendix B

---

I/O Information

## B.1 I/O Address Map

DESKTOP-TGD04TV	
Input/output (IO)	
[0000000000000000 - 000000000000006F]	PCI Express Root Complex
[0000000000000020 - 0000000000000021]	Programmable interrupt controller
[0000000000000024 - 0000000000000025]	Programmable interrupt controller
[0000000000000028 - 0000000000000029]	Programmable interrupt controller
[000000000000002C - 000000000000002D]	Programmable interrupt controller
[000000000000002E - 000000000000002F]	Motherboard resources
[0000000000000030 - 0000000000000031]	Programmable interrupt controller
[0000000000000034 - 0000000000000035]	Programmable interrupt controller
[0000000000000038 - 0000000000000039]	Programmable interrupt controller
[000000000000003C - 000000000000003D]	Programmable interrupt controller
[0000000000000040 - 0000000000000043]	System timer
[000000000000004E - 000000000000004F]	Motherboard resources
[0000000000000050 - 0000000000000053]	System timer
[0000000000000060 - 0000000000000060]	Standard PS/2 Keyboard
[0000000000000061 - 0000000000000061]	Motherboard resources
[0000000000000063 - 0000000000000063]	Motherboard resources
[0000000000000064 - 0000000000000064]	Standard PS/2 Keyboard
[0000000000000065 - 0000000000000065]	Motherboard resources
[0000000000000067 - 0000000000000067]	Motherboard resources
[0000000000000070 - 0000000000000070]	Motherboard resources
[0000000000000070 - 0000000000000077]	System CMOS/real time clock
[0000000000000078 - 000000000000CF7]	PCI Express Root Complex
[0000000000000080 - 000000000000008F]	Motherboard resources
[0000000000000092 - 0000000000000092]	Motherboard resources
[00000000000000A0 - 00000000000000A1]	Programmable interrupt controller
[00000000000000A4 - 00000000000000A5]	Programmable interrupt controller
[00000000000000A8 - 00000000000000A9]	Programmable interrupt controller
[00000000000000AC - 00000000000000AD]	Programmable interrupt controller
[00000000000000B0 - 00000000000000B1]	Programmable interrupt controller
[00000000000000B2 - 00000000000000B3]	Motherboard resources
[00000000000000B4 - 00000000000000B5]	Programmable interrupt controller
[00000000000000B8 - 00000000000000B9]	Programmable interrupt controller
[00000000000000BC - 00000000000000BD]	Programmable interrupt controller

































	[00000000000002E8 - 0000000000002EF]	Communications Port (COM4)
	[0000000000002F8 - 0000000000002FF]	Communications Port (COM2)
	[0000000000003E8 - 0000000000003EF]	Communications Port (COM3)
	[0000000000003F8 - 0000000000003FF]	Communications Port (COM1)
	[000000000000400 - 00000000000047F]	Motherboard resources
	[0000000000004D0 - 0000000000004D1]	Programmable interrupt controller
	[000000000000500 - 0000000000005FE]	Motherboard resources
	[000000000000680 - 00000000000069F]	Motherboard resources
	[000000000000A00 - 000000000000A0F]	Motherboard resources
	[000000000000A10 - 000000000000A1F]	Motherboard resources
	[000000000000A20 - 000000000000A2F]	Motherboard resources
	[000000000000D00 - 000000000000FFF]	PCI Express Root Complex
	[000000000000D000 - 000000000000DFFF]	Intel(R) Celeron(R)/Pentium(R) Processor PCI Express Root Port - 5AD9
	[000000000000E000 - 000000000000EFFF]	Intel(R) Celeron(R)/Pentium(R) Processor PCI Express Root Port - 5AD8
	[000000000000F000 - 000000000000F03F]	Intel(R) HD Graphics
	[000000000000F040 - 000000000000F05F]	Intel(R) Celeron(R)/Pentium(R) Processor SMBUS - 5AD4
	[000000000000F060 - 000000000000F07F]	Standard SATA AHCI Controller
	[000000000000F080 - 000000000000F083]	Standard SATA AHCI Controller
	[000000000000F090 - 000000000000F097]	Standard SATA AHCI Controller





































## B.2 Memory Address Map

Address Range	Device Name
[0000000000A0000 - 0000000000BFFFFF]	PCI Express Root Complex
[0000000000C0000 - 0000000000DFFFFF]	PCI Express Root Complex
[0000000000E0000 - 0000000000FFFFFF]	PCI Express Root Complex
[000000007B800001 - 000000007BFFFFFF]	PCI Express Root Complex
[000000007C000001 - 000000007CFFFFFF]	PCI Express Root Complex
[0000000080000000 - 000000008FFFFFFF]	Intel(R) HD Graphics
[0000000080000000 - 00000000CFFFFFFF]	PCI Express Root Complex
[0000000090000000 - 000000009FFFFFFF]	Intel(R) HD Graphics
[0000000091000000 - 0000000091FFFFFF]	High Definition Audio Controller
[0000000091100000 - 000000009111FFFFF]	Intel(R) I211 Gigabit Network Connection
[0000000091100000 - 000000009111FFFFF]	Intel(R) Celeron(R)/Pentium(R) Processor PCI Express Root Port - 5AD9
[0000000091120000 - 0000000091123FFF]	Intel(R) I211 Gigabit Network Connection
[0000000091200000 - 000000009121FFFFF]	Intel(R) I211 Gigabit Network Connection #2
[0000000091200000 - 000000009122FFFFF]	Intel(R) Celeron(R)/Pentium(R) Processor PCI Express Root Port - 5AD8
[0000000091220000 - 0000000091223FFF]	Intel(R) I211 Gigabit Network Connection #2
[0000000091300000 - 000000009130FFFFF]	Intel(R) USB 3.0 eXtensible Host Controller - 1.0 (Microsoft)
[0000000091310000 - 0000000091313FFF]	High Definition Audio Controller
[0000000091314000 - 0000000091315FFF]	Standard SATA AHCI Controller
[0000000091318000 - 00000000913180FFF]	Intel(R) Celeron(R)/Pentium(R) Processor SMBUS - 5AD4
[0000000091319000 - 00000000913197FFF]	Standard SATA AHCI Controller
[000000009131A000 - 000000009131A0FFF]	Standard SATA AHCI Controller
[000000009131E000 - 000000009131EFFF]	Intel(R) Trusted Execution Engine Interface
[00000000D0C00000 - 00000000D0C00653]	Intel(R) Serial IO GPIO Host Controller - INT3452
[00000000D0C40000 - 00000000D0C40763]	Intel(R) Serial IO GPIO Host Controller - INT3452
[00000000D0C50000 - 00000000D0C5076B]	Intel(R) Serial IO GPIO Host Controller - INT3452
[00000000D0C70000 - 00000000D0C70673]	Intel(R) Serial IO GPIO Host Controller - INT3452
[00000000E0000000 - 00000000EFFFFFFF]	Motherboard resources
[00000000E0000000 - 00000000EFFFFFFF]	PCI Express Root Complex
[00000000FEA00000 - 00000000FEAFFFFFFF]	Motherboard resources
[00000000FED00000 - 00000000FED003FFF]	High precision event timer
[00000000FED01000 - 00000000FED01FFFF]	Motherboard resources
[00000000FED03000 - 00000000FED03FFF]	Motherboard resources
[00000000FED06000 - 00000000FED06FFF]	Motherboard resources
[00000000FED08000 - 00000000FED09FFF]	Motherboard resources
[00000000FED1C000 - 00000000FED1CFFF]	Motherboard resources
[00000000FED40000 - 00000000FED44FFF]	Trusted Platform Module 2.0
[00000000FED80000 - 00000000FEDBFFFF]	Motherboard resources
[00000000FEE00000 - 00000000FEEFFFFFFF]	Motherboard resources



































## B.3 IRQ Mapping Chart

Interrupt request (IRQ)		
	(ISA) 0x00000000 (00)	System timer
	(ISA) 0x00000001 (01)	Standard PS/2 Keyboard
	(ISA) 0x00000003 (03)	Communications Port (COM2)
	(ISA) 0x00000004 (04)	Communications Port (COM1)
	(ISA) 0x00000008 (08)	High precision event timer
	(ISA) 0x0000000A (10)	Communications Port (COM4)
	(ISA) 0x0000000B (11)	Communications Port (COM3)
	(ISA) 0x0000000C (12)	PS/2 Compatible Mouse
	(ISA) 0x0000000E (14)	Intel(R) Serial IO GPIO Host Controller - INT3452
	(ISA) 0x0000000E (14)	Intel(R) Serial IO GPIO Host Controller - INT3452
	(ISA) 0x0000000E (14)	Intel(R) Serial IO GPIO Host Controller - INT3452
	(ISA) 0x0000000E (14)	Intel(R) Serial IO GPIO Host Controller - INT3452
	(ISA) 0x00000036 (54)	Microsoft ACPI-Compliant System
	(ISA) 0x00000037 (55)	Microsoft ACPI-Compliant System
	(ISA) 0x00000038 (56)	Microsoft ACPI-Compliant System
	(ISA) 0x00000039 (57)	Microsoft ACPI-Compliant System
	(ISA) 0x0000003A (58)	Microsoft ACPI-Compliant System
	(ISA) 0x0000003B (59)	Microsoft ACPI-Compliant System
	(ISA) 0x0000003C (60)	Microsoft ACPI-Compliant System
	(ISA) 0x0000003D (61)	Microsoft ACPI-Compliant System
	(ISA) 0x0000003E (62)	Microsoft ACPI-Compliant System
	(ISA) 0x0000003F (63)	Microsoft ACPI-Compliant System
	(ISA) 0x00000040 (64)	Microsoft ACPI-Compliant System
	(ISA) 0x00000041 (65)	Microsoft ACPI-Compliant System
	(ISA) 0x00000042 (66)	Microsoft ACPI-Compliant System
	(ISA) 0x00000043 (67)	Microsoft ACPI-Compliant System
	(ISA) 0x00000044 (68)	Microsoft ACPI-Compliant System
	(ISA) 0x00000045 (69)	Microsoft ACPI-Compliant System
	(ISA) 0x00000046 (70)	Microsoft ACPI-Compliant System
	(ISA) 0x00000047 (71)	Microsoft ACPI-Compliant System
	(ISA) 0x00000048 (72)	Microsoft ACPI-Compliant System
	(ISA) 0x00000049 (73)	Microsoft ACPI-Compliant System
	(ISA) 0x0000004A (74)	Microsoft ACPI-Compliant System



































---

































	(ISA) 0x0000004A (74)	Microsoft ACPI-Compliant System
	(ISA) 0x0000004B (75)	Microsoft ACPI-Compliant System
	(ISA) 0x0000004C (76)	Microsoft ACPI-Compliant System
	(ISA) 0x0000004D (77)	Microsoft ACPI-Compliant System
	(ISA) 0x0000004E (78)	Microsoft ACPI-Compliant System
	(ISA) 0x0000004F (79)	Microsoft ACPI-Compliant System
	(ISA) 0x00000050 (80)	Microsoft ACPI-Compliant System
	(ISA) 0x00000051 (81)	Microsoft ACPI-Compliant System
	(ISA) 0x00000052 (82)	Microsoft ACPI-Compliant System
	(ISA) 0x00000053 (83)	Microsoft ACPI-Compliant System
	(ISA) 0x00000054 (84)	Microsoft ACPI-Compliant System
	(ISA) 0x00000055 (85)	Microsoft ACPI-Compliant System
	(ISA) 0x00000056 (86)	Microsoft ACPI-Compliant System
	(ISA) 0x00000057 (87)	Microsoft ACPI-Compliant System
	(ISA) 0x00000058 (88)	Microsoft ACPI-Compliant System
	(ISA) 0x00000059 (89)	Microsoft ACPI-Compliant System
	(ISA) 0x0000005A (90)	Microsoft ACPI-Compliant System
	(ISA) 0x0000005B (91)	Microsoft ACPI-Compliant System
	(ISA) 0x0000005C (92)	Microsoft ACPI-Compliant System
	(ISA) 0x0000005D (93)	Microsoft ACPI-Compliant System
	(ISA) 0x0000005E (94)	Microsoft ACPI-Compliant System
	(ISA) 0x0000005F (95)	Microsoft ACPI-Compliant System
	(ISA) 0x00000060 (96)	Microsoft ACPI-Compliant System
	(ISA) 0x00000061 (97)	Microsoft ACPI-Compliant System
	(ISA) 0x00000062 (98)	Microsoft ACPI-Compliant System
	(ISA) 0x00000063 (99)	Microsoft ACPI-Compliant System
	(ISA) 0x00000064 (100)	Microsoft ACPI-Compliant System
	(ISA) 0x00000065 (101)	Microsoft ACPI-Compliant System
	(ISA) 0x00000066 (102)	Microsoft ACPI-Compliant System
	(ISA) 0x00000067 (103)	Microsoft ACPI-Compliant System
	(ISA) 0x00000068 (104)	Microsoft ACPI-Compliant System
	(ISA) 0x00000069 (105)	Microsoft ACPI-Compliant System
	(ISA) 0x0000006A (106)	Microsoft ACPI-Compliant System
	(ISA) 0x0000006B (107)	Microsoft ACPI-Compliant System

---

	(ISA) 0x0000004A (74)	Microsoft ACPI-Compliant System
	(ISA) 0x0000004B (75)	Microsoft ACPI-Compliant System
	(ISA) 0x0000004C (76)	Microsoft ACPI-Compliant System
	(ISA) 0x0000004D (77)	Microsoft ACPI-Compliant System
	(ISA) 0x0000004E (78)	Microsoft ACPI-Compliant System
	(ISA) 0x0000004F (79)	Microsoft ACPI-Compliant System
	(ISA) 0x00000050 (80)	Microsoft ACPI-Compliant System
	(ISA) 0x00000051 (81)	Microsoft ACPI-Compliant System
	(ISA) 0x00000052 (82)	Microsoft ACPI-Compliant System
	(ISA) 0x00000053 (83)	Microsoft ACPI-Compliant System
	(ISA) 0x00000054 (84)	Microsoft ACPI-Compliant System
	(ISA) 0x00000055 (85)	Microsoft ACPI-Compliant System
	(ISA) 0x00000056 (86)	Microsoft ACPI-Compliant System
	(ISA) 0x00000057 (87)	Microsoft ACPI-Compliant System
	(ISA) 0x00000058 (88)	Microsoft ACPI-Compliant System
	(ISA) 0x00000059 (89)	Microsoft ACPI-Compliant System
	(ISA) 0x0000005A (90)	Microsoft ACPI-Compliant System
	(ISA) 0x0000005B (91)	Microsoft ACPI-Compliant System
	(ISA) 0x0000005C (92)	Microsoft ACPI-Compliant System
	(ISA) 0x0000005D (93)	Microsoft ACPI-Compliant System
	(ISA) 0x0000005E (94)	Microsoft ACPI-Compliant System
	(ISA) 0x0000005F (95)	Microsoft ACPI-Compliant System
	(ISA) 0x00000060 (96)	Microsoft ACPI-Compliant System
	(ISA) 0x00000061 (97)	Microsoft ACPI-Compliant System
	(ISA) 0x00000062 (98)	Microsoft ACPI-Compliant System
	(ISA) 0x00000063 (99)	Microsoft ACPI-Compliant System
	(ISA) 0x00000064 (100)	Microsoft ACPI-Compliant System
	(ISA) 0x00000065 (101)	Microsoft ACPI-Compliant System
	(ISA) 0x00000066 (102)	Microsoft ACPI-Compliant System
	(ISA) 0x00000067 (103)	Microsoft ACPI-Compliant System
	(ISA) 0x00000068 (104)	Microsoft ACPI-Compliant System
	(ISA) 0x00000069 (105)	Microsoft ACPI-Compliant System
	(ISA) 0x0000006A (106)	Microsoft ACPI-Compliant System
	(ISA) 0x0000006B (107)	Microsoft ACPI-Compliant System

---

	(ISA) 0x00000069 (105)	Microsoft ACPI-Compliant System
	(ISA) 0x0000006A (106)	Microsoft ACPI-Compliant System
	(ISA) 0x0000006B (107)	Microsoft ACPI-Compliant System
	(ISA) 0x0000006C (108)	Microsoft ACPI-Compliant System
	(ISA) 0x0000006D (109)	Microsoft ACPI-Compliant System
	(ISA) 0x0000006E (110)	Microsoft ACPI-Compliant System
	(ISA) 0x0000006F (111)	Microsoft ACPI-Compliant System
	(ISA) 0x00000070 (112)	Microsoft ACPI-Compliant System
	(ISA) 0x00000071 (113)	Microsoft ACPI-Compliant System
	(ISA) 0x00000072 (114)	Microsoft ACPI-Compliant System
	(ISA) 0x00000073 (115)	Microsoft ACPI-Compliant System
	(ISA) 0x00000074 (116)	Microsoft ACPI-Compliant System
	(ISA) 0x00000075 (117)	Microsoft ACPI-Compliant System
	(ISA) 0x00000076 (118)	Microsoft ACPI-Compliant System
	(ISA) 0x00000077 (119)	Microsoft ACPI-Compliant System
	(ISA) 0x00000078 (120)	Microsoft ACPI-Compliant System
	(ISA) 0x00000079 (121)	Microsoft ACPI-Compliant System
	(ISA) 0x0000007A (122)	Microsoft ACPI-Compliant System
	(ISA) 0x0000007B (123)	Microsoft ACPI-Compliant System
	(ISA) 0x0000007C (124)	Microsoft ACPI-Compliant System
	(ISA) 0x0000007D (125)	Microsoft ACPI-Compliant System
	(ISA) 0x0000007E (126)	Microsoft ACPI-Compliant System
	(ISA) 0x0000007F (127)	Microsoft ACPI-Compliant System
	(ISA) 0x00000080 (128)	Microsoft ACPI-Compliant System
	(ISA) 0x00000081 (129)	Microsoft ACPI-Compliant System
	(ISA) 0x00000082 (130)	Microsoft ACPI-Compliant System
	(ISA) 0x00000083 (131)	Microsoft ACPI-Compliant System
	(ISA) 0x00000084 (132)	Microsoft ACPI-Compliant System
	(ISA) 0x00000085 (133)	Microsoft ACPI-Compliant System
	(ISA) 0x00000086 (134)	Microsoft ACPI-Compliant System
	(ISA) 0x00000087 (135)	Microsoft ACPI-Compliant System
	(ISA) 0x00000088 (136)	Microsoft ACPI-Compliant System
	(ISA) 0x00000089 (137)	Microsoft ACPI-Compliant System
	(ISA) 0x0000008A (138)	Microsoft ACPI-Compliant System

	(ISA) 0x000001F2 (498)	Microsoft ACPI-Compliant System
	(ISA) 0x000001F3 (499)	Microsoft ACPI-Compliant System
	(ISA) 0x000001F4 (500)	Microsoft ACPI-Compliant System
	(ISA) 0x000001F5 (501)	Microsoft ACPI-Compliant System
	(ISA) 0x000001F6 (502)	Microsoft ACPI-Compliant System
	(ISA) 0x000001F7 (503)	Microsoft ACPI-Compliant System
	(ISA) 0x000001F8 (504)	Microsoft ACPI-Compliant System
	(ISA) 0x000001F9 (505)	Microsoft ACPI-Compliant System
	(ISA) 0x000001FA (506)	Microsoft ACPI-Compliant System
	(ISA) 0x000001FB (507)	Microsoft ACPI-Compliant System
	(ISA) 0x000001FC (508)	Microsoft ACPI-Compliant System
	(ISA) 0x000001FD (509)	Microsoft ACPI-Compliant System
	(ISA) 0x000001FE (510)	Microsoft ACPI-Compliant System
	(ISA) 0x000001FF (511)	Microsoft ACPI-Compliant System
	(PCI) 0x00000019 (25)	High Definition Audio Controller
	(PCI) 0xFFFFFED (-19)	Intel(R) USB 3.0 eXtensible Host Controller - 1.0 (Microsoft)
	(PCI) 0xFFFFFEE (-18)	Intel(R) I211 Gigabit Network Connection
	(PCI) 0xFFFFFEF (-17)	Intel(R) I211 Gigabit Network Connection
	(PCI) 0xFFFFFFF0 (-16)	Intel(R) I211 Gigabit Network Connection
	(PCI) 0xFFFFFFF1 (-15)	Intel(R) I211 Gigabit Network Connection
	(PCI) 0xFFFFFFF2 (-14)	Intel(R) I211 Gigabit Network Connection
	(PCI) 0xFFFFFFF3 (-13)	Intel(R) I211 Gigabit Network Connection
	(PCI) 0xFFFFFFF4 (-12)	Intel(R) I211 Gigabit Network Connection #2
	(PCI) 0xFFFFFFF5 (-11)	Intel(R) I211 Gigabit Network Connection #2
	(PCI) 0xFFFFFFF6 (-10)	Intel(R) I211 Gigabit Network Connection #2
	(PCI) 0xFFFFFFF7 (-9)	Intel(R) I211 Gigabit Network Connection #2
	(PCI) 0xFFFFFFF8 (-8)	Intel(R) I211 Gigabit Network Connection #2
	(PCI) 0xFFFFFFF9 (-7)	Intel(R) I211 Gigabit Network Connection #2
	(PCI) 0xFFFFFFFA (-6)	Intel(R) Trusted Execution Engine Interface
	(PCI) 0xFFFFFFFB (-5)	Intel(R) HD Graphics
	(PCI) 0xFFFFFFF4 (-4)	Standard SATA AHCI Controller
	(PCI) 0xFFFFFFF3 (-3)	Intel(R) Celeron(R)/Pentium(R) Processor PCI Express Root Port - 5AD9
	(PCI) 0xFFFFFFF2 (-2)	Intel(R) Celeron(R)/Pentium(R) Processor PCI Express Root Port - 5AD8

# Appendix C

---

Mating Connectors

## C.1 List of Mating Connectors and Cables

The table notes mating connectors and available cables.

Connector Label	Function	Mating Connector		Available Cable	Cable P/N
		Vendor	Model no		
CN1	External AUX Power and PS_ON#	JST	PHR-6	N/A	N/A
CN2	LVDS Port1 Inverter Connector	JST	PHR-5	N/A	N/A
CN3	+5Vout Connector	JST	PHR-2	2 Pins For SATA HDD Power	1702150155
CN4	SATA Connector	Molex	887505318	SATA Cable	1709070500
CN5	Power Input Connector	Molex	19211-0003	Power Cable	170204010R
CN6	External +5VSB Power Input and PS_ON#	JST	XHP-3	ATX Cable	170220020B
CN7	Audio Connector	Molex	51021-1000	Audio Cable	1709100254
CN8	LVDS Port1	HIROSE	DF13-30DS-1.25C	N/A	N/A



	Connector				
CN9	COM Port #2 Connector	Molex	51021-0900	Serial Port Cable	1701090150
CN10	LPT or Digital I/O Connector	Molex	51110-2650	Parallel Port Cable	1701260200
CN11	LPC Connector	JST	SHR-12V-S-B	AAEON LPC Cable	1703120130
CN12	COM Port #3 Connector	Molex	51021-0900	Serial Port Cable	1701090150
CN14	COM Port #4 Connector	Molex	51021-0900	Serial Port Cable	1701090150
CN15	PS/2 KB/MS Connector	JST	PHDR-06VS	PS/2 KB/MS Cable	1700060152
CN16	USB Port #2 Connector	Molex	51021-0500	USB Cable	1700050207
CN17	USB Port #3 Connector	Molex	51021-0500	USB Cable	1700050207
CN19	USB Port #4 Connector	Molex	51021-0500	USB Cable	1700050207
CN20	USB Port	Molex	51021-0500	USB Cable	1700050207

	#5 Connector				
CN21	LVDS Port2 Connector	HIROSE	DF13-30DS-1.25C	N/A	N/A
CN22	Touch Screen Connector	JST	SHR-9V-S-B	N/A	N/A
CN23	CPU Fan Connector	Molex	22-01-2035	N/A	N/A
CN24	LVDS Port1 Inverter Connector	JST	PHR-5	N/A	N/A
CN30	External RTC Connector	Molex	51021-0200	Battery Cable	175011301C

# Appendix D

---

Electrical Specifications for I/O Ports

## D.1 Electrical Specifications for I/O Ports

Connector Label	Signal name	Rate output	I/O
CN2	+5V/+12V	+5V/1.5A or +12V/1.5A	LVDS Port1 Inverter / Backlight Connector
CN3	+5V	+5V/1A	+5V Output for SATA HDD
CN8	+3.3V/+5V	+3.3V/2A or +5V/2A	LVDS Port1
CN9	+5V/+12V	+5V/1A or +12V/1A	COM Port 2
CN10	+5V	+5V/1A	Digital IO Port
CN12	+5V/+12V	+5V/1A or +12V/1A	COM Port 3
CN16	+5VSB	+5V/0.5A	USB 2.0 Ports 2
CN17	+5VSB	+5V/0.5A	USB 2.0 Ports 3
CN19	+5VSB	+5V/0.5A	USB 2.0 Ports 4
CN20	+5VSB	+5V/0.5A	USB 2.0 Ports 5
CN21	+3.3V/+5V	+3.3V/2A or +5V/2A	LVDS Port2
CN23	+12V	+12V/0.5A	CPU FAN
CN24	+5V/+12V	+5V/1.5A or +12V/1.5A	LVDS Port2 Inverter / Backlight Connector
CN25	+5VSB	+5V/1A (per channel)	USB Ports 0 and 1
CN34	+3.3V	+3.3V/1A	mSATA (Full-Mini Card)
CN33	+3.3VSB +1.5V	+3.3V/1.1A +1.5V/0.375A	Mini-Card Slot (Half-Mini Card)

# Appendix E

---

Digital I/O Ports

## E.1 Digital I/O Register

### 7.1.2 Logic Device Number Register (LDN) — Index 07h

Bit	Name	R/W	Reset	Default	Description
7-0	LDN	R/W	LRESET#	00h	00h: Select FDC device configuration registers. 03h: Select Parallel Port device configuration registers. 04h: Select Hardware Monitor device configuration registers. 05h: Select KBC device configuration registers. 06h: Select GPIO device configuration registers. 07h: Select WDT device configuration registers. 0Ah: Select PME, ACPI and ERP device configuration registers. 10h: Select UART1 device configuration registers. 11h: Select UART2 device configuration registers. 12h: Select UART3 device configuration registers. 13h: Select UART4 device configuration registers. 14h: Select UART5 device configuration registers. 15h: Select UART6 device configuration registers. Otherwise: Reserved.

### GPIO8 Output Enable Register — Index 88h

Bit	Name	R/W	Reset	Default	Description
7	GPIO87_OE	R/W	LRESET#	0	0: GPIO87 is in input mode. 1: GPIO87 is in output mode.
6	GPIO86_OE	R/W	LRESET#	0	0: GPIO86 is in input mode. 1: GPIO85 is in output mode.
5	GPIO85_OE	R/W	LRESET#	0	0: GPIO85 is in input mode. 1: GPIO85 is in output mode.
4	GPIO84_OE	R/W	LRESET#	0	0: GPIO84 is in input mode. 1: GPIO84 is in output mode.
3	GPIO83_OE	R/W	LRESET#	0	0: GPIO83 is in input mode. 1: GPIO83 is in output mode.
2	GPIO82_OE	R/W	LRESET#	0	0: GPIO82 is in input mode. 1: GPIO82 is in output mode.
1	GPIO81_OE	R/W	LRESET#	0	0: GPIO81 is in input mode. 1: GPIO81 is in output mode.
0	GPIO80_OE	R/W	LRESET#	0	0: GPIO80 is in input mode. 1: GPIO80 is in output mode.

**GPIO8 Output Data Register — Index 89h (This byte could be also written by base address + 2)**

Bit	Name	R/W	Reset	Default	Description
7	GPIO87_VAL	R/W	LRESET#	1	0: GPIO87 outputs 0 when in output mode. 1: GPIO87 outputs 1 when in output mode.
6	GPIO86_VAL	R/W	LRESET#	1	0: GPIO86 outputs 0 when in output mode. 1: GPIO86 outputs 1 when in output mode.
5	GPIO85_VAL	R/W	LRESET#	1	0: GPIO85 outputs 0 when in output mode. 1: GPIO85 outputs 1 when in output mode.
4	GPIO84_VAL	R/W	LRESET#	1	0: GPIO84 outputs 0 when in output mode. 1: GPIO84 outputs 1 when in output mode.
3	GPIO83_VAL	R/W	LRESET#	1	0: GPIO83 outputs 0 when in output mode. 1: GPIO83 outputs 1 when in output mode.
2	GPIO82_VAL	R/W	LRESET#	1	0: GPIO82 outputs 0 when in output mode. 1: GPIO82 outputs 1 when in output mode.
1	GPIO81_VAL	R/W	LRESET#	1	0: GPIO81 outputs 0 when in output mode. 1: GPIO81 outputs 1 when in output mode.
0	GPIO80_VAL	R/W	LRESET#	1	0: GPIO80 outputs 0 when in output mode. 1: GPIO80 outputs 1 when in output mode.

**GPIO8 Pin Status Register — Index 8Ah (This byte could be also read by base address + 2)**

Bit	Name	R/W	Reset	Default	Description
7	GPIO87_IN	R	-	-	The pin status of GPIO87/PD7.
6	GPIO86_IN	R	-	-	The pin status of GPIO86/PD6.
5	GPIO85_IN	R	-	-	The pin status of GPIO85/PD5.
4	GPIO84_IN	R	-	-	The pin status of GPIO84/PD4.
3	GPIO83_IN	R	-	-	The pin status of GPIO83/PD3.
2	GPIO82_IN	R	-	-	The pin status of GPIO82/PD2.
1	GPIO81_IN	R	-	-	The pin status of GPIO81/PD1.
0	GPIO80_IN	R	-	-	The pin status of GPIO80/PD0.

## E.2 Digital I/O Sample Code (4 in 4 out, 2 low 2 high)

---

```
Outputb(0x2E,0x87); //enter configuration
Outputb(0x2E,0x87);

Outputb(0x2E,0x07); //set LDN
Outputb(0x2F,0x06);

Outputb(0x2E,0xA0); //GPIO set 5 register
Outputb(0x2F,0xF0);

Outputb(0x2E,0xA1); //GPIO output data register
Outputb(0x2F,0x30);

Outputb(0x2E,0xAA); //exit configuration
```