

**GENE-5315**

AMD® Geode

LX800/900 series Processors

RTL8139DL for 10/100Mbps

Type II CompactFlash

2 COM (Rev.A), 5 COM (Rev.B)

4 USB2.0, 1 IrDA

Type III Mini PCI

## Copyright Notice

This document is copyrighted, 2009. All rights are reserved. The original manufacturer reserves the right to make improvements to the products described in this manual at any time without notice.

No part of this manual may be reproduced, copied, translated, or transmitted in any form or by any means without the prior written permission of the original manufacturer. Information provided in this manual is intended to be accurate and reliable. However, the original manufacturer assumes no responsibility for its use, or for any infringements upon the rights of third parties that may result from its use.

The material in this document is for product information only and is subject to change without notice. While reasonable efforts have been made in the preparation of this document to assure its accuracy, AAEON assumes no liabilities resulting from errors or omissions in this document, or from the use of the information contained herein.

AAEON reserves the right to make changes in the product design without notice to its users.

## Acknowledgments

All other products' name or trademarks are properties of their respective owners.

- Award is a trademark of Award Software International, Inc.
- CompactFlash™ is a trademark of the Compact Flash Association.
- AMD, the AMD Arrow logo and combinations thereof are trademarks of Advanced Micro Devices, Inc.
- Microsoft Windows® is a registered trademark of Microsoft Corp.
- ITE is a trademark of Integrated Technology Express, Inc.
- IBM, PC/AT, PS/2, and VGA are trademarks of International Business Machines Corporation.
- SoundBlaster is a trademark of Creative Labs, Inc.

All other product names or trademarks are properties of their respective owners.

## Packing List

Before you begin installing your card, please make sure that the following materials have been shipped:

- 1 9681531501 Cable Kit for GENE-5315
  - 1700060192 Keyboard & Mouse Cable
  - 1709100201 USB Cable
  - 1701440500 IDE Cable 3.5"
- 1 9657666600 Jumper Cap
- 1 Quick Installation Guide
- 1 CD-ROM for manual (in PDF format) and drivers
- 1 GENE-5315

If any of these items should be missing or damaged, please contact your distributor or sales representative immediately.

# Contents

## Chapter 1 General Information

1.1 Introduction.....	1-2
1.2 Features .....	1-3
1.3 Specifications .....	1-4

## Chapter 2 Quick Installation Guide

2.1 Safety Precautions .....	2-2
2.2 Connectors, Jumpers and Mechanical Drawings.....	2-3
2.3 List of Jumpers .....	2-9
2.4 List of Connectors .....	2-10
2.5 Setting Jumpers .....	2-12
2.6 AT/ATX Power Type Selection (JP1) .....	2-13
2.7 CFD Master/ Slave Selection (JP2) .....	2-13
2.8 Clear CMOS (JP3) .....	2-13
2.9 LCD Clock and LVDS Operating Voltage Selection (JP4) .....	2-13
2.10 COM Ports RI/+5V/+12V Selection (JP5) .....	2-14
2.11 Inverter Voltage Connector (JP6).....	2-14
2.12 CFD Voltage Selection (JP7) (For Rev.B only).....	2-14
2.13 IDE Hard Drive Connector (CN1).....	2-14
2.14 Floppy Connector (CN2) .....	2-15
2.15 Parallel Port Connector (CN3) .....	2-16
2.16 Front Panel Connector (CN4) .....	2-17

2.17 USB Port #1 and Port #2 (CN5).....	2-17
2.18 Digital I/O Connector (CN6) .....	2-17
2.19 Audio Input/Output/Cdin/MIC (CN7).....	2-18
2.20 ATX External 5VSB (CN8) .....	2-18
2.21 4P Power Socket (CN9) .....	2-19
2.22 LVDS Connector (CN10).....	2-19
2.23 PC/104 (CN11) (For Rev.A only) .....	2-20
2.24 TTL LCD (CN12) .....	2-22
2.25 Serial Port #2 (CN13) .....	2-24
2.26 Fan Connector (CN14) .....	2-24
2.27 Ethernet 10/100Base-TX RJ-45 Phone Jack #1 (CN15) .....	2-25
2.28 Ethernet 10/100Base-TX RJ-45 Phone Jack #2 (CN16) .....	2-25
2.29 IrDA Connector (CN17).....	2-25
2.30 Mini-DIN PS/2 Keyboard/Mouse Connector (CN18)	2-26
2.31 Serial Port #1 Connector (CN19) .....	2-26
2.32 CRT Display Connector (CN20).....	2-26
2.33 USB Port #3 and Port #4 (CN21) .....	2-27
2.34 Inverter Voltage (CN22) .....	2-27
2.35 Serial Port #3 (CN23)(For Rev.B only).....	2-27
2.36 Serial Port #5 (CN24)(For Rev.B only).....	2-28
2.37 Serial Port #4 (CN25)(For Rev.B only).....	2-28
2.38 Serial Port #6 (CN26) (TTL/GPS) (For Rev.B only)	2-28
2.39 External Battery (BAT1) .....	2-29

2.40 Compact Flash Disk Slot (CFD1) .....	2-29
2.41 Mini-PCI Slot (MPC11) .....	2-30
2.42 DDR SODIMM Slot (DIMM1) .....	2-30

### **Chapter 3 Award BIOS Setup**

3.1 System Test and Initialization. ....	3-2
3.2 Award BIOS Setup .....	3-3

### **Chapter 4 Driver Installation**

4.1 Software Drivers.....	4-2
4.2 Necessary to know.....	4-3
4.3 Installing VGA Driver.....	4-4
4.4 Installing AES Driver .....	4-5
4.5 Installing PCI to ISA Bridge Driver .....	4-6
4.6 Installing Ethernet Driver.....	4-7
4.7 Ethernet Software Configuration.....	4-7
4.8 Installing Audio Driver .....	4-8

### **Appendix A Programming The Watchdog Timer**

A.1 Programming .....	A-2
A.2 ITE8712 Watchdog Timer Initial Program.....	A-5

### **Appendix B I/O Information**

B.1 I/O Address Map.....	B-2
B.2 1 <sup>st</sup> MB Memory Address Map .....	B-2
B.3 IRQ Mapping Chart for Rev. A.....	B-3
B.4 IRQ Mapping Chart for Rev. B.....	B-3

B.5 DMA Channel Assignments.....B-3

**Appendix C Mating Connector**

C.1 List of Mating Connectors and Cables..... C-2



Chapter

1

**General  
Information**

## 1.1 Introduction

---

AAEON, a leading embedded boards manufacturer, is pleased to announce the debut of their new generation 3.5" SubCompact Board—GENE-5315. The GENE-5315 not only completes AAEON's product line of Subcompact boards, but also balances performance and cost in the embedded market.

GENE-5315 adopts optional onboard AMD Geode LX800 and LX900. The system memory is deployed with SODIMM DDR 333/400 up to 1GB. In addition, Realtek RTL8139DL supports two 10/100Base-TX that allows network connections. This model applies a Type III Mini PCI socket for expansion. Moreover, four USB 2.0, IDE, RS-232, RS-232/422/485 and parallel ports are configured on the GENE-5315. Full functions make GENE-5315 user friendly. With the GENE-5315, there are no more worries about installing many necessary devices to complete the functions of your system.

The display of GENE-5315 supports CRT/LCD simultaneous display and is up to 24-bit single channel TTL/LVDS TFT LCD. These great features fit into the needs of digital signage. Furthermore, this brand new SubCompact board is developed to cater to the requirements of Automation, Medical, ticket machine, transportation, gaming, KIOSK, and POS/POI applications.

## 1.2 Features

---

- Onboard AMD Geode LX 800/LX900 processors
- SODIMM DDR 333 Max. 1GB, DDR 400 Max. 512MB
- Up to 24-bit Single Channel LVDS TFT LCD
- Dual 10/100Mbps Ethernet
- Type III Mini-PCI and PC/104 (For Rev.A Only) Expansions
- IDE, Floppy Disk Drive & Compactflash Slot
- AC97 Codec 2 CH Audio
- COM, Parallel x 1, USB2.0 x 4, 8-bit Digital I/O, IrDA
- +5V Only Operation

## 1.3 Specifications

---

### System

- Processor Onboard AMD Geode LX800/ LX900 Series Processor
- System Memory 200-pin DDR SODIMM x 1, Max. 1GB for DDR333 and 512MB for DDR 400
- Chipset AMD LX series + CS5536
- I/O Chipset ITE IT8712+ IT8888G
- Ethernet Realtek RTL8139DL, 10/100Mbps, RJ-45 x 2
- BIOS Award Plug & Play BIOS – 1MB ROM
- Watchdog Timer Generates a time-out system reset
- H/W Monitor Chipset Supports power supply voltages and temperature monitoring
- Expansion Interface PC/104 x 1 (For Rev.A only), Mini PCI x 1
- Power Requirement +5V/AT/ATX
- Board Size 5.75”(L) x 4”(W) (146mm x 101.6mm)
- Operating Temperature 32°F~ 140°F (0°C ~ 60°C)  
-4°F~ 158°F (-20°C~70°C) (for GENE-5315W1 only)

**Display Supports CRT/LCD simultaneous display**

- Chipset AMD LX series + TI SN75LVDS83
- Memory Shared system memory up to 254 MB
- LCD Interface Up to 24-bit TTL/LVDS TFT LCD
- Resolution Up to 1920 x 1440 @ 24bpp for CRT  
Up to 1600 x 1200 @ 24bpp for LCD

**I/O**

- Storage EIDE x 1 (UDMA-33 x 1); Floppy Disk Drive x 1; Type II CompactFlash x 1
- Serial Port RS-232 x 1 (Rev.A)/ RS-232 x 4 & TTL UART x 1 (Rev.B), RS-232/422/485 x 1
- Parallel Port SPP/EPP/ECP mode
- USB Port USB2.0 x 4
- PS/2 Port Keyboard & Mouse x 1
- Digital I/O Supports 8-bit (Programmable)
- IrDA One IrDA Tx/Rx header
- Audio Realtek ALC203 2CH AC97 Codec, MIC-in/ Line-in/ Line-out/ CD-in

## Chapter

# 2

## Quick Installation Guide

**Notice:**

*The Quick Installation Guide is derived from Chapter 2 of user manual. For other chapters and further installation instructions, please refer to the user manual CD-ROM that came with the product.*



## 2.1 Safety Precautions

---

**Warning!**

*Always completely disconnect the power cord from your board whenever you are working on it. Do not make connections while the power is on, because a sudden rush of power can damage sensitive electronic components.*

**Caution!**

*Always ground yourself to remove any static charge before touching the board. Modern electronic devices are very sensitive to static electric charges. Use a grounding wrist strap at all times. Place all electronic components on a static-dissipative surface or in a static-shielded bag when they are not in the chassis*

## 2.2 Jumpers, Connectors, and Mechanical Drawings

GENE-5315 Rev.A

### Component Side

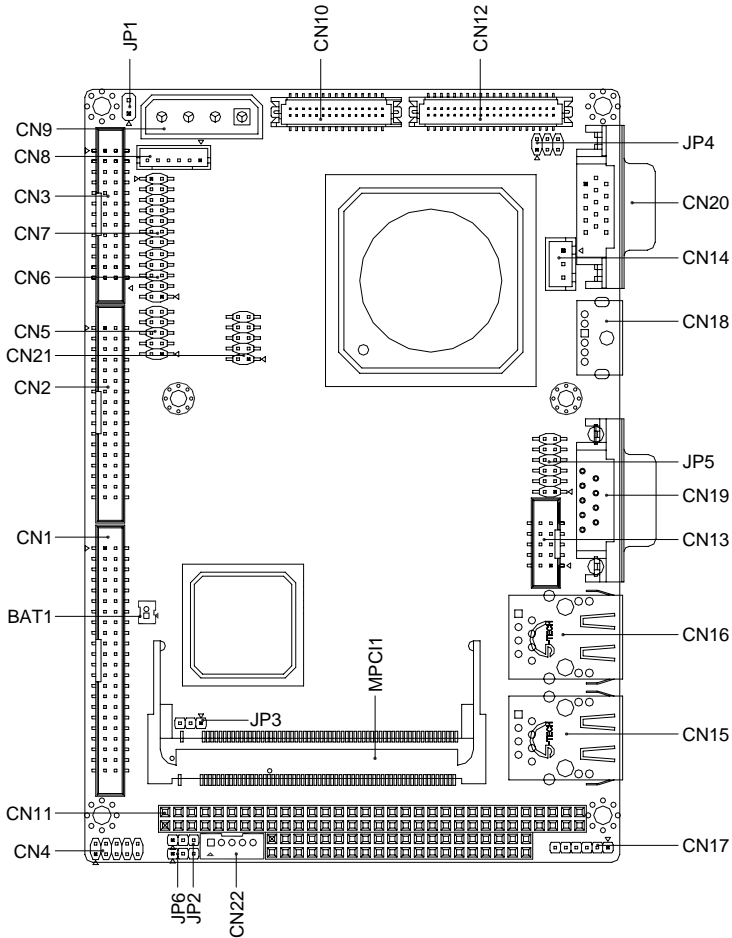



Solder Side

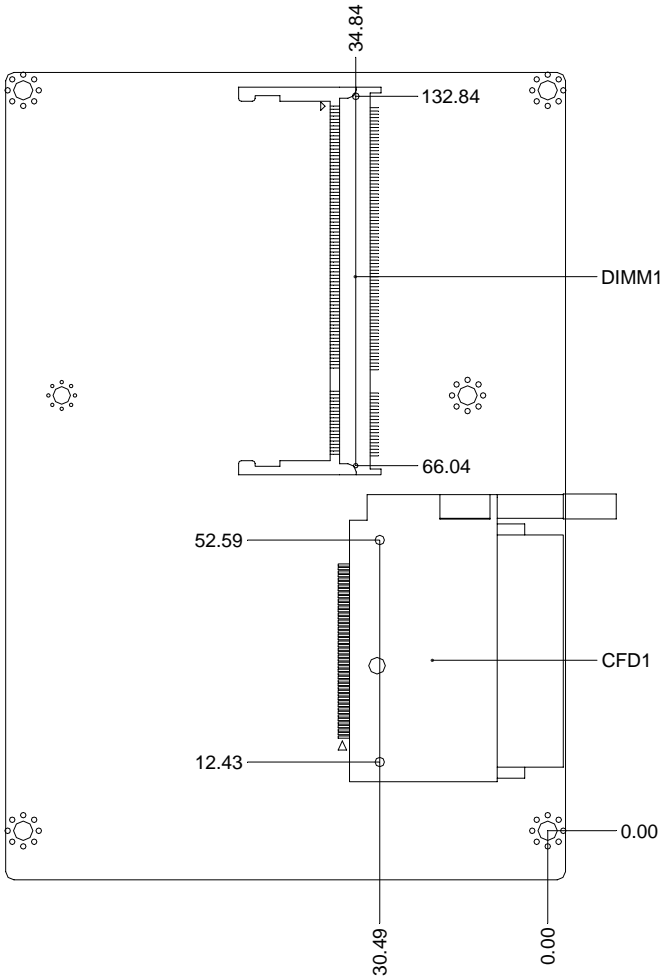

Mechanical Drawings

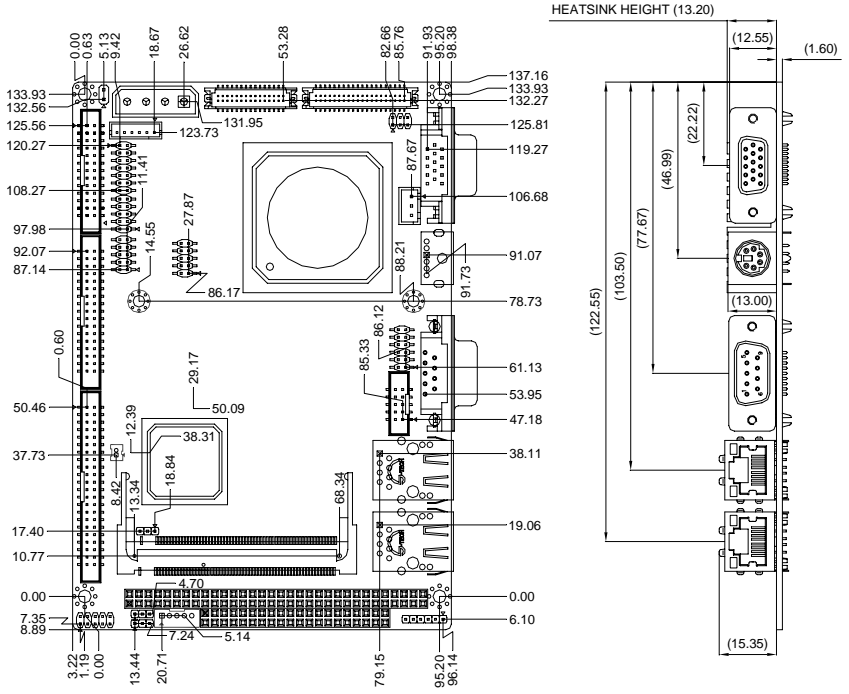

GENE-5315 Rev.B

Component Side

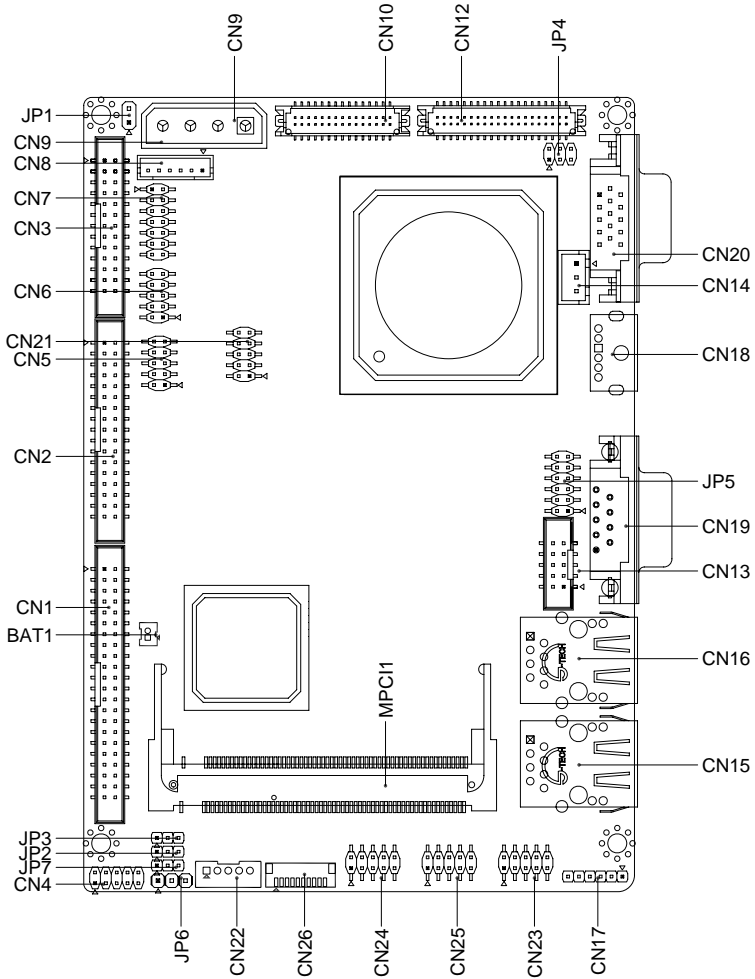

Solder Side

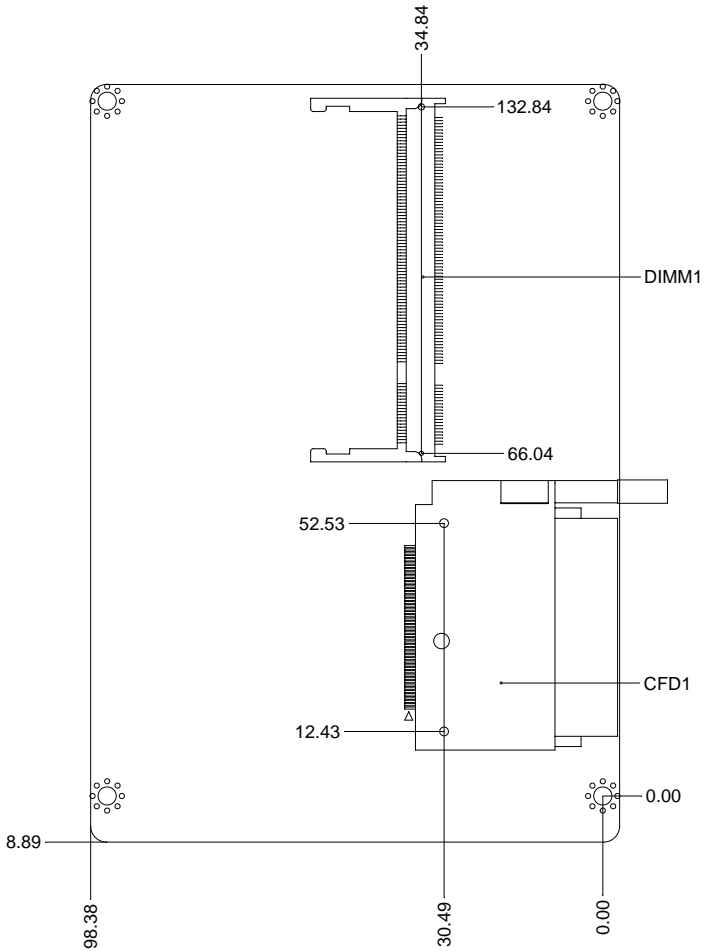

Mechanical Drawings

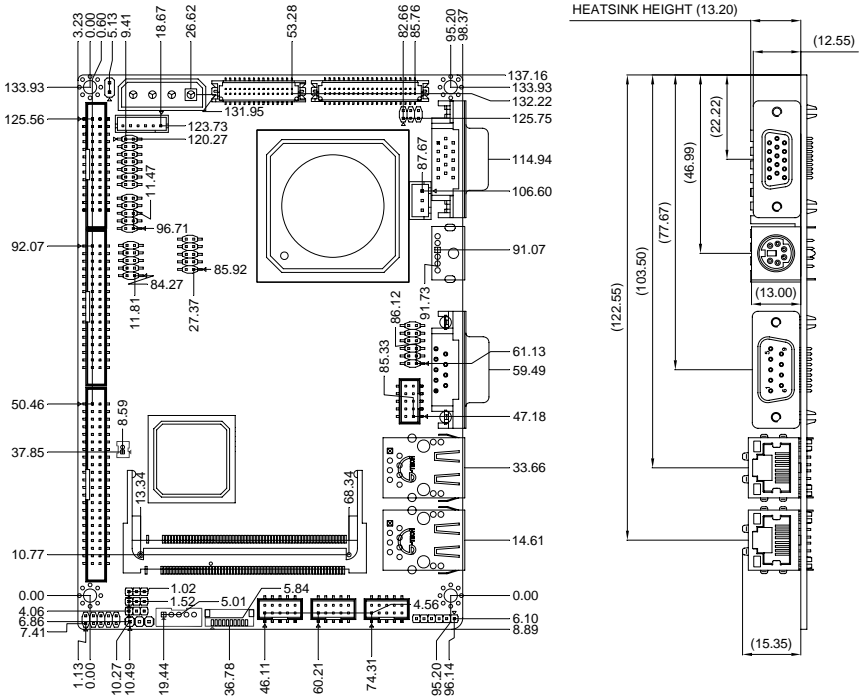

## 2.3 List of Jumpers

---

The board has a number of jumpers that allow you to configure your system to suit your application.

The table below shows the function of each of the board's jumpers:

<b>Label</b>	<b>Function</b>
JP1	AT/ATX Power Type Selection
JP2	CFD Master/Slave Selection
JP3	Clear CMOS
JP4	LCD Clock and LVDS Operating Voltage Selection
JP5	COM Ports RI/+5V/+12V Selection
JP6	Inverter Voltage Selection
JP7	CFD Voltage Selection (For Rev. B only)

## 2.4 List of Connectors

---

The board has a number of connectors that allow you to configure your system to suit your application.

The table below shows the function of each of the board's connectors:

**Note:** For further information about mating connectors, please refer to the appendix of the manual.

Label	Function
CN1	IDE Hard Drive
CN2	Floppy
CN3	Parallel Port
CN4	Front Panel
CN5	USB Port #1 and Port #2
CN6	Digital I/O
CN7	Audio Input/Output/CD-in/MIC
CN8	ATX External 5VSB
CN9	4P Power Socket
CN10	LVDS LCD
CN11	PC/104 (For Rev. A only)
CN12	TTL LCD
CN13	Serial Port #2
CN14	System FAN
CN15	Ethernet 10/100 Base-TX RJ-45 Phone Jack #1
CN16	Ethernet 10/100 Base-TX RJ-45 Phone Jack #2
CN17	IrDA

---

CN18	Mini-Din PS/2
CN19	Serial Port #1
CN20	CRT Display
CN21	USB Port #3 and Port #4
CN22	LCD Inverter Voltage
CN23	Serial Port #3 (For Rev. B only)
CN24	Serial Port #5 (For Rev. B only)
CN25	Serial Port #4 (For Rev. B only)
CN26	Serial Port #6 (TTL/GPS) (For Rev. B only)
BAT1	External Battery
CFD1	Compact Flash Disk
MPC11	Mini-PCI
DIMM1	DDR SODIMM Slot

---



## 2.5 Setting Jumpers

---

You configure your card to match the needs of your application by setting jumpers. A jumper is the simplest kind of electric switch. It consists of two metal pins and a small metal clip (often protected by a plastic cover) that slides over the pins to connect them. To “close” a jumper you connect the pins with the clip.

To “open” a jumper you remove the clip. Sometimes a jumper will have three pins, labeled 1, 2 and 3. In this case you would connect either pins 1 and 2 or 2 and 3.

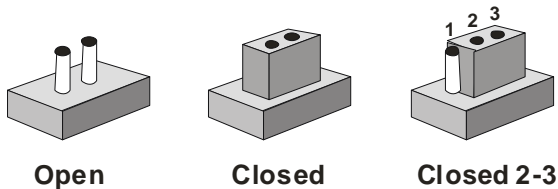

A pair of needle-nose pliers may be helpful when working with jumpers.

If you have any doubts about the best hardware configuration for your application, contact your local distributor or sales representative before you make any change. Generally, you simply need a standard cable to make most connections.

## 2.6 AT/ATX Power Type Selection (JP1)

---

JP1	Function
1-2	ATX Power Supply
	AT Power Supply (Default)

## 2.7 CFD Master/Slave Selection (JP2)

---

JP2	Function
1-2	Slave
2-3	Master (Default)

## 2.8 Clear CMOS (JP3)

---

JP3	Function
1-2	Normal (Default)
2-3	Clear CMOS

## 2.9 LCD Clock and LVDS Operating Voltage Selection (JP4)

---

Clock	
JP4	Function
1-3	Normal (Default)
3-5	Shift Clock
LVDS Operating Voltage	
JP4	Function
2-4	+5V
4-6	+3.3V (Default)

## 2.10 COM Ports RI/+5V/+12V Selection (JP5)

### COM 1

JP5	Function
1-2	+12V
3-4	+5V
5-6	RI (Default)

### COM 2

JP5	Function
7-8	+12V
9-10	+5V
11-12	RI (Default)

## 2.11 Inverter Voltage Selection (JP6)

JP6	Function
1-2	+5V (Default)
2-3	+12V

## 2.12 CFD Voltage Selection (JP7) (For Rev. B only)

JP7	Function
1-2	+5V (Default)
2-3	+3.3V

## 2.13 IDE Hard Drive Connector (CN1)

Pin	Signal	Pin	Signal
1	RESET#	2	Ground
3	D7	4	D8

5	D6	6	D9
7	D5	8	D10
9	D4	10	D11
11	D3	12	D12
13	D2	14	D13
15	D1	16	D14
17	D0	18	D15
19	Ground	20	N.C.
21	DREQ	22	Ground
23	IOW#	24	Ground
25	IOR#	26	Ground
27	IRDY	28	Ground
29	DACK#	30	Ground
31	IRQ14	32	N.C.
33	DA1	34	PDIAG#
35	DA0	36	DA2
37	CS#1	38	CS#3
39	Active LED#	40	Ground
41	+5Volt.	42	+5Volt.
43	Ground	44	N.C.

**Note:** The IDE interface on GENE-5315 supports two IDE devices including CF card. If you use a CF card, GENE-5315 allows one IDE device.

## 2.14 Floppy Connector (CN2)

Pin	Signal	Pin	Signal
1	Ground	2	DENSEL#
3	Ground	4	N.C.
5	Ground	6	N.C.

7	Ground	8	INDEX#
9	Ground	10	MTRA#
11	Ground	12	DRVB#
13	Ground	14	DRVA#
15	Ground	16	MTRB#
17	Ground	18	DIR#
19	Ground	20	STEP#
21	Ground	22	WDATA#
23	Ground	24	WGATE#
25	Ground	26	TRK0#
27	Ground	28	WPT#
29	N.C.	30	RDATA#
31	Ground	32	HDSEL#
33	N.C.	34	DSKCHG#

### 2.15 Parallel Port (CN3)

Pin	Signal	Pin	Signal
1	STB#	2	AFD#
3	PTD0	4	ERR#
5	PTD1	6	PINIT#
7	PTD2	8	SLIN#
9	PTD3	10	Ground
11	PTD4	12	Ground
13	PTD5	14	Ground
15	PTD6	16	Ground
17	PTD7	18	Ground
19	ACK#	20	Ground
21	BUSY	22	Ground
23	PE	24	Ground

25	SLCT	26	N.C.
----	------	----	------

### 2.16 Front Panel Connector (CN4)

Pin	Signal	Pin	Signal
1	Power On Button (-)	2	Power On Button (+)
3	IDE LED (-)	4	IDE LED (+)
5	External Buzzer (-)	6	External Buzzer (+)
7	Power LED (-)	8	Power LED (+)
9	Reset Switch (-)	10	Reset Switch (+)

### 2.17 USB Port #1 and Port #2 (CN5)

Pin	Signal	Pin	Signal
1	VDD	2	Ground
3	D0-	4	Ground
5	D0+	6	D1+
7	Ground	8	D1-
9	Ground	10	VDD

### 2.18 Digital I/O Connector (CN6)

Pin	Signal	Pin	Signal
1	Port 1	2	Port 2
3	Port 3	4	Port 4
5	Port 5	6	Port 6
7	Port 7	8	Port 8
9	+5Volt.	10	Ground

### DIO Address is 801H

BIOS Setting	Connector Definition	Address	IT8712 GPIO Setting
DIO-1	CN6 Pin 1	Bit 7	U1 Pin 20 (GPIO 27)

DIO-2	CN6 Pin 2	Bit 6	U1 Pin 21 (GPIO 26)
DIO-3	CN6 Pin 3	Bit 5	U1 Pin 22 (GPIO 25)
DIO-4	CN6 Pin 4	Bit 4	U1 Pin 23 (GPIO 24)
DIO-5	CN6 Pin 5	Bit 3	U1 Pin 24 (GPIO 23)
DIO-6	CN6 Pin 6	Bit 2	U1 Pin 25 (GPIO 22)
DIO-7	CN6 Pin 7	Bit 1	U1 Pin 26 (GPIO 21)
DIO-8	CN6 Pin 8	Bit 0	U1 Pin 27 (GPIO 20)

### 2.19 Audio Input/Output/CDin/MIC (CN7)

Pin	Signal	Pin	Signal
1	MIC	2	MIC_Vcc
3	Audio Ground	4	CD_GND
5	LINE_IN L	6	CD_L
7	LINE_IN R	8	CD_GND
9	Audio Ground	10	CD_R
11	LINE_OUT L	12	LINE_OUT R
13	Audio Ground	14	Audio Ground

### 2.20 ATX External 5VSB (CN8)

Pin	Signal
1	N.C.
2	Ground
3	N.C.
4	Ground
5	PS_ON#

---

6	+5 Volt. Standby
---	------------------

---

### 2.21 4P Power Socket (CN9)

---

Pin	Signal
1	+12 Volt.
2	Ground
3	Ground
4	+5 Volt.

### 2.22 LVDS LCD Connector (CN10)

---

Pin	Signal	Pin	Signal
1	N.C.	2	N.C.
3	VDD	4	Ground
5	CLK-	6	CLK+
7	VDD	8	Ground
9	D0-	10	D0+
11	D1-	12	D1+
13	D2-	14	D2+
15	D3-	16	D3+
17	N.C.	18	N.C.
19	N.C.	20	N.C.
21	N.C.	22	N.C.
23	N.C.	24	N.C.
25	N.C.	26	N.C.
27	VDD	28	Ground
29	N.C.	30	N.C.



## 2.23 PC/104 (CN11) (For Rev. A only)

### J1/P1

Pin	A	B
1	IOCHCK*	GND
2	D7	RSTDRV
3	D6	+5V
4	D5	IRQ9
5	D4	-5V
6	D3	DRQ2
7	D2	-12V
8	D1	ENDXFR*
9	D0	+12V
10	IOCHRDY	GND/KEY
11	AEN	SMEMW*
12	A19	SMEMR*
13	A18	IOW*
14	A17	IOR*
15	A16	DACK3*
16	A15	DRQ3
17	A14	DACK1*
18	A13	DRQ1
19	A12	REFRESH*
20	A11	SYSCLK
21	A10	IRQ7
22	A9	IRQ6
23	A8	IRQ5
24	A7	IRQ4
25	A6	IRQ3
26	A5	DACK2*
27	A4	TC
28	A3	BALE

29	A2	+5V
30	A1	OSC
31	A0	GND
32	GND	GND

**J2/P2**

Pin	D	C
1	GND	GND
2	MEMCS16*	SBHE*
3	IOCS16*	LA23
4	IRQ10	LA22
5	IRQ11	LA21
6	IRQ12	LA20
7	IRQ15	LA19
8	IRQ14	LA18
9	DACK0*	LA17
10	DRQ0	MEMR*
11	DACK5*	MEMW*
12	DRQ5	SD8
13	DACK6*	SD9
14	DRQ6	SD10
15	DACK7*	SD11
16	DRQ7	SD12
17	+5V	SD13
18	MASTER*	SD14
19	GND	SD15
20	GND	GND/KEY

**Note 1:** GENE-5315 does not support PC/104 way legacy ISA-DMA mode caused by AMD architecture.

**Note 2: Allocation Method of PC/104 Card for GENE-5315**

PC/104 connector on GENE-5315 cannot automatically get "Resource" when a new PC/104 card is added because of AMD

Geode's architecture limitation. The following steps for setup the resources manually for your reference.

1. Retrieve the resource of the PC/104 card. The information is typically contained in the manual of the PC/104 card.
2. Push a function key "Delete" to get into the BIOS.
3. Enable the resource of the device in BIOS setup.
4. Disable the resource of the device for which conflicts the resource of the device mentioned above in BIOS setup.
5. Save above BIOS setup and restart system.
6. Install the driver in operating system.
7. Open your Control Panel (click Start, then pick Settings then Control Panel). Double click the System icon and choose the Device Manager tab. Find the device for which you want to enable the device. Click the plus sign (+) next to the various categories click on the device you want to update, and then click on "Resource" and then choose the resource what should same as the hardware setup.

## 2.24 TTL LCD (CN12)

### For 24-bit TFT LCD

Pin	Signal	Pin	Signal
1	+5Volt.	2	+5Volt.
3	Ground	4	Ground
5	+3.3Volt.	6	+3.3Volt.
7	N.C.	8	Ground
9	B0	10	B1
11	B2	12	B3
13	B4	14	B5
15	B6	16	B7
17	G0	18	G1
19	G2	20	G3
21	G4	22	G5
23	G6	24	G7

25	R0	26	R1
27	R2	28	R3
29	R4	30	R5
31	R6	32	R7
33	Ground	34	Ground
35	Clock	36	VSYNC
37	DE	38	HSYNC
39	N.C.	40	N.C.

**For 18-bit TFT LCD**

Pin	Signal	Pin	Signal
1	+5Volt.	2	+5Volt.
3	Ground	4	Ground
5	+3.3Volt.	6	+3.3Volt.
7	N.C.	8	Ground
9	N.C.	10	N.C.
11	B0	12	B1
13	B2	14	B3
15	B4	16	B5
17	N/C	18	N/C
19	G0	20	G1
21	G2	22	G3
23	G4	24	G5
25	N.C.	26	N.C.
27	R0	28	R1
29	R2	30	R3
31	R4	32	R5
33	Ground	34	Ground
35	Clock	36	VSYNC

37	DE	38	HSYNC
39	N.C.	40	N.C.

## 2.25 Serial Port #2 (CN13)

### COM2/ RS-232 Mode

Pin	Signal	Pin	Signal
1	DCDB	2	RXB
3	TXB	4	DTRB
5	Ground	6	DSRB
7	RTSB	8	CTSB
9	RIB (+5V/ +12V)	10	N.C.

### COM2/ RS-422 Mode

Pin	Signal	Pin	Signal
1	TXD-	2	RXD+
3	TXD+	4	RXD-
5	Ground	6	N.C.
7	N.C.	8	N.C.
9	N.C.	10	N.C.

### COM2/ RS-485 Mode

Pin	Signal	Pin	Signal
1	TXD-	2	N.C.
3	TXD+	4	N.C.
5	Ground	6	N.C.
7	N.C.	8	N.C.
9	N.C.	10	N.C.

## 2.26 Fan Connector (CN14)

Pin	Signal
1	FAN Sense

2	+5 Volt.
3	Ground

### 2.27 Ethernet 10/100 Base-TX RJ-45 Phone Jack #1 (CN15)

Pin	Signal	Pin	Signal
1	RXD-	2	RXD+
3	RCT	4	N.C.
5	N.C.	6	TCT
7	TXD-	8	TXD+
9	ACT_LED	10	LINK_LED
11	+3.3 Volt.	12	SPD_LED
13	Ground	14	Ground

### 2.28 Ethernet 10/100 Base-TX RJ-45 Phone Jack #2 (CN16)

Pin	Signal	Pin	Signal
1	RXD-	2	RXD+
3	RCT	4	N.C.
5	N.C.	6	TCT
7	TXD-	8	TXD+
9	ACT_LED	10	LINK_LED
11	+3.3 Volt.	12	SPD_LED
13	Ground	14	Ground

### 2.29 IrDA Connector (CN17)

Pin	Signal
1	+5 Volt.
2	CIR_TX (Option)
3	RX

4	Ground
5	TX
6	CIR_RX (Option)

### 2.30 Mini-DIN PS/2 Keyboard/ Mouse Connector (CN18)

Pin	Signal	Pin	Signal
1	Keyboard Data	2	Keyboard Data
3	Ground	4	Ground
5	+5 Volt.	6	+5 Volt.
7	Shield	8	Shield

### 2.31 Serial Port #1 Connector (CN19)

#### COM 1

Pin	Signal	Pin	Signal
1	DCDA	2	RXA
3	TXA	4	DTRA
5	Ground	6	DSRA
7	RTSA	8	CTSA
9	RIA (+5V/ +12V)	10	N.C.

### 2.32 CRT Display Connector (CN20)

Pin	Signal	Pin	Signal
1	RED	9	+5 Volt.
2	GREEN	10	Ground
3	BLUE	11	N.C.
4	N.C.	12	DDCSDA
5	Ground	13	HSYNC
6	Ground	14	VSYNC
7	Ground	15	DDCSCL

---

8 Ground

---

### 2.33 USB Port #3 and Port #4 (CN21)

---

Pin	Signal	Pin	Signal
1	VDD	2	Ground
3	D2-	4	Ground
5	D2+	6	D3+
7	Ground	8	D3-
9	Ground	10	VDD

---

### 2.34 LCD Inverter Voltage (CN22)

---

Pin	Signal
1	VCC
2	Backlight Control
3	Ground
4	Ground
5	Enable

---

### 2.35 Serial Port #3 (CN23) (For Rev.B only)

---

#### COM 3

Pin	Signal	Pin	Signal
1	DCD3	2	RX3
3	TX3	4	DTR3
5	Ground	6	DSR3
7	RTS3	8	CTS3
9	RI3	10	N.C.

---



**2.36 Serial Port #5 (CN24) (For Rev.B only)****COM 5**

Pin	Signal	Pin	Signal
1	DCD5	2	RX5
3	TX5	4	DTR5
5	Ground	6	DSR5
7	RTS5	8	CTS5
9	RI5	10	N.C.

Note: An APM Mode limitation, OS (Operating System) recognizes serial port 5 & 6 of GENE-5315 Rev.B but is reverse. OS will reassign IRQ and give sequence of serial port 5 & 6 after uninstalling all of serial ports and second time boots in OS.

**2.37 Serial Port #4 (CN25) (For Rev.B only)****COM 4**

Pin	Signal	Pin	Signal
1	DCD4	2	RX4
3	TX4	4	DTR4
5	Ground	6	DSR4
7	RTS4	8	CTS4
9	RI4	10	N.C.

**2.38 Serial Port #6 (CN26) (TTL/GPS) (For Rev.B only)****COM 6**

Pin	Signal	Pin	Signal
1	N.C.	2	N.C.
3	Ground	4	N.C.
5	RX6	6	TX6
7	VBAT (+3 Volt.)	8	+3.3 Volt.
9	RESET#	10	Ground

**Note:** An APM Mode limitation, OS (Operating System) recognizes serial port 5 & 6 of GENE-5315 Rev.B but is reverse. OS will reassign IRQ and give sequence of serial port 5 & 6 after uninstalling all of serial ports and second time boots in OS.

### 2.39 External Battery (BAT1)

Pin	Signal
1	VBAT (+3 Volt.)
2	Ground

### 2.40 Compact Flash Disk Slot (CFD1)

Pin	Signal	Pin	Signal
1	Ground	26	Ground
2	D3	27	D11
3	D4	28	D12
4	D5	29	D13
5	D6	30	D14
6	D7	31	D15
7	CS#1	32	CS#3
8	Ground	33	Ground
9	Ground	34	IOR#
10	Ground	35	IOW#
11	Ground	36	+5 Volt.
12	Ground	37	IRQ14
13	+5 Volt.	38	+5 Volt.
14	Ground	39	CSEL#
15	Ground	40	N.C.
16	Ground	41	RESET#
17	Ground	42	IORDY
18	DA2	43	DREQ

19	DA1	44	DACK#
20	DA0	45	DASP#
21	D0	46	PDIAG#
22	D1	47	D8
23	D2	48	D9
24	IO16#	49	D10
25	Ground	50	Ground

## 2.41 Mini-PCI Slot (MPC11)

Standard Specification

## 2.42 DDR SODIMM Slot (DIMM1)

Standard SODIMM Slot

### **Note from AMD:**

Memory configurations supported. Only one DIMM or SODIMM is supported as long as the configuration requirements are met.

Devices	Max Memory <sup>1</sup>	Max GLIU Frequency	GLCP 4C0000Fh Upper Bits/Lower Bits	GLMC 2000001 Ah Bits <b>【26:24】</b>
4	512M	400MHz	F2F100FFh/ 56960004h	4
8	1G	400MHz	F2F100FFh/ 56960004h	4
4	512M	333MHz	F2F100FFh/ 56960004h	3
8	1G	333MHz	<b>F2F100FFh/ 56960004h</b>	3
16	2G	333MHz	<b>F2F100FFh/ 56960004h</b>	3

1: Maximum memory is assuming 1Gbit devices.

## Below Table for China RoHS Requirements

产品中有毒有害物质或元素名称及含量

## AAEON Main Board/ Daughter Board/ Backplane

部件名称	有毒有害物质或元素					
	铅 (Pb)	汞 (Hg)	镉 (Cd)	六价铬 (Cr(VI))	多溴联苯 (PBB)	多溴二苯醚 (PBDE)
印刷电路板 及其电子组件	×	○	○	○	○	○
外部信号 连接器及线材	×	○	○	○	○	○
<p><b>O:</b> 表示该有毒有害物质在该部件所有均质材料中的含量均在 SJ/T 11363-2006 标准规定的限量要求以下。</p> <p><b>X:</b> 表示该有毒有害物质至少在该部件的某一均质材料中的含量超出 SJ/T 11363-2006 标准规定的限量要求。</p> <p>备注: 此产品所标示之环保使用期限, 系指在一般正常使用状况下。</p>						

Chapter

3

**Award  
BIOS Setup**

### 3.1 System Test and Initialization

---

These routines test and initialize board hardware. If the routines encounter an error during the tests, you will either hear a few short beeps or see an error message on the screen. There are two kinds of errors: fatal and non-fatal. The system can usually continue the boot up sequence with non-fatal errors. Non-fatal error messages usually appear on the screen along with the following instructions:

Press <F1> to RESUME

Write down the message and press the F1 key to continue the boot up sequence.

#### **System configuration verification**

These routines check the current system configuration against the values stored in the CMOS memory. If they do not match, the program outputs an error message. You will then need to run the BIOS setup program to set the configuration information in memory.

There are three situations in which you will need to change the CMOS settings:

1. You are starting your system for the first time
2. You have changed the hardware attached to your system
3. The CMOS memory has lost power and the configuration information has been erased.

The GENE-5315 CMOS memory has an integral lithium battery backup for data retention. However, you will need to replace the complete unit when it finally runs down.

## 3.2 Award BIOS Setup

---

Awards BIOS ROM has a built-in Setup program that allows users to modify the basic system configuration. This type of information is stored in battery-backed CMOS RAM so that it retains the Setup information when the power is turned off.

### Entering Setup

Power on the computer and press <Del> immediately. This will allow you to enter Setup.

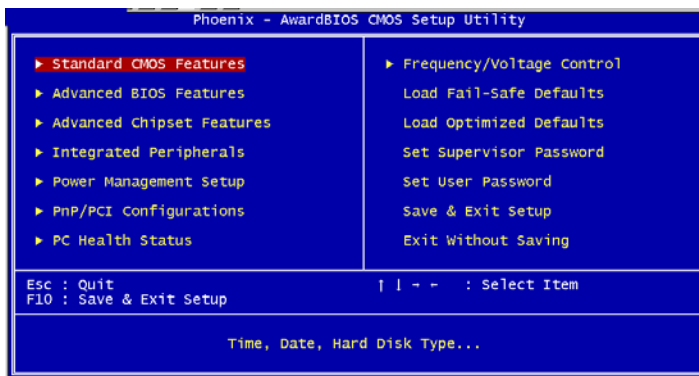

### Standard CMOS Features

Use this menu for basic system configuration. (Date, time, IDE, etc.)

### Advanced BIOS Features

Use this menu to set the advanced features available on your system.

## **Advanced Chipset Features**

Use this menu to change the values in the chipset registers and optimize your system performance.

## **Integrated Peripherals**

Use this menu to specify your settings for integrated peripherals. (Primary slave, secondary slave, keyboard, mouse etc.)

## **Power Management Setup**

Use this menu to specify your settings for power management. (HDD power down, power on by ring, KB wake up, etc.)

## **PnP/PCI Configurations**

This entry appears if your system supports PnP/PCI.

## **PC Health Status**

This menu allows you to set the shutdown temperature for your system.

## **Frequency/Voltage Control**

Use this menu to specify your settings for auto detect DIMM/PCI clock and spread spectrum.

## **Load Fail-Safe Defaults**

Use this menu to load the BIOS default values for the minimal/stable performance for your system to operate.



## Load Optimized Defaults

Use this menu to load the BIOS default values that are factory settings for optimal performance system operations. While AWARD has designated the custom BIOS to maximize performance, the factory has the right to change these defaults to meet their needs.

## Set Supervisor/User Password

Use this menu to set Supervisor/User Passwords.

## Save and Exit Setup

Save CMOS value changes to CMOS and exit setup.

## Exit Without Saving

Abandon all CMOS value changes and exit setup.

**You can refer to the “AAEON BIOS Item Description.pdf” file in the CD for the meaning of each setting in this chapter.**

Chapter

4

**Driver  
Installation**

## 4.1 Software Drivers

---

This chapter describes the operation and installation of the display drivers supplied on the Supporting CD-ROM that are shipped with your product. The onboard VGA adapter is based on the AMD LX VGA Flat Panel/CRT controller. This controller offers a large set of extended functions and higher resolutions. The purpose of the enclosed software drivers is to take advantage of the extended features of the AMD LX VGA Flat Panel/CRT controller.

### Hardware Configuration

Some of the high-resolution drivers provided in this package will work only in certain system configurations. If a driver does not display correctly, try the following:

1. Change the display controller to CRT-only mode, rather than flat panel or simultaneous display mode. Some high-resolution drivers will display correctly only in CRT mode.
2. If a high-resolution mode does not support your system, try to use a lower-resolution mode. For example, 1024 x 768 mode will not work on some systems, but 800 x 600 mode supports the most.

## 4.2 Necessary to Know

---

The instructions in this manual assume that you understand elementary concepts of MS-DOS and the IBM Personal Computer. Before you attempt to install any driver from the *Supporting CD-ROM*, you should:

- Know how to copy files from a CD-ROM to a directory on the hard disk
- Understand the MS-DOS directory structure

If you are uncertain about any of these concepts, please refer to the DOS or OS/2 user reference guides for more information before you proceed with the installation.

### Before you begin

The Supporting CD-ROM contains different drivers for corresponding Windows OS, please choose the specific driver for your Windows OS.

### 4.3 Installing VGA Driver

---

#### Win XP / Win XPe VGA

Place the Driver CD-ROM into your CD-ROM drive and follow the steps below to install.

1. Click on **Start** button.
2. Click on **Settings** button.
3. Click on **Control Panel** button.
4. Click on **System** button.
5. Select **Hardware** and click on **Device Manager...**
6. Double click on **Video Controller (VGA Compatible)**.
7. Click on **Update Driver...**
8. Click on **Next**.
9. Select **Search for a suitable driver...**, then click on **Next**.
10. Select **Specify a location**, then click on **Next**.
11. Click on **Browse**.
12. Select "lx\_win" file from CD-ROM (**Drivers/Step 1 – LX\_Graphics**) then click on **Open**.
13. Click on **OK**.
14. Click on **Next**.
15. Click on **Yes**.
16. Click on **Finish**.

**Note:** The user must install this system driver before install other device drivers.

## 4.4 Installing AES Driver

---

### Win XP / Win XPe AES

Place the Driver CD-ROM into your CD-ROM drive and follow the steps below to install.

1. Click on **Start** button.
2. Click on **Settings** button.
3. Click on **Control Panel** button.
4. Click on **System** button.
5. Select **Hardware** and click on **Device Manager...**
6. Double click on **Entertainment Encryption/Decryption Controller**.
7. Click on **Update Driver...**
8. Click on **Next**.
9. Select **Search for a suitable driver...**, then click on **Next**.
10. Select **Specify a location**, then click on **Next**.
11. Click on **Browse**.
12. Select "**LXAES**" file from CD-ROM (**Drivers/Step 2 – AES**) then click on **Open**.
13. Click on **OK**.
14. Click on **Next**.
15. Click on **Finish**.

## 4.5 Installing PCI to ISA Bridge Driver (For Rev.A only)

---

### Win XP / Win XPe System

Place the Driver CD-ROM into your CD-ROM drive and follow the following steps to install.

1. Click on **Start** button.
2. Click on **Settings** button.
3. Click on **Control Panel** button.
4. Click on **System** button.
5. Select **Hardware** and click on **Device Manager....**
6. Double click on **Other PCI Bridge Device**
7. Click on **Update Driver....**
8. Click on **Next**.
9. Select **Search for a suitable driver....**, then click on **Next**.
10. Select **Specify a location**, then click on **Next**.
11. Click on **Browse**.
12. Select "**ite**" file from CD-ROM (**Drivers/Step 3- PCI to ISA Bridge for RevA** ) then click on **open**.
13. Click on **OK**.
14. Click on **Next**.
15. Click on **Finish**.

## 4.6 Installing Ethernet Driver

---

1. Click on the **Step 4 – Lan** folder.
2. Double click on the **Setup** file located in the folder.
3. Follow the instructions that the window shows.
4. The system will help you install the driver automatically.

## 4.7 Ethernet Software Configuration

---

The onboard Ethernet interface supports all major network operating systems. I/O addresses and interrupts are easily configured via the Insyde BIOS Setup. To configure the medium type, to view the current configuration, or to run diagnostics, please refer to the following instruction:

1. Power the main board on. Ensure that the RSET8139.EXE file is located in the working drive.
2. At the prompt, type RSET8139.EXE and press <ENTER>. The Ethernet configuration program will then be displayed.
3. This simple screen shows all the available options for the Ethernet interface. Just highlight the option you wish to change by using the Up and DOWN keys. To change a selected item, press <ENTER>, and a screen will appear with the available options. Highlight your option and press <ENTER>. Each highlighted option has a helpful message guide displayed at the bottom of the screen for additional



information.

4. After you have made your selections and the configuration is what you want, press <ESC>. A prompt will appear asking if you want to save the configuration. Press "Y" if you want to save.

There are three very useful diagnostic functions offered in the Ethernet Setup Menu as follows:

1. Run EEPROM test
2. Run Diagnostics on Board
3. Run Diagnostics on Network

Each option has its own display screen, which shows the format and result of any diagnostic tests undertaken.

## 4.8 Installing Audio Driver

---

### Win XP / Win XPe Audio

Place the Driver CD-ROM into your CD-ROM drive and follow the steps below to install.

1. Click on **Start** button.
2. Click on **Settings** button.
3. Click on **Control Panel** button.
4. Click on **System** button.
5. Select **Hardware** and click on **Device Manager....**
6. Double click on **Multimedia Audio Controller**.
7. Click on **Update Driver....**

8. Click on **Next**.
9. Select **Search for a suitable driver...**, then click on **Next**.
10. Select **Specify a location**, then click on **Next**.
11. Click on **Browse**.
12. Select “**LXWDMAu**” file from CD-ROM (**Drivers/Step 5 – Audio**) then click on **Open**.
13. Double click on the “**bin**” folder
14. Click on **OK**.
15. Click on **Next**.
16. Click on **Yes**.
17. Click on **Finish**.

Appendix

**A**

# Programming the Watchdog Timer

## A.1 Programming

GENE-5315 utilizes ITE 8712 chipset as its watchdog timer controller. ( K version )

Below are the procedures to complete its configuration and the AAEON initial watchdog timer program is also attached based on which you can develop customized program to fit your application.

### Configuring Sequence Description

After the hardware reset or power-on reset, the ITE 8712 enters the normal mode with all logical devices disabled except KBC.

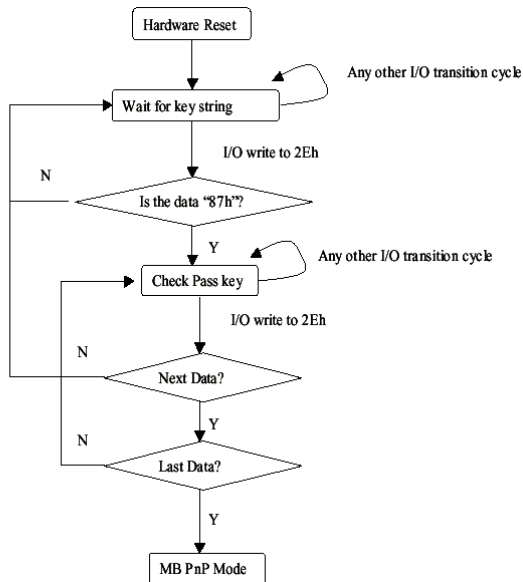

There are three steps to complete the configuration setup: (1) Enter the MB PnP Mode; (2) Modify the data of configuration registers; (3) Exit the MB PnP Mode. Undesired result may occur if the MB PnP Mode is not exited normally.

### (1) Enter the MB PnP Mode

To enter the MB PnP Mode, four special I/O write operations are to be performed during Wait for Key state. To ensure the initial state of the key-check logic, it is necessary to perform four write operations to the Special Address port (2EH). Two different enter keys are provided to select configuration ports (2Eh/2Fh) of the next step.

	Address Port	Data Port
87h, 01h, 55h, 55h:	2Eh	2Fh

### (2) Modify the Data of the Registers

All configuration registers can be accessed after entering the MB PnP Mode. Before accessing a selected register, the content of Index 07h must be changed to the LDN to which the register belongs, except some Global registers.

### (3) Exit the MB PnP Mode

Set bit 1 of the configure control register (Index=02h) to 1 to exit the MB PnP Mode.

#### WatchDog Timer Configuration Registers

LDN	Index	R/W	Reset	Configuration Register or Action
All	02H	W	N/A	Configuration Control
07H	71H	R/W	00H	WatchDog Timer Control Register
07H	72H	R/W	00H	WatchDog Timer Configuration Register
07H	73H	R/W	00H	WatchDog Timer Time-out Value (LSB) Register
07H	74H	R/W	00H	WatchDog Timer Time-out Value (MSB) Register

**Configure Control (Index=02h)**

This register is write only. Its values are not sticky; that is to say, a hardware reset will automatically clear the bits, and does not require the software to clear them.

Bit	Description
7-2	Reserved
1	Returns to the Wait for Key state. This bit is used when the configuration sequence is completed.
0	Resets all logical devices and restores configuration registers to their power-on states.

**WatchDog Timer Control Register (Index=71h, Default=00h)**

Bit	Description
7	WDT is reset upon a CIR interrupt
6	WDT is reset upon a KBC (Mouse) interrupt
5	WDT is reset upon a KBC (Keyboard) interrupt
4	WDT is reset upon a read or a write to the Game port base address
3-2	Reserved
1	Force Time-out. This bit is self-clearing
0	WDT status 1: WDT value reaches 0 0: WDT value is not 0

**WatchDog Timer Configuration Register (Index=72h, Default=00h)**

Bit	Description
7	WDT Time-out value select 1: Second 0: Minute
6	WDT output through KRST (pulse) enable
5	WDT Time-out value Extra select 1: 4s. 0: Determine by WDT Time-out value select (bit7 of this register)

---

4	WDT output through PWROK1/PWROK2 (pulse) enable
3	Select the interrupt level <sup>note</sup> for WDT

---

**WatchDog Timer Time-out Value (LSB) Register (Index=73h,  
Default=00h)**

**Bit Description**

---

7-0	WDT Time-out value 7-0
-----	------------------------

---

**WatchDog Timer Time-out Value (MSB) Register (Index=74h,  
Default=00h)**

**Bit Description**

---

7-0	WDT Time-out value 15-8
-----	-------------------------

---

## A.2 ITE8712 Watchdog Timer Initial Program

---

```
.MODEL SMALL
```

```
.CODE
```

Main:

```
CALL Enter_Configuration_mode
```

```
CALL Check_Chip
```

```
mov cl, 7
```

```
call Set_Logic_Device
```

```
;time setting
```

```
mov cl, 10 ; 10 Sec
```

```
dec al
```

Watch\_Dog\_Setting:

```
;Timer setting
mov al, cl
mov cl, 73h
call Superio_Set_Reg
;Clear by keyboard or mouse interrupt
mov al, 0f0h
mov cl, 71h
call Superio_Set_Reg
;unit is second.
mov al, 0C0H
mov cl, 72h
call Superio_Set_Reg
; game port enable
mov cl, 9
call Set_Logic_Device
```

Initial\_OK:

```
CALL Exit_Configuration_mode
MOV AH,4Ch
INT 21h
```

```
Enter_Configuration_Mode PROC NEAR
MOV SI,WORD PTR CS:[Offset Cfg_Port]
```



```
MOV DX,02Eh
MOV CX,04h
Init_1:
MOV AL,BYTE PTR CS:[SI]
OUT DX,AL
INC SI
LOOP Init_1
RET
Enter_Configuration_Mode ENDP

Exit_Configuration_Mode PROC NEAR
MOV AX,0202h
CALL Write_Configuration_Data
RET
Exit_Configuration_Mode ENDP

Check_Chip PROC NEAR

MOV AL,20h
CALL Read_Configuration_Data
CMP AL,87h
JNE Not_Initial

MOV AL,21h
CALL Read_Configuration_Data
```

CMP AL,12h

JNE Not\_Initial

Need\_Initial:

STC

RET

Not\_Initial:

CLC

RET

Check\_Chip ENDP

Read\_Configuration\_Data PROC NEAR

MOV DX,WORD PTR CS:[Cfg\_Port+04h]

OUT DX,AL

MOV DX,WORD PTR CS:[Cfg\_Port+06h]

IN AL,DX

RET

Read\_Configuration\_Data ENDP

Write\_Configuration\_Data PROC NEAR

MOV DX,WORD PTR CS:[Cfg\_Port+04h]

OUT DX,AL

XCHG AL,AH

MOV DX,WORD PTR CS:[Cfg\_Port+06h]

OUT DX,AL

RET

Write\_Configuration\_Data ENDP

Superio\_Set\_Reg proc near

push ax

MOV DX,WORD PTR CS:[Cfg\_Port+04h]

mov al,cl

out dx,al

pop ax

inc dx

out dx,al

ret

Superio\_Set\_Reg endp.Set\_Logic\_Device proc near

Set\_Logic\_Device proc near

push ax

push cx

xchg al,cl

mov cl,07h

call Superio\_Set\_Reg

pop cx

pop ax

ret

Set\_Logic\_Device endp

;Select 02Eh->Index Port, 02Fh->Data Port

Cfg\_Port DB 087h,001h,055h,055h

DW 02Eh,02Fh

**END Main**

*Note: Interrupt level mapping*

0Fh-Dh: not valid

0Ch: IRQ12

.

.

03h: IRQ3

02h: not valid

01h: IRQ1

00h: no interrupt selected

Appendix

**B**

## **I/O Information**

## B.1 I/O Address Map

Address	Description	User Address
000-01F	DMA Controller #1	000-000F
020-03F	Interrupt Controller #1, Master	020-021
040-05F	System Time	040-043
060-06F	8042 (Keyboard Controller)	060-064
070-07F	Real time Clock, NMI (non-maskable Interrupt) Mask	070-073
080-09F	DMA Page Register	080-08F
0A0-0BF	Interrupt Controller #2	0A0-0A1
0C0-0DF	DMA Controller #2	0C0-0DF
0F0-0FF	Math Coprocessor	0F0-0FF
1F0-1F7	Primary IDE Channel	1F0-1F7
2E8-2EF*	Serial Port 4	2E8-2EF
2F8-2FF	Serial Port 2	2F8-2FF
378-37F	Parallel Printer Port 1	378-37F
3B0-3DF	EGA / VGA card	3B0-3DF
3E8-3EF*	Serial Port 3	3E8-3EF
3F8-3FF	Serial Port 1	3F8-3FF
4E0-4E7*	Serial Port 5	4E0-4E7
4E8-4EF*	Serial Port 6	4E8-4EF

**Note:** The Serial Port 3-6 are for Rev.B only.

## B.2 1<sup>st</sup> MB Memory Address Map

Memory Address	Description
00000-9FFFF	System memory
A0000-BFFFF	VGA buffer
C0000-CBFFF	VGA BIOS
E0000-FFFFF	System BIOS

### B.3 IRQ Mapping Chart for Rev.A

IRQ0	System Timer	IRQ8	System CMOS / Real time clock
IRQ1	Keyboard	IRQ9	Microsoft ACPI – Compliant system
IRQ2	Cascade to IRQ Controller	IRQ10	Unused
IRQ3	COM2	IRQ11	Unused
IRQ4	COM1	IRQ12	PS/2 mouse
IRQ5	Unused	IRQ13	FPU
IRQ6	Floppy	IRQ14	Primary IDE
IRQ7	Printer	IRQ15	Reserved

### B.4 IRQ Mapping Chart for Rev.B

IRQ0	System Timer	IRQ8	System CMOS / Real time clock
IRQ1	Keyboard	IRQ9	COM6
IRQ2	Cascade to IRQ Controller	IRQ10	COM3
IRQ3	COM2	IRQ11	Microsoft ACPI – Compliant system
IRQ4	COM1	IRQ12	PS/2 mouse
IRQ5	COM4	IRQ13	FPU
IRQ6	Floppy	IRQ14	Primary IDE
IRQ7	COM5/ Printer	IRQ15	Reserved

### B.5 DMA Channel Assignments

DMA Channel	Function
0	Available
1	Available
2	Floppy
3	Available

Appendix

C

# Mating Connector



## C.1 List of Mating Connectors and Cables

The table notes mating connectors and available cables.

Connector Label	Function	Mating Connector		Available Cable	Cable P/N
		Vendor	Model no		
CN1	IDE Connector	MOLEX	87568-4463	IDE Cable	1701440500
CN2	Floppy Connector	HR	A2016H-N-2X 17P-A	Floppy Disk Drive Cable	1701340600
CN3	Parallel Port Connector	HR	A2016H-N-2X 13P-A	Parallel Port Cable	1701260201
CN4	Front Panel Connector	Neltron	2026B-10		N/A
CN5	USB Connector	Neltron	2026B-10	USB Cable	1709100201 or 170910020D (for GENE-5315W1)
CN6	Digital I/O Connector	Neltron	2026B-10		N/A
CN7	Audio Connector	Catch Electronics	052-D200-14P	Audio Cable	1700140510
CN8	ATX External 5VSB Connector	Catch Electronics	2418HJ-06	ATX External 5VSB Cable	1702200205
CN9	4P Power Connector	Neltron	8980-04		N/A
CN10	LVDS LCD Connector	HIROSE	DF13-30DS-1 .25C		N/A
CN12	TTL LCD Connector	HIROSE	DF13-40DS-1 .25C		N/A
CN13	Serial Port 2 Connector	Neltron	2026B-10	Serial Port Cable	1701100207

CN14	System FAN Connector	Hobase Technology	2503-H-3		N/A
CN15	Ethernet Connector	Neltron	7001-8P8C		N/A
CN16	Ethernet Connector	Neltron	7001-8P8C		N/A
CN17	IrDA Connector	Neltron	2026A-06		N/A
CN18	Mini-Din PS/2 Connector	Catch Electronics	MD06F011 121	Keyboard & Mouse Cable	1700060192
CN19	Serial Port 1 Connector	AMP	707-09F		N/A
CN20	CRT Display Connector	Hobase Technology	708HD-15M		N/A
CN21	USB Connector	Neltron	2026B-10	USB Cable	1709100201 or 170910020D (for GENE-5315W1)
CN22	LCD Inverter Voltage	Catch Electronics	2.0mm pitch 5 pin (CATCH HS-5P-2.0, JST PHR-5 or compatible)	LCD Inverter Cable	N/A
CN23 (Rev.B)	Serial Port 3 Connector	Neltron	2026B-10	Serial Port Cable	1701100207
CN24 (Rev.B)	Serial Port 5 Connector	Neltron	2026B-10	Serial Port Cable	1701100207
CN25 (Rev.B)	Serial Port 4 Connector	Neltron	2026B-10	Serial Port Cable	1701100207
CN26 (Rev.B)	Serial Port 6 Connector	Catch Electronics	1.0mm pitch 10 pin (CATCH HS-10P-1.0 or compatible)	N/A	N/A