

**ACD-515D**

15.6" WXGA Infotainment Touch Display  
On Screen Display Control  
IP-65 Front Bezel  
Projected Capacitive Multi-Touch Screen

## Copyright Notice

This document is copyrighted, 2015. All rights are reserved. The original manufacturer reserves the right to make improvements to the products described in this manual at any time without notice.

No part of this manual may be reproduced, copied, translated, or transmitted in any form or by any means without the prior written permission of the original manufacturer. Information provided in this manual is intended to be accurate and reliable. However, the original manufacturer assumes no responsibility for its use, nor for any infringements upon the rights of third parties, which may result from its use.

The material in this document is for product information only and is subject to change without notice. While reasonable efforts have been made in the preparation of this document to assure its accuracy, AAEON, assumes no liabilities resulting from errors or omissions in this document, or from the use of the information contained herein.

AAEON reserves the right to make changes in the product design without notice to its users.

## Acknowledgments

---

- Intel® is registered trademarks of Intel® Corporation.
- IBM, PC/AT, PS/2 are trademarks of International Business Machines Corporation.
- Microsoft® Windows is a registered trademark of Microsoft® Corporation.
- RTL is a trademark of Realtek Semi-Conductor Co., Ltd.
- C&T is a trademark of Chips and Technologies, Inc.
- UMC is a trademark of United Microelectronics Corporation.
- ITE is a trademark of Integrated Technology Express, Inc.
- SiS is a trademark of Silicon Integrated Systems Corp.
- VIA is a trademark of VIA Technology, Inc.

**All other product names or trademarks are properties of their respective owners.**

## Packing List

---

The LCD monitor comes with the following standard parts shown as below. Check and make sure they are included and in good condition. If anything is missing or damaged, contact the dealer immediately.

- 1 ACD-515D
- 1 Utility CD-ROM  
Contains User's Manual (in PDF format), Drivers and Utilities
- 1 VGA Cable
- 1 USB Cable
- 1 AC/DC 12V Power Adapter with Lock

If any of these items are missing or damaged, you should contact your distributor or sales representative immediately.

## Safety & Warranty

---

1. Read these safety instructions carefully.
2. Keep this user's manual for later reference.
3. Disconnect this equipment from any AC outlet before cleaning. Do not use liquid or spray detergents for cleaning. Use a damp cloth.
4. For pluggable equipment, the power outlet must be installed near the equipment and must be easily accessible.
5. Keep this equipment away from humidity.
6. Put this equipment on a reliable surface during installation. Dropping it or letting it fall could cause damage.
7. The openings on the enclosure are for air convection. Protect the equipment from overheating. **DO NOT COVER THE OPENINGS.**
- 8. Make sure the voltage of the power source is correct before connecting the equipment to the power outlet.**
9. Position the power cord so that people cannot step on it. Do not place anything over the power cord.
10. All cautions and warnings on the equipment should be noted.
11. If the equipment is not used for a long time, disconnect it from the power source to avoid damage by transient over-voltage.
12. Never pour any liquid into an opening. This could cause fire or electrical shock.
13. Never open the equipment. For safety reasons, only qualified service personnel should open the equipment.

**14. If any of the following situations arises, get the equipment****checked by service personnel:**

- a. The power cord or plug is damaged.
- b. Liquid has penetrated into the equipment.
- c. The equipment has been exposed to moisture.
- d. The equipment does not work well, or you cannot get it to work according to the users manual.
- e. The equipment has been dropped and damaged.
- f. The equipment has obvious signs of breakage.

**15. DO NOT LEAVE THIS EQUIPMENT IN AN UNCONTROLLED ENVIRONMENT WHERE THE STORAGE TEMPERATURE IS BELOW -20° C (-4°F) OR ABOVE 60° C (140° F). IT MAY DAMAGE THE EQUIPMENT.****FCC****Warning!**

**This device complies with Part 15 FCC Rules. Operation is subject to the following two conditions: (1) this device may not cause harmful interference, and (2) this device must accept any interference received including interference that may cause undesired operation.**

**Caution:**

*It may cause the danger of explosion if battery is incorrectly replaced. Replace only with same or equivalent type recommended by the manufacturer.*

**Attention:**

Il y a un risque d'explosion si la batterie est remplacée de façon incorrecte.

Ne la remplacer qu'avec le même modèle ou équivalent recommandé par le constructeur. Recycler les batteries usées en accord avec les instructions du fabricant et les directives gouvernementales de recyclage.

## Below Table for China RoHS Requirements

产品中有毒有害物质或元素名称及含量

## AAEON Display

部件名称	有毒有害物质或元素					
	铅 (Pb)	汞 (Hg)	镉 (Cd)	六价铬 (Cr(VI))	多溴联苯 (PBB)	多溴二苯醚 (PBDE)
印刷电路板 及其电子组件	×	○	○	○	○	○
外部信号 连接器及线材	×	○	○	○	○	○
外壳	×	○	○	○	○	○
液晶模块	×	○	○	○	○	○
触控模块	×	○	○	○	○	○
电源	×	○	○	○	○	○
<p><b>O:</b> 表示该有毒有害物质在该部件所有均质材料中的含量均在 <b>SJ/T 11363-2006</b> 标准规定的限量要求以下。</p> <p><b>X:</b> 表示该有毒有害物质至少在该部件的某一均质材料中的含量超出 <b>SJ/T 11363-2006</b> 标准规定的限量要求。</p> <p><b>备注:</b></p> <p>一、此产品所标示之环保使用期限, 系指在一般正常使用状况下。</p> <p>二、上述部件物质触控模块为选购品。</p>						

# Contents

## Chapter 1 General Information

1.1 Introduction.....	1-2
1.2 Features .....	1-3
1.3 General Specification .....	1-4
1.4 Dimension .....	1-6

## Chapter 2 Hardware Installation

2.1 Before Unpacking.....	2-2
2.2 Connecting Power .....	2-3
2.3 Connecting to the Computer .....	2-4
2.4 VGA Port Connector.....	2-5
2.5 DVI Port Connector .....	2-6
2.6 Serial Port Connector For Touch Screen.....	2-7
2.7 Mini USB Connector For Touch Screen.....	2-8
2.8 VESA Wall Mounting.....	2-9

## Chapter 3 On Screen Display Control

3.1 On Screen Display (OSD) Board Description. ....	3-2
3.2 OSD Main Menu: Push The MENU Keys.....	3-3
3.3 Select Input Source. ....	3-4
3.4 Contrast/ Brightness- Submenu. ....	3-5
3.5 Geometry Menu.....	3-6
3.6 Color Temperature- Submenu OSD Main Menu: Push	



The MENU Keys.....	3-7
3.7 RGB Color- Submenu. ....	3-8
3.8 Language- Submenu.....	3-9
3.9 Auto Config- Submenu. ....	3-10
3.10 Mode Resolution- Submenu Chapter.....	3-11
3.11 Exit Menu- Submenu.....	3-12

## **Chapter 4 Touch Screen Driver Installation**

4.1 Introduction.....	4-2
4.2 Installing Driver for Windows® XP/ Windows® 7 / Linux .....	4-2

Chapter

1

**General  
Information**

## 1.1 Introduction

---

Thank you for purchasing of the Industry Display Panel TFT LCD monitor - a marvelous contribution of cutting-edge technology.

The LCD monitor has been designed with serious thoughts to present the best performance for most applications. Symbol of elegance, its compact and slim profile are well suited in working locations where space is at a premium.

The TFT LCD monitor displays sharper, more brilliant, crisper and flicker-free images. Complying with the power management regulations of VESA DPMS, the LCD monitor is extremely energy efficient and a power saver. Plus, the LCD monitor has extremely low radiation emissions and near zero electromagnetic fields which are supreme benefits.

Fully compatible with PC system, the LCD monitor provides full interface for all sorts of related standards. Supported by “Plug & Play” complying with DDC1/DDC2B, installing the LCD monitor is absolutely trouble free.

The On Screen Display menu provides user a convenient interface to make right adjustment for optimum display performance.

## **1.2 Features**

---

- 15.6" WXGA (1366 x 768) TFT LED Type LCD Display
- Easy-To-Clean: Multi-Touch Window Design (Two-Point)
- Easy To Maintain: USB Ports On Two Sides
- IPx1 Water-proof Design For Whole System
- Anti-Scratch Surface (7H Hardness)

### 1.3 General Specification

---

- **Type** Color TFT
- **Size** 15.6"
- **Construction** Plastic front bezel and steel back chassis
- **Mounting** VESA/ Wallmount
- **Input signal** VGA, DVI
- **Control** OSD (On Screen Display) on the panel
- **Power Supply** External power adapter
- **Dimension** 15.51" (W) x 10.71"(H) x 2.36"(D) (394mm x 272mm x 59mm)
- **Gross Weight** 11 lb (5 Kg)
- **Net Weight** 6.6 lb (3 Kg)
- **Power Input** 12V DC, 5A
- **Brightness** 300 cd/m<sup>2</sup> (TYP.)
- **MTBF** 50,000 hrs
- **Contrast Ratio** 1000:1
- **Viewing Angle** 170°(H)/ 160°(V)
- **Resolution** 1366 x 768
- **Display Modes** Full Screen in 640x480, 800x600, 1024x768, 1280x1024 Modes
- **Color** 16.7M colors

#### Touchscreen

- **Type** Projected Capacitive

- **Resolution** 2048 x 2048
- **Light transmission** >90% (Pure)
- **Controller** USB interface

### Environmental

- **Operating temperature** 32°F~ 104°F (0°C to 40°C)
- **Storage Temperature** -4°F~ 158°F (-20°C to 70°C)
- **Storage Humidity** 5~90% @ 40°C, non-condensing
- **Vibration** 1g rms/5-500Hz/random operation
- **Shock** 20 G peak acceleration (11 msec. duration)
- **EMC** CE/FCC Class A

### 1.4 Dimension

---

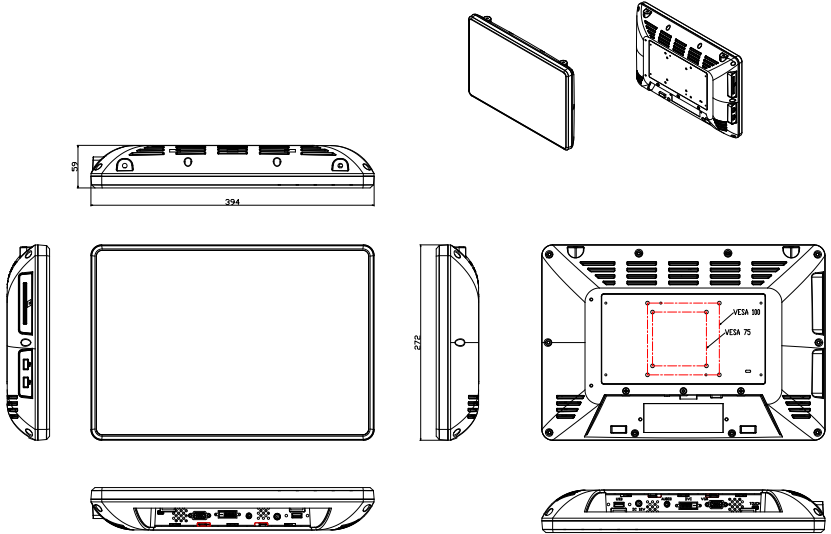

GW:5.5KG  
NW:3.6KG

Chapter

2

**Hardware  
Installation**



## 2.1 Before Unpacking

---

It is very important to place the LCD Display in a suitable environment.

- The surface for placing the LCD Display should be stable and level.
- Make sure the place has good ventilation, and out of direct sunlight; away from sources of excessive dust, dirt, heat, water, moisture and vibration.
- Convenience for connecting the LCD Display the related facilities should be well considered too.

## 2.2 Connecting Power

---

To power on the LCD Display, use the provided AC-DC adapter and the power cord to connect to the power output socket of the monitor. Fasten the connector securely.



## 2.3 Connecting to the Computer

---

Turn off the computer and the LCD Display before connecting.

- Use the Monitor-to-PC VGA · DVI cable to connect the LCD Display to your computer. The cable heads are the same on either side.
- Fasten the connectors securely.



## 2.4 VGA Port Connector

---

This DB-15 connector can be connected to the system via the external 15-pin DB-15 connector through the I/O from this unit.

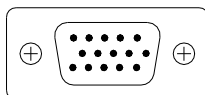

Pin	Signal	Pin	Signal
1	Red	2	Green
3	Blue	4	N.C.
5	GND	6	GND
7	GND	8	GND
9	N.C.	10	GND
11	N.C.	12	SDA
13	HSYNC	14	VSYNC
15	SCL		

## 2.5 DVI Port Connector

Connecting a standard DVI-D connector through I/O port of this unit.

This connector supports digital signals only

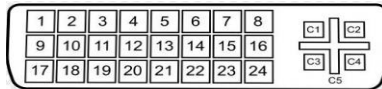

Pin	Signal	Pin	Signal
1	N.C.	2	TMDS Data 2+
3	TMDS Data 2/4 shield	4	TMDS Data 4-
5	TMDS Data 4+	6	DDC clock
7	DDC data	8	N.C.
9	TMDS Data 1-	10	TMDS Data 1
11	TMDS Data 1/3 shield	12	TMDS Data 3-
13	TMDS Data 3+	14	+5V
15	Ground	16	Hot plug detect
17	TMDS data 0-	18	TMDS data 0+
19	TMDS data 0/5 shield	20	TMDS data 5-
21	TMDS data 5+	22	TMDS clock shield
23	TMDS clock+	24	TMDS clock-
C1	N.C.	C2	N.C.
C3	N.C.	C4	N.C.
C5	N.C.		

## 2.6 Serial Port Connector For Touch Screen

---

This pin definition of the connector will be referred when a touch screen has been installed. It must be connected to the RS-232 port of the PC. The touch screen cable is included with all orders which include the optional RS-232 Touch Screen.

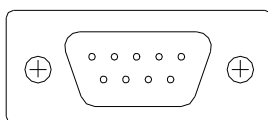

---

Pin	Signal	Pin	Signal
1	Not Used	2	RXD, Receive Data
3	TXD, Transmit Data	4	Not Used
5	GND, Ground	6	Not Used
7	Not Used	8	Not Used
9	Not Used	10	Not Used

---

## 2.7 Mini USB Connector For Touch Screen

---

This pin definition of the connector will be referred when a touch screen has been installed. It must be connected to the Mini USB port of the PC. The touch screen cable is included with all orders which include the optional Mini USB Touch Screen.

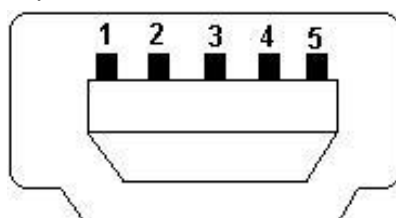

---

Pin	Signal	Pin	Signal
1	+5V	2	DATA (-)
3	DATA (+)	4	N.C.
5	GND, Ground		

---

## 2.8 VESA Wall Mounting

---

Mounting the LCD Display with UL Listed Wallmount Bracket only. The LCD Display can be mounted on a monitor arm or wallmount plate.

*Caution:*

*When mounting the LCD Display, take care to tighten the retention screws or bolts until fully secured, but do not over tighten. Over tightening the retention screws or bolts may cause them to become stripped, rendering them useless.*

### Monitor Arm or Wallmount Plate Installation

The LCD Display has Video Electronics Standards Association (VESA) standard mounting holes tapped into the rear panel. The standard holes are M4 set at 75mm x 75mm apart.

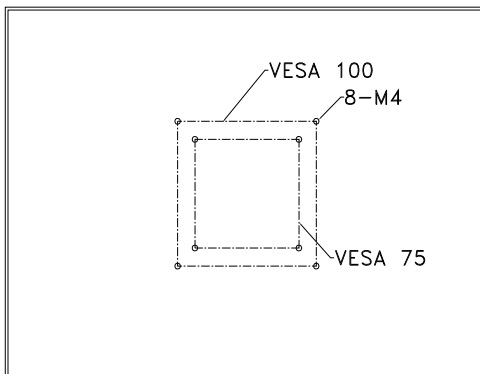



## VESA Mounting Holes

To mount the LCD Display onto a monitor arm or wallmount plate, please follow the steps below.

Step 1: Line up the threaded holes on the monitor rear panel with the screw holes on the monitor arm or wallmount plate.

Step 2: Secure the monitor to the arm or stand with the retention screws supplied with the monitor arm or stand.

Chapter

3

**On Screen  
Display Control**







### 3.1 On Screen Display (OSD) Board Description

Buttons	Description
Power	➤ Turn the monitor power ON or OFF.
Menu / Enter	➤ Activate the OSD menu.
	➤ Enter/confirm the selected option.
UP / Right / Increase / Input select	➤ Move the selector to the next option.
	➤ Increase the gauge value of the selected option.
	➤ Change input source.
Down/ Left / Decrease	➤ Move the selector to the previous option.
	➤ Decrease the gauge value of the selected option.
Auto	➤ Automatically adjust the clock, phase, H-position and V-position.
	➤ Value to the most optimal settings. Use full screen when enabling this function.

### 3.2 OSD Main Menu: Push The MENU Keys







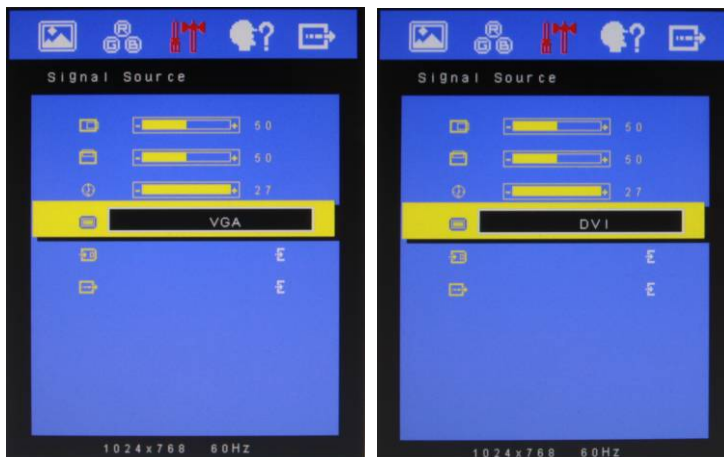

#### Available Key Functions

		Power On/Off the LCD Monitor
	or 	Increase the gaguge value of the selected option
	or 	Decrease the gaguge value of the selected option
	or <b>AUTO</b>	Slected to confirm
	or <b>MENU</b>	Return to last menu

### 3.3 Select Input Source





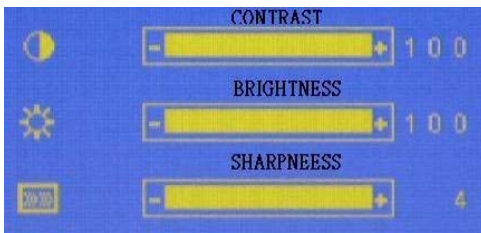

#### Available Key Functions

		Power On/Off the LCD Monitor	
	or		Increase the gaguge value of the selected option
	or		Decrease the gaguge value of the selected option
	or	AUTO	Slected to confirm
	or	MENU	Return to last menu

### 3.4 Contrast/ Brightness- Submenu







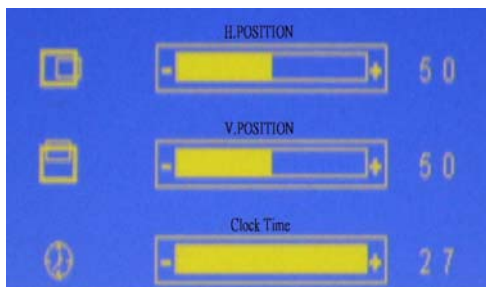

#### Available Key Functions

		Power On/Off the LCD Monitor
	or $\Delta$	Increase the gaguge value of the selected option
	or $\nabla$	Decrease the gaguge value of the selected option
	or <b>AUTO</b>	Slected to confirm
	or <b>MENU</b>	Return to last menu

### 3.5 Geometry Menu







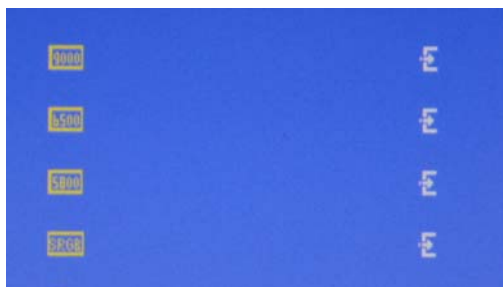
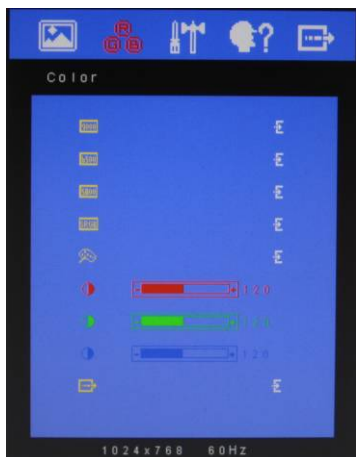

### Available Key Functions

		Power On/Off the LCD Monitor
	or 	Increase the gaguge value of the selected option
	or 	Decrease the gaguge value of the selected option
	or <b>AUTO</b>	Slected to confirm
	or <b>MENU</b>	Return to last menu

### 3.6 Color Temperature- Submenu



#### Available Key Functions





		Power On/Off the LCD Monitor
 or 		Increase the gaguge value of the selected option
 or 		Decrease the gaguge value of the selected option
 or <b>AUTO</b>		Slected to confirm
 or <b>MENU</b>		Return to last menu

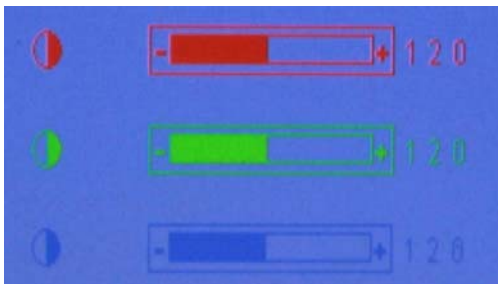
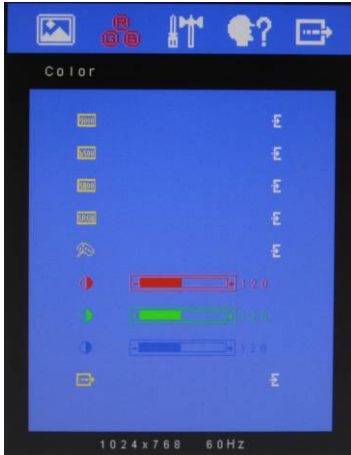

### 3.7 RGB Color- Submenu







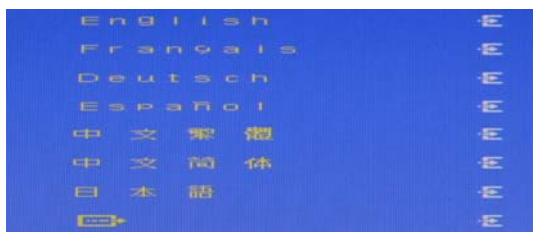

#### Available Key Functions

		Power On/Off the LCD Monitor
 or $\Delta$		Increase the gaguge value of the selected option
 or $\nabla$		Decrease the gaguge value of the selected option
 or <b>AUTO</b>		Slected to confirm
 or <b>MENU</b>		Return to last menu

### 3.8 Language- Submenu







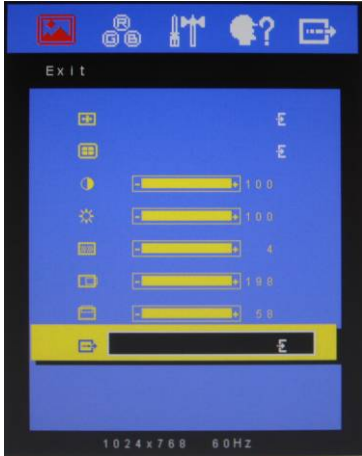

#### Available Key Functions

		Power On/Off the LCD Monitor
	or 	Increase the gaguge value of the selected option
	or 	Decrease the gaguge value of the selected option
	or <b>AUTO</b>	Slected to confirm
	or <b>MENU</b>	Return to last menu

### 3.9 Auto Config- Submenu







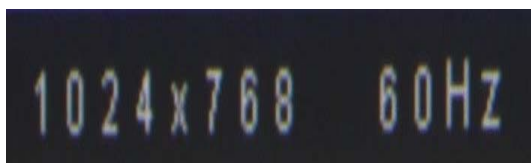

#### Available Key Functions

		Power On/Off the LCD Monitor
	or 	Increase the gaguge value of the selected option
	or 	Decrease the gaguge value of the selected option
	or <b>AUTO</b>	Slected to confirm
	or <b>MENU</b>	Return to last menu

### 3.10 Mode Resolution- Submenu







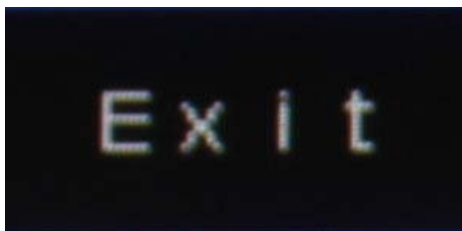

#### Available Key Functions

		Power On/Off the LCD Monitor
	or 	Increase the gaguge value of the selected option
	or 	Decrease the gaguge value of the selected option
	or <b>AUTO</b>	Slected to confirm
	or <b>MENU</b>	Return to last menu

### 3.11 Exit Menu- Submenu



#### Available Key Functions

		Power On/Off the LCD Monitor
	or 	Increase the gaguge value of the selected option
	or 	Decrease the gaguge value of the selected option
	or <b>AUTO</b>	Slected to confirm
	or <b>MENU</b>	Return to last menu

Chapter

4

# Touch Screen Driver Installation

## 4.1 Introduction

---

The optional ACD-515D Series touch screen uses Projected Capacitive Multi-Touch technology to provide more accurate sensing capacity than other technologies. The touch screen is specially designed for infotainment environments, and has been approved by FCC Class A standards.

## 4.2 Installing Driver for Windows® XP/ Windows® 7 / Linux

---

The touch screen has drivers for Windows® XP、 Windows® 7 and Linux . You should read the instructions in this chapter carefully before you attempt installation.

**Note 1:** We don't install driver for Windows®7 since Windows® 7 has been built in multi-touch driver

**Note 2:** ACD series just support single touch on Windows® XP, and need to install the driver.

For Linux Fedora 14 kernel 2.6.35-45.fc14 OS:

CD-ROM:

\\TouchScreen-DRV\Galax Touch \ Linux\ eGTouch\_v1.00.0726.L-x32

### 1. Open System

1-1. Select Applications

1-2. Select System Tools

---

1-3. Select Terminal

1-4. Input Command → su and System Password

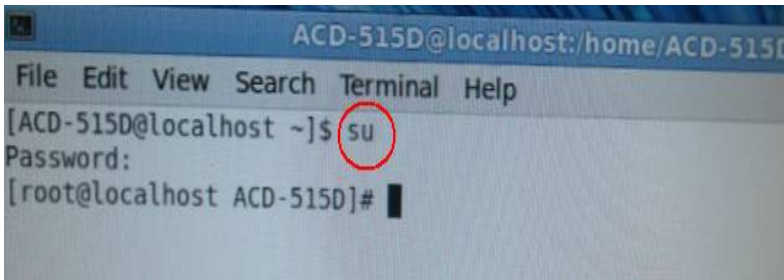
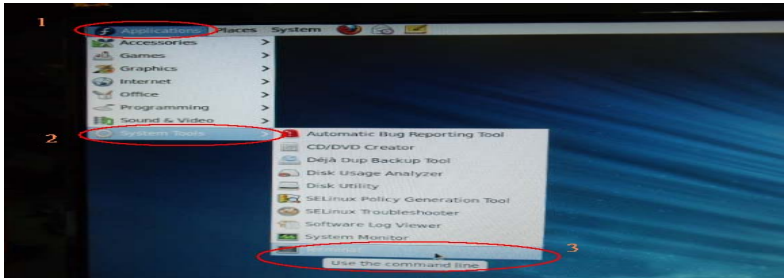

2. Input command → cd Desktop

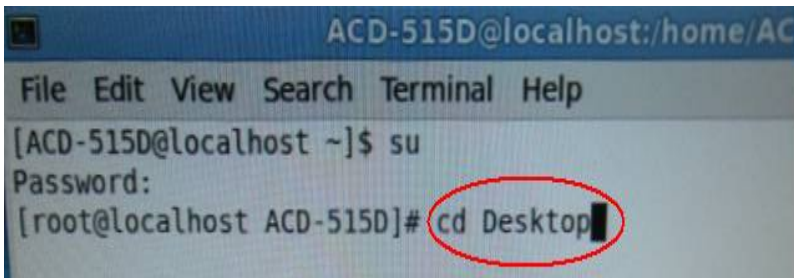



2-1 Input command → ls (This is the lowercase L)

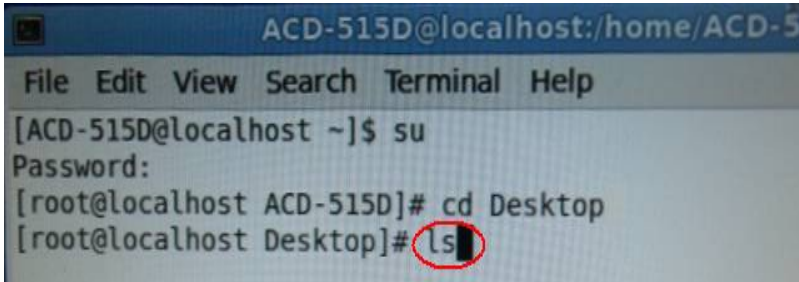

```
ACD-515D@localhost:/home/ACD-515D
File Edit View Search Terminal Help
[ACD-515D@localhost ~]$ su
Password:
[root@localhost ACD-515D]# cd Desktop
[root@localhost Desktop]# ls
```

2-2 all files of desktop will appear in window.

(Please copy the driver on desktop first.)

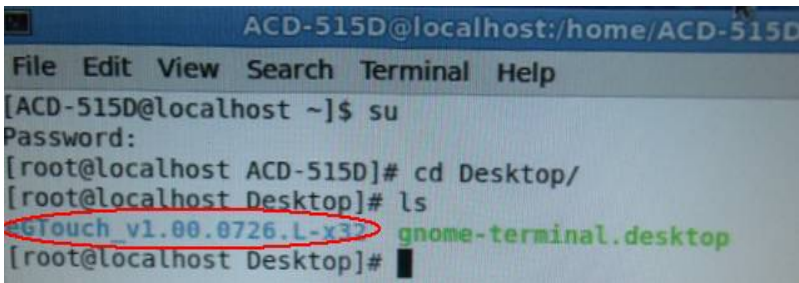

```
ACD-515D@localhost:/home/ACD-515D
File Edit View Search Terminal Help
[ACD-515D@localhost ~]$ su
Password:
[root@localhost ACD-515D]# cd Desktop/
[root@localhost Desktop]# ls
eGTouch_v1.00.0726.L-x32  gnome-terminal.desktop
[root@localhost Desktop]#
```

2-3 Input command → cd eGTouch\_v1.00.0726.L-x32

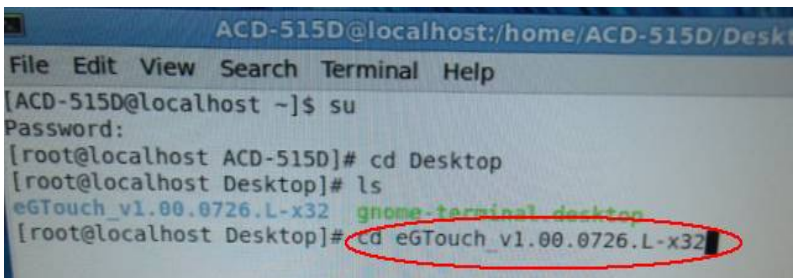

```
ACD-515D@localhost:/home/ACD-515D/Desktop
File Edit View Search Terminal Help
[ACD-515D@localhost ~]$ su
Password:
[root@localhost ACD-515D]# cd Desktop
[root@localhost Desktop]# ls
eGTouch_v1.00.0726.L-x32  gnome-terminal.desktop
[root@localhost Desktop]# cd eGTouch_v1.00.0726.L-x32
```

2-4 Input command → ls (This is the lowercase L)

```
ACD-515D@localhost:/home/ACD-515D/Desktop/eGTouch
File Edit View Search Terminal Help
[ACD-515D@localhost ~]$ su
Password:
[root@localhost ACD-515D]# cd Desktop/
[root@localhost Desktop]# ls
eGTouch_v1.00.0726.L-x32  gnome-terminal.desktop
[root@localhost Desktop]# cd eGTouch_v1.00.0726.L-x32/
[root@localhost eGTouch_v1.00.0726.L-x32]# ls
```

2-5 The information of the folder, "eGTouch\_v1.00\_0726.L-x32", would appear in the window.

```
File Edit View Search Terminal Help
[ACD-515D@localhost ~]$ su
Password:
[root@localhost ACD-515D]# cd Desktop/
[root@localhost Desktop]# ls
eGTouch_v1.00.0726.L-x32  gnome-terminal.desktop
[root@localhost Desktop]# cd eGTouch_v1.00.0726.L-x32/
[root@localhost eGTouch_v1.00.0726.L-x32]# ls
eGTouch32  eGTouch32.tar.gz  setup.sh
[root@localhost eGTouch_v1.00.0726.L-x32]#
```

2-6 Input command → Execute Touch Driver

```
ACD-515D@localhost:/home/ACD-515D/Desktop/eGTouch_v1
File Edit View Search Terminal Help
[ACD-515D@localhost ~]$ su
Password:
[root@localhost ACD-515D]# cd Desktop/
[root@localhost Desktop]# ls
eGTouch_v1.00.0726.L-x32  gnome-terminal.desktop
[root@localhost Desktop]# cd eGTouch_v1.00.0726.L-x32/
[root@localhost eGTouch_v1.00.0726.L-x32]# ls
eGTouch32  eGTouch32.tar.gz  setup.sh
[root@localhost eGTouch_v1.00.0726.L-x32]# sh setup.sh
```

### 3. Reboot

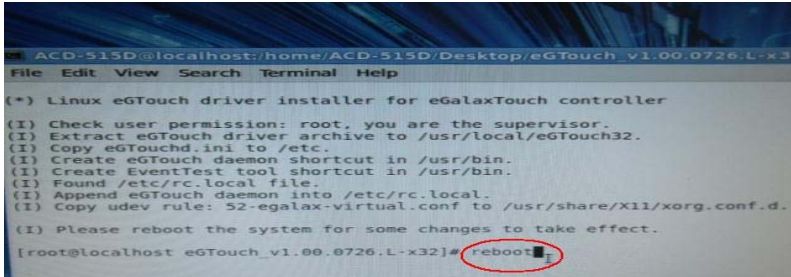

```
ACD-515D@localhost:/home/ACD-515D/Desktop/eGTouch_v1.00.0726.L-x32
File Edit View Search Terminal Help

(*) Linux eGTouch driver installer for eGalaxTouch controller
(I) Check user permission: root, you are the supervisor.
(I) Extract eGTouch driver archive to /usr/local/eGTouch32.
(I) Copy eGTouchd.ini to /etc.
(I) Create eGTouch daemon shortcut in /usr/bin.
(I) Create EventTest tool shortcut in /usr/bin.
(I) Found /etc/rc.local file.
(I) Append eGTouch daemon into /etc/rc.local.
(I) Copy udev rule: 52-egalax-virtual.conf to /usr/share/X11/xorg.conf.d.
(I) Please reboot the system for some changes to take effect.

[root@localhost eGTouch_v1.00.0726.L-x32]# reboot
```

### 4. Change the permission

Input command → `chmod 777 /etc/eGTouchd.ini`

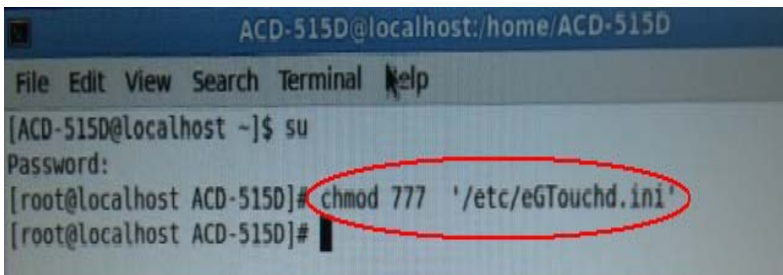

```
ACD-515D@localhost:/home/ACD-515D
File Edit View Search Terminal Help

[ACD-515D@localhost ~]$ su
Password:
[root@localhost ACD-515D]# chmod 777 '/etc/eGTouchd.ini'
[root@localhost ACD-515D]#
```

5. Select Computer (You can modify the value of the Y axis to reverse action principle.)

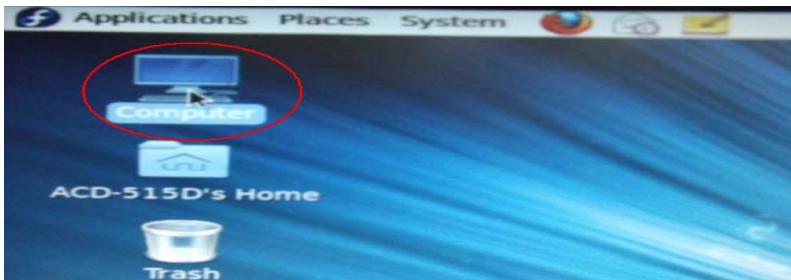

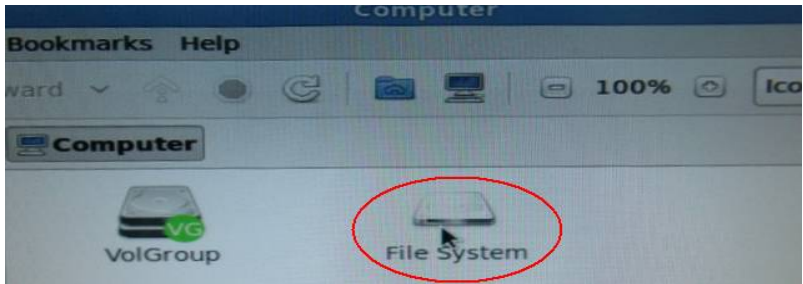
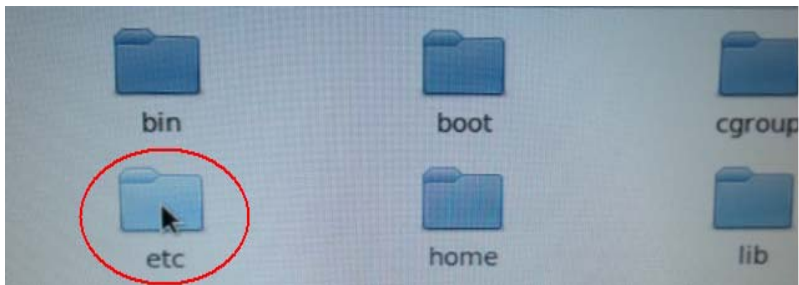
**6. Select “File System”****7. Select the “etc” folder****8. Select the “eGTouchd.ini” file**

### 9. Select “Display”

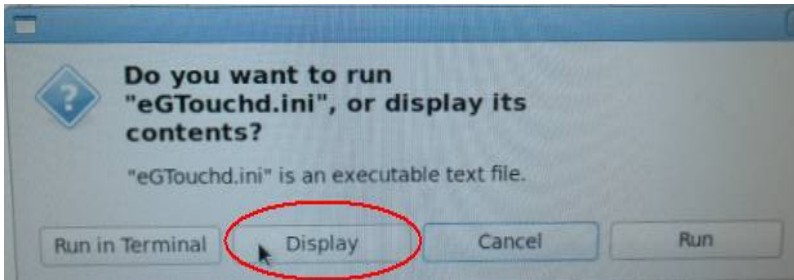

### 10. Modify the value of “Direction” from 0(default)→2(setting)

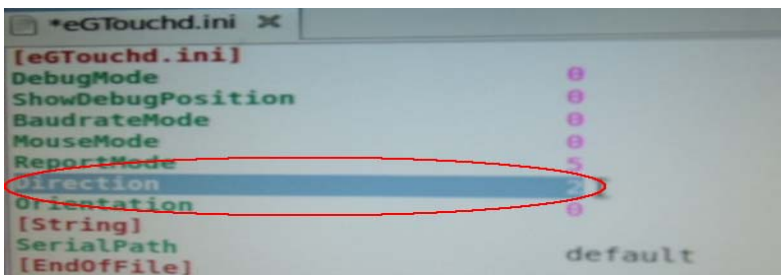
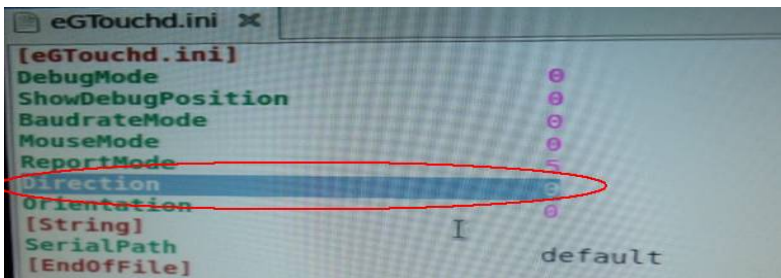



## 11. Execute "Save"

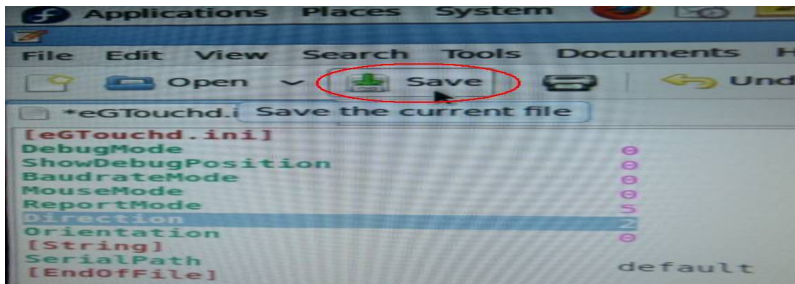

**Note:** If you want to change X or Y axis, please refer to the description of "Direction" as red circle below.

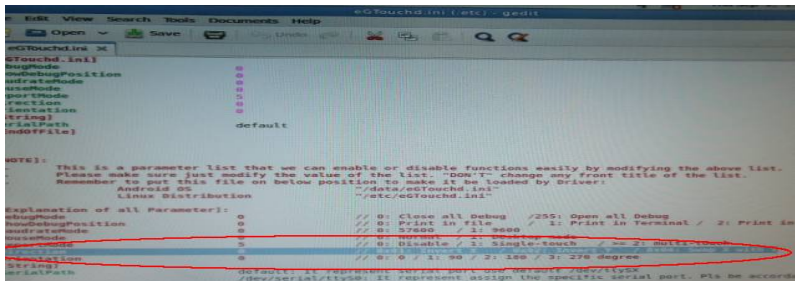

## 12. Reboot

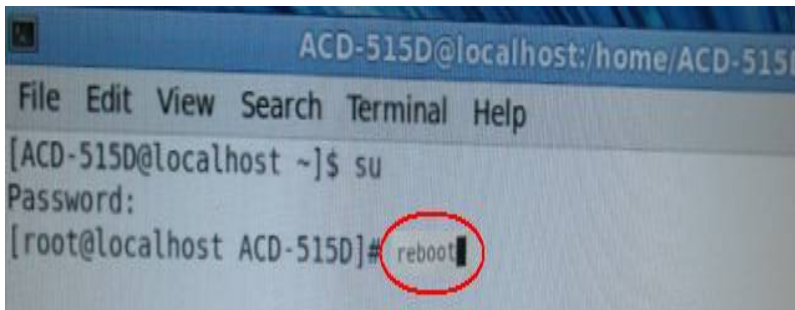

13. Input command → `./eGTouch` (Execute Driver) and select the file of “`eGTouch32`”.

13-1. Input command → `./EventTest` (Execute AP)



```
ACD-515D@localhost:/home/ACD-515D/Desktop/eGTouch_v1.00.0726.L-x32/
File Edit View Search Terminal Help
[ACD-515D@localhost ~]$ su
Password:
[root@localhost ACD-515D]# cd '/home/ACD-515D/Desktop/eGTouch_v1.00.0726.L-x32/eGTouch32'
[root@localhost eGTouch32]# ./eGTouchd
[root@localhost eGTouch32]# ./EventTest
```

14. Draw and test (Drawing · Writing)

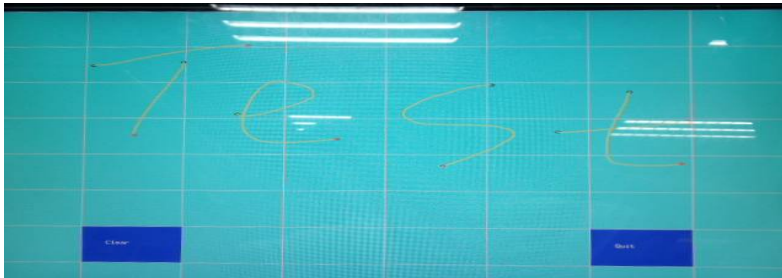

15. If you want to replace the Interface, please remove the Touchd Driver

Input command → `sh setup.sh uninstall` (Must Under `eGTouch_v1.00.0726.L-x32` folder under)



```
ACD-515D@localhost:/home/ACD-515D/Desktop/eGTouch_v1.00.0726.L-x32/
File Edit View Search Terminal Help
[ACD-515D@localhost ~]$ su
Password:
[root@localhost ACD-515D]# cd '/home/ACD-515D/Desktop/eGTouch_v1.00.0726.L-x32'
[root@localhost eGTouch_v1.00.0726.L-x32]# sh setup.sh uninstall
```

## 16. Reboot

```
ACD-515D@localhost:/home/ACD-515D/Desktop/eGTouch_v1.00.0726.L-x32
File Edit View Search Terminal Help

(*) Linux eGTouch driver installer for eGalaxTouch controller
(I) Check user permission: root, you are the supervisor.
(I) Begin to remove eGTouch driver.
(I) Removed eGTouch driver archive from /usr/local/eGTouch32.
(I) Removed eGTouchd.ini file from /etc.
(I) Removed eGTouchd shortcut from /usr/bin.
(I) Removed EventTest shortcut from /usr/bin.
(I) Removed eGTouch daemon from /etc/rc.local.
(I) Removed udev rule: /usr/share/X11/xorg.conf.d/52-egalax-virtual.conf.

(I) The eGTouch driver has been removed successfully.
(I) Please reboot the system for some changes to take effect.

[root@localhost eGTouch_v1.00.0726.L-x32]# reboot
```